

Contents

CABLE STAPLES	2
ROUND CABLE STAPLES	7
STAINLESS STEEL CABLE STAPLES	9
STAINLESS STEEL STRAPS	11A
PLASTIC STAPLES	12
COAXIAL STAPLES	12
LOW VOLTAGE INSULATED STAPLES	13
LOW VOLTAGE PLASTIC STAPLES	13
SERVICE ENTRANCE KITS	14
DRIVE STRAPS	15
PLASTIC CONDUIT STRAPS	15
THIN WALL CONDUIT STRAPS	16
FOLD OVER STRAPS	16
SERVICE ENTRANCE CABLE STRAPS	17
SERVICE ENTRANCE ROUND CABLE STRAPS	17
MIDGET STRAPS	18
NON-WATERTIGHT CONNECTORS	19
WATERTIGHT CONNECTORS	19
CABLE CONNECTORS	20
WEATHER CAPS	22
SILL PLATES	23
FISH WIRE	23
BOX SUPPORTS	24
STUD SAFETY PLATES	24
WIRE CONNECTORS	25
CLAMSHELLS	26
STAINLESS STEEL CLAMSHELLS	27

CABLE STAPLES

All Staple Sizes Are Inside Dimensions

SN 40

1/2" Wide, 1" Long, Low Carbon Steel

Armored Cable 14/2 And 14/3

Metal Clad 14/2 And 14/3

Non-metallic Sheathed 14/2 Through 10/3

Underground Feeder 14/2 And 12/2

CATALOG NUMBER	UPC # 780227	UNIT QUANTITY	MASTER CARTON	MASTER WEIGHT
SN 40 500	72403	500	10000	45
SN 40 5M	72405	5000	BUCKET	23
SN 40 J 1500	72404	1500 JAR	9000	41
SN 40 10M	72407	10000	BUCKET	45
SN 40 15M	72409	15000	BUCKET	63



SN 40 B

1/2" Wide, 1" Long, Zinc Plated Low Carbon Steel



Armored Cable 14/2 And 14/3

Metal Clad 14/2 And 14/3

Non-metallic Sheathed 14/2 Through 10/3

Underground Feeder 14/2 And 12/2

CATALOG NUMBER	UPC # 780227	UNIT QUANTITY	MASTER CARTON	MASTER WEIGHT
SN 40 B 100	71966	100	10000	45
SN 40 B 500	71968	500	10000	45
SN 40 BJ 1500	71969	1500 JAR	9000	41
SN 40 B 5M	71970	5000	BUCKET	23
SN 40 B 10M	71975	10000	BUCKET	45
SN 40 B 15M	71977	15000	BUCKET	63



SN 40 IB

1/2" Wide, 1" Long, Zinc Plated Low Carbon Steel, LDPE Blue Plastic Insulator



Armored Cable 14/2 And 14/3

Metal Clad 14/2 And 14/3

Non-metallic Sheathed 14/2 Through 10/3

Underground Feeder 14/2 And 12/2

CATALOG NUMBER	UPC # 780227	UNIT QUANTITY	MASTER CARTON	MASTER WEIGHT
SN 40 IB 100	71981	100	5000	27
SN 40 IB 500	71984	500	5000	27
SN 40 IBJ 500	71983	500 JAR	5000	27
SN 40 IB 2500	71980	2500	BUCKET	13
SN 40 IB 5M	71985	5000	BUCKET	26



SN 100

9/16" Wide, 1-1/4" Long, Low Carbon Steel

Armored Cable 14/2 Through 10/3

Metal Clad 14/2 Through 10/3

Non-metallic Sheathed 12/3 Through 10/3

Underground Feeder 14/3 And 12/3

CATALOG NUMBER	UPC # 780227	UNIT QUANTITY	MASTER CARTON	MASTER WEIGHT
SN 100 500	72993	500	5000	37
SN 100 J 1M	72983	1000 JAR	6000	42
SN 100 5M	72985	5000	BUCKET	35
SN 100 10M	72997	10000	BUCKET	70



SN 100 B

9/16" Wide, 1-1/4" Long, Zinc Plated Low Carbon Steel



Armored Cable 14/2 Through 10/3

Metal Clad 14/2 Through 10/3

Non-metallic Sheathed 12/3 Through 10/3

Underground Feeder 14/3 And 12/3

CATALOG NUMBER	UPC # 780227	UNIT QUANTITY	MASTER CARTON	MASTER WEIGHT
SN 100 B 100	71986	100	5000	37
SN 100 B 500	71995	500	5000	37
SN 100 BJ 1M	71987	1000 JAR	6000	44
SN 100 B 4M	71990	4000	BUCKET	30



SN 100 IB

9/16" Wide, 1-1/4" Long, Zinc Plated Low Carbon Steel, LDPE Yellow Plastic Insulator

Armored Cable 14/2 Through 10/3
 Non-metallic Sheathed 14/2 Through 10/3
 Non-metallic Sheathed 14/3 Parallel (Flat)

Metal Clad 14/2 Through 10/3
 Underground Feeder 14/2 Through 12/3

CATALOG NUMBER	UPC #	UNIT QUANTITY	MASTER CARTON	MASTER WEIGHT
SN 100 IB 100	72610	100	2000	18
SN 100 IB 250	72613	250	2500	22
SN 100 IB 3M	72615	3000	BUCKET	27



SN 150 B

1/2" Wide, 1-1/2" Long, Zinc Plated Low Carbon Steel,
 Extra Long For Securing Up To Two Cables



One Cable

Non-metallic Sheathed 14/2 Through 10/3
 Underground Feeder 14/2 And 12/2

Two Cables

Non-metallic Sheathed 14/2 Through 12/3
 Underground Feeder 14/2 And 12/2

CATALOG NUMBER	UPC #	UNIT QUANTITY	MASTER CARTON	MASTER WEIGHT
SN 150 B 100	75025	100	5000	44
SN 150 B 500	75030	500	5000	44
SN 150 B 2500	75035	2500	BUCKET	22



SN 150 IB

1/2" Wide, 1-1/2" Long, Zinc Plated Low Carbon Steel,
 LDPE Red Plastic Insulator, Extra Long For Securing Up To Two Cables



One Cable

Non-metallic Sheathed 14/2 Through 10/3
 Underground Feeder 14/2 And 12/2

Two Cables

Non-metallic Sheathed 14/2 Through 12/3
 Underground Feeder 14/2 And 12/2

CATALOG NUMBER	UPC #	UNIT QUANTITY	MASTER CARTON	MASTER WEIGHT
SN 150 IB 100	75027	100	5000	51
SN 150 IB 250	75028	250	2500	25
SN 150 IB 3M	75026	3000	BUCKET	29



SN 300 B

13/16" Wide, 1-3/8" Long, Zinc Plated Low Carbon Steel



Armored Cable 8/3 Metal Clad 8/3 SE Cable 8/2 Through 6/3
 Non-metallic Sheathed 8/3 Through 6/3 Underground Feeder 10/3

CATALOG NUMBER	UPC #	UNIT QUANTITY	MASTER CARTON	MASTER WEIGHT
SN 300 B 100	73302	100	5000	65



SN 300 IB

13/16" Wide, 1-3/8" Long, Zinc Plated Low Carbon Steel, LDPE Grey Plastic Insulator



Armored Cable 8/3 Metal Clad 8/3 SE Cable 8/2 Through 6/3
 Non-metallic Sheathed 8/3 Through 6/3 Underground Feeder 10/3

CATALOG NUMBER	UPC #	UNIT QUANTITY	MASTER CARTON	MASTER WEIGHT
SN 300 IB 100	73305	100	1000	16
SN 300 IBJ 175	75312	175	1750	29



SN 350 B

1-1/16" Wide, 1-7/16" Long, Zinc Plated Low Carbon Steel



SE Cable 4/3 SEU Through 2/3 SER

CATALOG NUMBER	UPC #	UNIT QUANTITY	MASTER CARTON	MASTER WEIGHT
SN 350 B 100	73350	100	2000	30



SN 350 IB

1-1/16" Wide, 1-7/16" Long, Zinc Plated Low Carbon Steel, LDPE Grey Plastic Insulator

SE Cable 4/3 SEU Through 2/3 SER

CATALOG NUMBER	UPC #	UNIT QUANTITY	MASTER CARTON	MASTER WEIGHT
SN 350 IB 50	73356	50	1000	18



#1 IN FASTENING THE POWER

SN 400 B

1-11/32" Wide, 1-7/8" Long, Zinc Plated Low Carbon Steel



SE Cable 3 No. 2/0 SEU SE Cable 3 No. 2/0 SER

CATALOG NUMBER	UPC #	UNIT QUANTITY	MASTER CARTON	MASTER WEIGHT
SN 400 B 100	73400	100	1000	32



SN 450 B

1-3/16" Wide, 2-1/4" Long, Zinc Plated Low Carbon Steel



Armored Cable 2/3 SE Cable 3 No. 1/0 SER Underground Feeder 6/3

CATALOG NUMBER	UPC #	UNIT QUANTITY	MASTER CARTON	MASTER WEIGHT
SN 450 B 100	73450	100	1000	35



SN 500 B

1-5/8" Wide, 2-1/8" Long, Zinc Plated Low Carbon Steel



SE Cable 3 No. 4/0 SEU SE Cable 3 No. 4/0 SER

CATALOG NUMBER	UPC #	UNIT QUANTITY	MASTER CARTON	MASTER WEIGHT
SN 500 B 100	73500	100	1000	37



ROUND CABLE STAPLES

SN 600

1-1/16" Wide, 2-1/16" Long, Zinc Plated Low Carbon Steel

4/3 SER Cable 2/3 SER Cable 3/4" EMT 1/2" Greenfield

CATALOG NUMBER	UPC #	UNIT QUANTITY	MASTER CARTON	MASTER WEIGHT
SN 600 100	74600	100	1000	29



SN 700

1-11/32" Wide, 2-11/32" Long, Zinc Plated Low Carbon Steel

2/0 SER Cable 1" EMT 1" Greenfield

CATALOG NUMBER	UPC #	UNIT QUANTITY	MASTER CARTON	MASTER WEIGHT
SN 700 100	74700	100	1000	35



SN 800

1-3/16" Wide, 2-3/16" Long, Zinc Plated Low Carbon Steel

2/3 BX 1" EMT 1" Greenfield 2/3 SER Cable

CATALOG NUMBER	UPC #	UNIT QUANTITY	MASTER CARTON	MASTER WEIGHT
SN 800 100	74800	100	1000	38



SN 900

1-5/8" Wide, 2-5/8" Long, Zinc Plated Low Carbon Steel

4/0 SER Cable 1" And 1-1/4" EMT Large BX And NM Greenfield

CATALOG NUMBER	UPC #	UNIT QUANTITY	MASTER CARTON	MASTER WEIGHT
SN 900 100	74900	100	1000	40



SN 1000

1-1/4" Wide, 2-3/4" Long, Zinc Plated Low Carbon Steel
Heavy Duty; Ideal For Wood Reels And Multiple Wiring

Large Metal Clad And Non-metallic Cable Greenfield

CATALOG NUMBER	UPC #	UNIT QUANTITY	MASTER CARTON	MASTER WEIGHT
SN 1000 20	75000	20	400	32



STAINLESS STEEL CABLE STAPLES

For Use On Pressure Treated Lumber And Exterior Applications

SN 40 B SS

1/2" Wide, 1" Long, Stainless Steel



Armored Cable 14/2 And 14/3

Metal Clad 14/2 And 14/3

Non-metallic Sheathed 14/2 Through 10/3

Underground Feeder 14/2 And 12/2

CATALOG NUMBER	UPC #	UNIT QUANTITY	MASTER CARTON	MASTER WEIGHT
SN 40 B SS 100	10035	100	10000	45



SN 40 IB SS

1/2" Wide, 1" Long, Stainless Steel, LDPE Blue Plastic Insulator



Armored Cable 14/2 And 14/3

Metal Clad 14/2 And 14/3

Non-metallic Sheathed 14/2 Through 10/3

Underground Feeder 14/2 And 12/2

CATALOG NUMBER	UPC #	UNIT QUANTITY	MASTER CARTON	MASTER WEIGHT
SN 40 IB SS 100	10030	100	5000	27



SN 100 B SS

9/16" Wide, 1-1/4" Long, Stainless Steel



Armored Cable 14/2 Through 10/3

Metal Clad 14/2 Through 10/3

Non-metallic Sheathed 12/3 Through 10/3

Underground Feeder 14/3 And 12/3

CATALOG NUMBER	UPC #	UNIT QUANTITY	MASTER CARTON	MASTER WEIGHT
SN 100 B SS 100	71997	100	5000	37



SN 100 IB SS

9/16" Wide, 1-1/4" Long, Stainless Steel, LDPE Yellow Plastic Insulator

Armored Cable 14/2 Through 10/3 Metal Clad 14/2 Through 10/3
 Non-metallic Sheathed 14/2 Through 10/3 Underground Feeder 14/2 Through 12/3
 Non-metallic Sheathed 14/3 Parallel (Flat)

CATALOG NUMBER	UPC #	UNIT QUANTITY	MASTER CARTON	MASTER WEIGHT
SN 100 IB SS 100	72617	100	2000	18



SN 150 B SS

1/2" Wide, 1-1/2" Long, Stainless Steel
 Extra Long For Securing Up To Two Cables

One Cable Two Cables
 Non-metallic Sheathed 14/2 Through 10/3 Non-metallic Sheathed 14/2 Through 12/3
 Underground Feeder 14/2 And 12/2 Underground Feeder 14/2 And 12/2

CATALOG NUMBER	UPC #	UNIT QUANTITY	MASTER CARTON	MASTER WEIGHT
SN 150 B SS 100	75041	100	5000	44



SN 150 IB SS

1/2" Wide, 1-1/2" Long, Stainless Steel, LDPE Red Plastic Insulator
 Extra Long For Securing Up To Two Cables

One Cable Two Cables
 Non-metallic Sheathed 14/2 Through 10/3 Non-metallic Sheathed 14/2 Through 12/3
 Underground Feeder 14/2 And 12/2 Underground Feeder 14/2 And 12/2

CATALOG NUMBER	UPC #	UNIT QUANTITY	MASTER CARTON	MASTER WEIGHT
SN 150 IB SS 100	75031	100	5000	51



SN 300 B SS

13/16" Wide, 1-3/8" Long, Stainless Steel



Armored Cable 8/3 Metal Clad 8/3 SE Cable 8/2 Through 6/3
 Non-metallic Sheathed 8/3 Through 6/3 Underground Feeder 10/3

CATALOG NUMBER	UPC #	UNIT QUANTITY	MASTER CARTON	MASTER WEIGHT
SN 300 B SS 100	73303	100	5000	65



SN 300 IB SS

13/16" Wide, 1-3/8" Long, Stainless Steel
 LDPE Grey Plastic Insulator



Armored Cable 8/3 Metal Clad 8/3 SE Cable 8/2 Through 6/3
 Non-metallic Sheathed 8/3 Through 6/3 Underground Feeder 10/3

CATALOG NUMBER	UPC #	UNIT QUANTITY	MASTER CARTON	MASTER WEIGHT
SN 300 IB SS 100	73308	100	1000	16



SN 350 B SS

1-1/16" Wide, 1-7/16" Long, Stainless Steel



SE Cable 4/3 SEU Through 2/3 SER

CATALOG NUMBER	UPC #	UNIT QUANTITY	MASTER CARTON	MASTER WEIGHT
SN 350 B SS 100	73353	100	2000	30



SN 350 IB SS

1-1/16" Wide, 1-7/16" Long, Stainless Steel
 LDPE Grey Plastic Insulator

SE Cable 4/3 SEU Through 2/3 SER

CATALOG NUMBER	UPC #	UNIT QUANTITY	MASTER CARTON	MASTER WEIGHT
SN 350 IB SS 50	73354	50	1000	18





STAINLESS STEEL MIDGET STRAPS

1-Hole Strap

CATALOG NUMBER	UPC #	CABLE SIZE	A	B	C	UNIT QTY	MASTER CARTON	MASTER WEIGHT
M 25 SS 100	69127	1/4" TUBING, #6 & #4 GROUND WIRE	3/8"	1/4"	3/16"	100	2000	18
M 30 SS 100	69126	14/2 TO 12/2 UF & NM SHEATHED	1/2"	1/4"	3/16"	100	2000	23
M 50 SS 100	69128	14/2 TO 10/3 MC	5/8"	1/2"	3/16"	100	2000	31

A = INSIDE WIDTH
 B = INSIDE HEIGHT
 C = HOLE DIAMETER

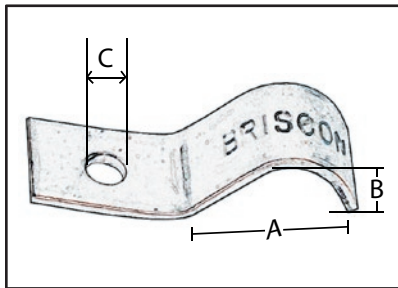

#1 IN FASTENING THE POWER



PLASTIC STAPLES

Plastic Saddles, Zinc Plated Nails Resist Rust And Corrosion

CATALOG NUMBER	UPC # 780227	CABLE SIZE	SADDLE COLOR	A	B	C	UNIT QTY	MASTER CARTON	MASTER WEIGHT
PS 50 100	72512	14/2 THROUGH 12/3 NM SHEATHED	WHITE	1/2"	3/16"	1-1/4"	100	2000	11
PS 75 100	72517	14/2 THROUGH 10/3 NM SHEATHED	WHITE	3/4"	3/16"	1-1/4"	100	2000	11
PS 300 100	41735	6/3 SEU	GREY	3/4"	3/8"	1-3/4"	100	1000	14
PS 300 R 100	41740	6/3 SER	GREY	3/4"	3/4"	1-3/4"	100	1000	15
PS 350 50	41745	2/3 SEU	GREY	1"	1/2"	1-3/4"	50	500	8
PS 350 R 50	41750	2/3 SER	GREY	1"	1"	2"	50	500	12
PS 400 R 50	41753	2/0 SER	GREY	1-1/4"	1-1/4"	2-1/2"	50	500	15
PS 500 50	41755	4/0 SEU	GREY	1-1/2"	1"	2"	50	500	12
PS 500 R 25	41760	4/0 SER	GREY	1-1/2"	1-1/2"	2"	25	250	9

A = INSIDE WIDTH
B = INSIDE HEIGHT
C = NAIL LENGTH

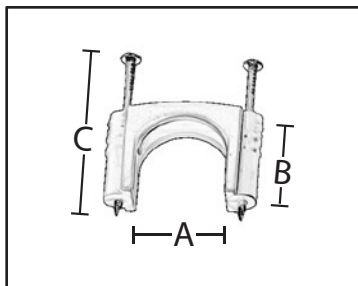

COAXIAL STAPLES

Use With RG-59, RG-6, Category 5 And Other Cables Up to 1/4"
Zinc Plated Nail And Staple Resist Rust And Corrosion

CATALOG NUMBER	UPC# 780227	DESCRIPTION WIDTH x LENGTH	UNIT QUANTITY	MASTER CARTON	MASTER WEIGHT
CX 90 100	75050	1/2" x 1" STAPLE	100	5000	34
CX 90 J 500	75056	1/2" x 1" STAPLE	500 JAR	5000	34
PS 90 B 100	72522	1/4" x 1" 1-NAIL BLACK	100	10000	26
PS 90 BJ 500	72524	1/4" x 1" 1-NAIL BLACK	500 JAR	5000	13
PS 90 W 100	72523	1/4" x 1" 1-NAIL WHITE	100	10000	26
PS 90 WJ 500	72525	1/4" x 1" 1-NAIL WHITE	500 JAR	5000	13



LOW VOLTAGE INSULATED STAPLES

Low Voltage Staples For Use With Bell, Speaker, Thermostat And Telephone Wire
All Sizes: Standard Package 1000 Staples; Approximate Weight 2 Pounds/1000

CATALOG NUMBER	UPC # 780227	UNIT QUANTITY	SIZE	DIMENSIONS WIDTH x LENGTH	FINISH
#1 COPPER 100	71137	100	# 1	3/16" x 1/2"	COPPERED
#3 COPPER 100	71337	100	# 3	3/16" x 3/4"	COPPERED
#5 BROWN 40	71512	40	# 5	1/4" x 5/8"	BROWN
#5 COPPER 100	71537	100	# 5	1/4" x 5/8"	COPPERED
#5 WHITE 40	71516	40	# 5	1/4" x 5/8"	WHITE
#6 COPPER 100	71637	100	# 6	1/4" x 3/4"	COPPERED
#7 COPPER 100	71737	100	# 7	1/4" x 7/8"	COPPERED

LOW VOLTAGE PLASTIC STAPLES

Low Voltage Staples For Use With Bell, Speaker, Thermostat And Telephone Wire
Zinc Plated Nail Resists Rust And Corrosion



CATALOG NUMBER	UPC # 780227	DESCRIPTION WIDTH x LENGTH	UNIT QUANTITY	MASTER CARTON	MASTER WEIGHT
PS 80 W 100	72541	3/16" x 1" 1-NAIL WHITE	100	10000	26
PS 80 B 100	72531	3/16" x 1" 1-NAIL BLACK	100	10000	26

SERVICE ENTRANCE KITS

Conveniently Packed For Fast Counter Service
Die Cast Or Plastic Weather Cap

SE 1 100 AMP

For 2/3 SEU Cable

CATALOG NUMBER: SE 1
UPC# 78022743950
MASTER CARTON: 10 KITS
MASTER WEIGHT: 13 lbs.

KIT CONTAINS:

- 1 #100 PLASTIC WEATHER CAP
- 10 4S2A CABLE STRAPS
- 1 WC 1252 1-1/4" WT CONNECTOR
- 2 125 SM 1-1/4" CONNECTORS
- 1 SP 28 SILL PLATE



SE 2 200 AMP

For 4/0 SEU Cable

CATALOG NUMBER: SE 2
UPC# 78022743960
MASTER CARTON: 10 KITS
MASTER WEIGHT: 35 lbs.

KIT CONTAINS:

- 1 #200 PLASTIC WEATHER CAP
- 10 4S0 2 CABLE STRAPS
- 1 WC 2004 2" WT CONNECTOR
- 2 200 SM 2" CONNECTORS
- 1 SP 40 SILL PLATE

SE 1 D 100 AMP

For 2/3 SEU Cable

CATALOG NUMBER: SE 1 D
UPC# 78022743955
MASTER CARTON: 10 KITS
MASTER WEIGHT: 13 lbs.

KIT CONTAINS:

- 1 DC 100 DIE CAST WEATHER CAP
- 10 4S2A CABLE STRAPS
- 1 WC 1252 1-1/4" WT CONNECTOR
- 2 125 SM 1-1/4" CONNECTORS
- 1 SP 28 SILL PLATE

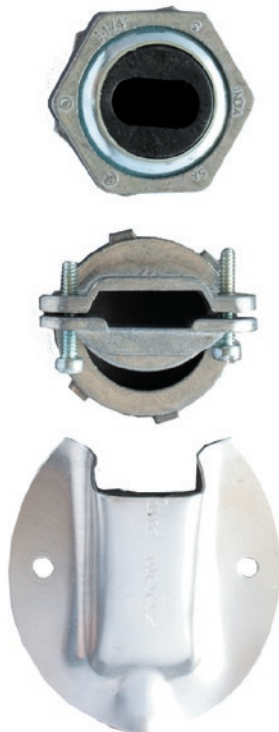

SE 2 D 200 AMP

For 4/0 SEU Cable

CATALOG NUMBER: SE 2 D
UPC# 78022743965
MASTER CARTON: 10 KITS
MASTER WEIGHT: 35 lbs.

KIT CONTAINS:

- 1 DC 200 DIE CAST WEATHER CAP
- 10 4S0 2 CABLE STRAPS
- 1 WC 2004 2" WT CONNECTOR
- 2 200 SM 2" CONNECTORS
- 1 SP 40 SILL PLATE

SE 1

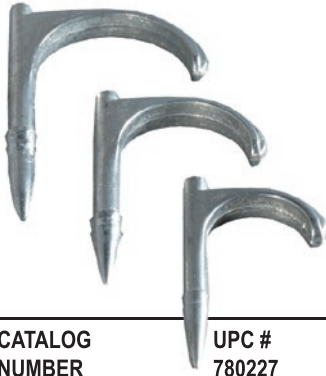

DRIVE STRAPS

Pressure Cast Zinc Drive Strap

CATALOG NUMBER	UPC # 780227	EMT SIZE	RIGID SIZE	A	B	C	UNIT QUANTITY	MASTER CARTON	MASTER WEIGHT
T5 100	35801	1/2"	3/8"	3/4"	3/8"	1-3/4"	100	2000	35
T7 100	35802	3/4"	1/2"	1"	1/2"	2"	100	2000	44
T10 100	35803	1"	3/4"	1-1/4"	5/8"	2-1/2"	100	1000	30

A = INSIDE WIDTH
B = INSIDE HEIGHT
C = NAIL LENGTH

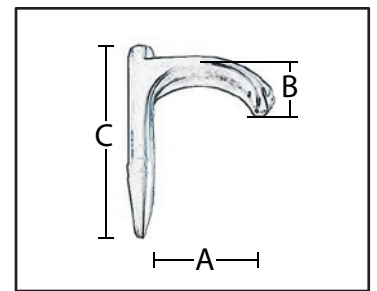

PLASTIC CONDUIT STRAPS

Grey Plastic 2-Hole Strap

CATALOG NUMBER	UPC # 780227	SIZE	A	B	C	UNIT QUANTITY	MASTER CARTON	MASTER WEIGHT
PS 5 50	41700	1/2"	7/8"	7/8"	1/4"	50	500	5
PS 7 50	41710	3/4"	1"	1"	1/4"	50	500	6
PS 10 50	41715	1"	1-3/16"	1-3/16"	1/4"	50	500	8
PS 12 25	41720	1-1/4"	1-5/8"	1-5/8"	1/4"	25	250	5
PS 15 25	41725	1-1/2"	1-7/8"	1-7/8"	1/4"	25	250	7
PS 20 10	41730	2"	2-3/8"	2-3/8"	1/4"	10	100	5
PS 25 5	41731	2-1/2"	3"	3"	3/8"	5	50	5
PS 30	41732	3"	3-1/2"	3-1/2"	3/8"	1	25	3
PS 40	41734	4"	4-1/2"	4-1/2"	3/8"	1	25	3

A = INSIDE WIDTH
B = INSIDE HEIGHT
C = HOLE DIAMETER

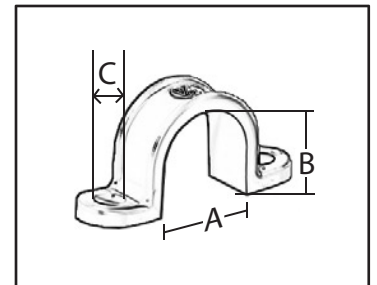

#1 IN FASTENING THE POWER



THIN WALL CONDUIT STRAPS

Galvanized Steel 1-Hole EMT Strap, Snap On Type

CATALOG NUMBER	UPC # 780227	SIZE	A	B	C	UNIT QUANTITY	MASTER CARTON	MASTER WEIGHT
TW 5 100	31601	1/2"	3/4"	3/4"	1/4"	100	1000	30
TW 7 100	31602	3/4"	7/8"	7/8"	1/4"	100	1000	37
TW 10 50	31603	1"	1-1/8"	1-1/8"	1/4"	50	500	25
TW 12 20	31604	1-1/4"	1-1/2"	1-1/4"	1/4"	20	200	19
TW 15 20	31605	1-1/2"	1-3/4"	1-5/8"	5/16"	20	200	33
TW 20 10	31606	2"	2-1/8"	1-7/8"	3/8"	10	100	17

A = INSIDE WIDTH
B = INSIDE HEIGHT
C = HOLE DIAMETER

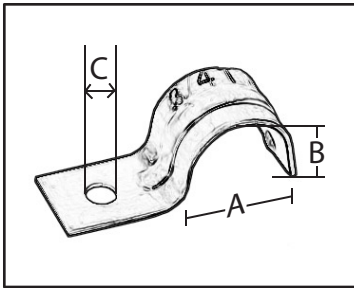

FOLD OVER STRAPS

Aluminum 1-Hole Strap. Fast And Easy Installation For Service Entrance Cable

CATALOG NUMBER	UPC # 780227	CABLE SIZE	A	B	C	UNIT QUANTITY	MASTER CARTON	MASTER WEIGHT
SC 15 100	43902	8/3 & 6/3	3/4"	1/2"	1/4"	100	1000	12
SC 20 100	43903	4/3	7/8"	1/2"	1/4"	100	1000	13
SC 25 100	43905	2/3	1"	5/8"	1/4"	100	1000	17
SC 35 50	43907	2/0	1-3/8"	3/4"	1/4"	50	500	15
SC 40 50	43909	4/0	1-1/2"	3/4"	1/4"	50	500	15

A = INSIDE WIDTH
B = INSIDE HEIGHT
C = HOLE DIAMETER

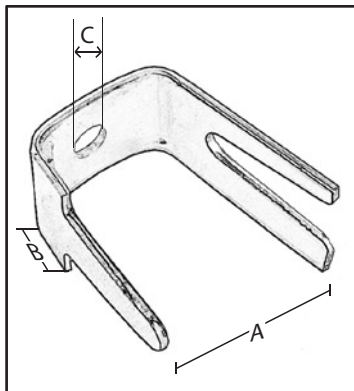



SERVICE ENTRANCE CABLE STRAPS

CATALOG NUMBER	UPC # 780227	MATERIAL	# HOLES	CABLE SIZE	A	B	C	UNIT QTY	MASTER CARTON	MASTER WEIGHT
6S1 100	41503	GALVANIZED STEEL	1	4/3 & 6/3	7/8"	1/2"	7/32"	100	1000	17
4S1 100	41505	GALVANIZED STEEL	1	2/3	1"	5/8"	1/4"	100	1000	34
1S0 50	41506	GALVANIZED STEEL	1	1/0	1-1/4"	3/4"	5/16"	50	500	30
2S0 50	41507	GALVANIZED STEEL	1	2/0	1-3/8"	3/4"	5/16"	50	500	32
4S0 50	41509	GALVANIZED STEEL	1	4/0	1-5/8"	3/4"	5/16"	50	500	32
6S2 100	41603	GALVANIZED STEEL	2	4/3 & 6/3	7/8"	1/2"	7/32"	100	1000	26
4S2 100	41605	GALVANIZED STEEL	2	2/3	1"	5/8"	7/32"	100	1000	27
4S2A 100	41608	ALUMINUM	2	2/3	1"	5/8"	7/32"	100	1000	11
1S0 2 50	43606	ALUMINUM	2	1/0	1-1/4"	11/16"	1/4"	50	500	12
2S0 2 50	43607	ALUMINUM	2	2/0	1-3/8"	3/4"	1/4"	50	500	12
4S0 2 50	43609	ALUMINUM	2	4/0	1-1/2"	3/4"	1/4"	50	500	13

A = INSIDE WIDTH
 B = INSIDE HEIGHT
 C = HOLE DIAMETER

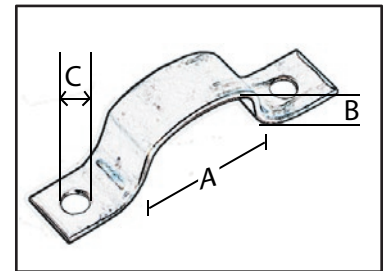

SERVICE ENTRANCE ROUND CABLE STRAPS

Aluminum 2-Hole Strap

CATALOG NUMBER	UPC # 780227	CABLE SIZE	A	B	C	UNIT QUANTITY	MASTER CARTON	MASTER WEIGHT
5S0 2 50	43608	2/3 SER	15/16"	15/16"	1/4"	50	500	11
6S0 2 25	43612	4/0 SER	1-1/2"	1-1/2"	1/4"	25	250	9

A = INSIDE WIDTH
 B = INSIDE HEIGHT
 C = HOLE DIAMETER

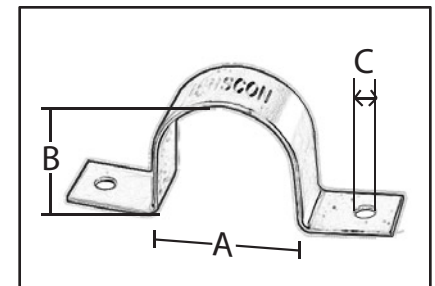

#1 IN FASTENING THE POWER



MIDGET STRAPS

Galvanized Steel 1-Hole Strap

CATALOG NUMBER	UPC #	CABLE SIZE	A	B	C	UNIT QTY	MASTER CARTON	MASTER WEIGHT
M 25 100	69124	1/4" TUBING, #6 & #4 GROUND WIRE	3/8"	1/4"	3/16"	100	2000	18
M 30 100	69123	14/2 TO 12/2 UF & NM SHEATHED	1/2"	1/4"	3/16"	100	2000	23
M 50 100	69125	14/2 TO 10/3 MC	5/8"	1/2"	3/16"	100	2000	31

A = INSIDE WIDTH
 B = INSIDE HEIGHT
 C = HOLE DIAMETER

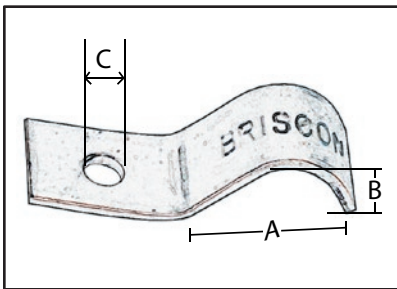



NON-WATERTIGHT CONNECTORS

Non-metallic And Service Entrance Cable; Oval Or Round
Zinc Die Cast 2-Screw Clamp Type

CATALOG NUMBER	UPC # 780227	SIZE	CABLE SIZE	KNOCKOUT SIZE	UNIT QUANTITY	MASTER CARTON	MASTER WEIGHT
75 SM/SMR 25	45602	3/4"	6/3 SEU/SER	3/4"	25	250	21
100 SM 25	45503	1"	4/3 SEU	1"	25	250	38
100 SMR 25	45603	1"	4/3 SER	1"	25	250	37
125 SM 10	45504	1-1/4"	2/3 SEU	1-1/4"	10	100	25
125 SMR 10	45604	1-1/4"	2/3 SER	1-1/4"	10	100	19
150 SM 10	45505	1-1/2"	2/0 SEU	1-1/2"	10	100	33
150 SMR 10	45605	1-1/2"	2/0 SER	1-1/2"	10	100	30
200 SM 5	45506	2"	4/0 SEU	2"	5	50	28
200 SMR 5	45606	2"	4/0 SER	2"	5	50	21



WATERTIGHT CONNECTORS

Service Entrance Cable

CATALOG NUMBER	UPC # 780227	SIZE	CABLE SIZE	GROMMET OPENING		UNIT QUANTITY	MASTER CARTON	MASTER WEIGHT
				MINIMUM	MAXIMUM			
WC 1006 15	45702	1"	6/3 SEU	0.32" x 0.50"	0.40" x 0.63"	15	150	35
WC 1004 15	45703	1"	4/3 SEU	0.40" x 0.71"	0.50" x 0.77"	15	150	35
WC 1252 15	45705	1-1/4"	2/3 SEU	0.51" x 0.93"	0.59" x 0.98"	15	150	60
WC 1252N 15	45715	1-1/4"	2/3 SEU	0.57" x 1.05"	0.65" x 1.09"	15	150	60
WC 1502 6	45707	1-1/2"	2/0 SEU	0.70" x 1.20"	0.86" x 1.34"	6	60	40
WC 1503 6	45708	1-1/2"	3/0 SEU	0.75" x 1.30"	0.87" x 1.37"	6	60	40
WC 2002 6	45717	2"	2/0 SEU	0.70" x 1.20"	0.86" x 1.34"	6	60	55
WC 2003 6	45718	2"	3/0 SEU	0.75" x 1.30"	0.87" x 1.37"	6	60	55
WC 2004 6	45709	2"	4/0 SEU	0.84" x 1.43"	0.90" x 1.50"	6	60	55

CABLE CONNECTORS

2 NC

Zinc Die Cast, 2-Screw Clamp Type, For (2) 14/2 Through (1) 10/2 Non-metallic Sheathed

CATALOG NUMBER	UPC #	SIZE	KNOCKOUT SIZE	UNIT QUANTITY	MASTER CARTON	MASTER WEIGHT
2 NC 100	45111	3/8"	1/2"	100	1000	47



1 AC

Zinc Die Cast, 1 Set Screw Type, For 3/8" Flex And Metal Clad Cable

CATALOG NUMBER	UPC #	SIZE	KNOCKOUT SIZE	UNIT QUANTITY	MASTER CARTON	MASTER WEIGHT
1 AC 100	45311	3/8"	1/2"	100	1000	45



90 M

Zinc Die Cast, 90° Angle, 2-Screw Clamp Type, For 3/8" Flex And Metal Clad Cable

CATALOG NUMBER	UPC #	SIZE	KNOCKOUT SIZE	UNIT QUANTITY	MASTER CARTON	MASTER WEIGHT
90 M 25	45191	3/8"	1/2"	25	250	23



2 BX

Zinc Die Cast, 1-Screw Saddle Type, For 3/8" Flex And Metal Clad Cable

CATALOG NUMBER	UPC #	SIZE	KNOCKOUT SIZE	UNIT QUANTITY	MASTER CARTON	MASTER WEIGHT
2 BX 50	45123	3/8"	1/2"	50	500	36



25 SM

Zinc Die Cast, Set Screw Type
Combination Coupling For EMT To Flex And Metal Clad Cable

CATALOG NUMBER	UPC #	SIZE	UNIT QUANTITY	MASTER CARTON	MASTER WEIGHT
25 SM 25	87760	3/8"	25	250	17



50 SM

Zinc Die Cast, Duplex Connector 1-Screw Clamp Type
For Non-metallic, Flex And Metal Clad Cable

CATALOG NUMBER	UPC #	SIZE	KNOCKOUT SIZE	UNIT QUANTITY	MASTER CARTON	MASTER WEIGHT
50 SM 25	87765	3/8"	1/2"	25	250	28





WEATHER CAPS Service Entrance Cable

Plastic Cap With Galvanized Steel Bracket And Clamp

CATALOG NUMBER	UPC #	CABLE SIZE	UNIT QUANTITY	MASTER CARTON	MASTER WEIGHT
# 100 6	47905	2/3	6	60	15
# 150 25	47907	2/0	1	25	13
# 200 25	47909	4/0	1	25	12

Aluminum Die Cast Cap With Galvanized Steel Clamp

CATALOG NUMBER	UPC #	CABLE SIZE	UNIT QUANTITY	MASTER CARTON	MASTER WEIGHT
DC 100 5	66100	8/3 THROUGH 2/3	5	50	14
DC 200 25	66200	1/0 THROUGH 4/0	1	25	24

Rigid Conduit And EMT

A Sleeve Is Furnished With Each Cap For Adaptation To EMT

CATALOG NUMBER	UPC #	CONDUIT SIZE	UNIT QUANTITY	MASTER CARTON	MASTER WEIGHT
5 WC	27701	1/2"	1	20	3
7 WC	27702	3/4"	1	20	4
10 WC	27703	1"	1	10	2
12 WC	27704	1-1/4"	1	10	3
15 WC	27705	1-1/2"	1	5	2
20 WC	27706	2"	1	5	5





SP 28

SILL PLATES

Complete With Duct Seal Compound And Zinc Plated Combination Head Screws

CATALOG NUMBER	UPC # 780227	MATERIAL	SEU CABLE SIZE	UNIT QUANTITY	MASTER CARTON	MASTER WEIGHT
SP 46 10	42903	ALUMINUM	4/3 & 6/3	10	100	10
SP 28 10	42905	ALUMINUM	2/3 & 3/3	10	100	10
SP 28P 10	42908	PLASTIC	2/3 & 3/3	10	100	10
SP 40 25	42909	CAST ALUMINUM	2/0 & 4/0	1	25	22



SP 40

FISH WIRE

Finest Quality

Flat, Oil Tempered Spring Steel, Flexible And Easy To Fish

0.125" Wide x 0.060" Thick

Individually Bagged 10 Bags Per Master Carton

FW 25 Bulk Packed; 25 Coils Per Carton

CATALOG NUMBER	UPC # 780227	LENGTH	MASTER WEIGHT
FW 25	85711	25'	16
FW 50	85721	50'	13
FW 100	85731	100'	26
FW 200	85741	200'	52



#1 IN FASTENING THE POWER



BOX SUPPORTS

Galvanized Steel

CATALOG NUMBER	UPC # 780227	DIMENSIONS			UNIT QUANTITY	MASTER CARTON	MASTER WEIGHT
		A	B	C			
BS 1 100 STANDARD	75070	5-1/4"	2-1/8"	1-1/2"	100 (50) PAIR	1000 (500) PAIR	22
BS 2 100 EXTRA LONG	75072	5-1/4"	3"	2-1/4"	100 (50) PAIR	1000 (500) PAIR	33

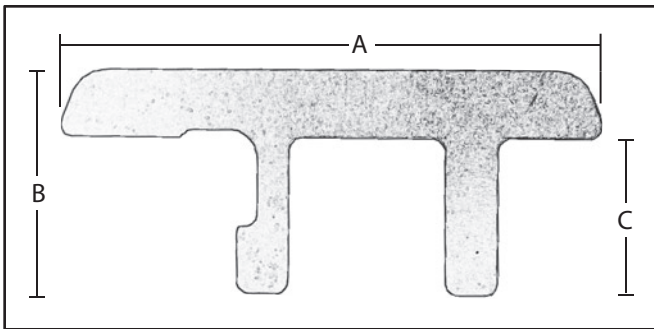

STUD SAFETY PLATES

16 Gauge Steel

CATALOG NUMBER	UPC # 780227	DIMENSIONS WIDTH x LENGTH	UNIT QUANTITY	MASTER CARTON	MASTER WEIGHT
SSP 2 50 EXTRA LONG	85737	1-5/8" x 5"	50	200	27

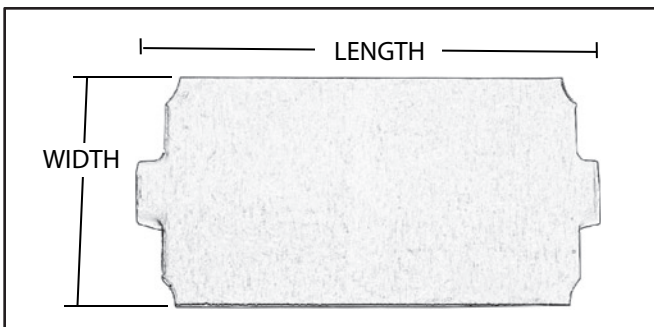



WIRE CONNECTORS

Color Coded For Easy Identification
Wire Spring Insert For Secure Connections

Three Sizes For Combinations From #10 Through #18 AWG
Rated At 600 Volts, Fixtures And Signs 1000 Volts
Temperature Rated At 105°C

CATALOG NUMBER	UPC #	SIZE	COLOR	UNIT QUANTITY	MASTER CARTON	MASTER WEIGHT
SWC 100	69111	SMALL	ORANGE	100	5000	12
MWC 100	69121	MEDIUM	YELLOW	100	5000	18
LWC 100	69131	LARGE	RED	100	2000	17

CLAMSHELLS

Briscon Quality And Name Recognition, Clamshells For Retail And Counter Sales,
Convenient Packaging For Both The Customer And Sales Person

Packaged 100 Clamshells Per Master Case

CATALOG NUMBER	UPC # 780227	DESCRIPTION WIDTH x LENGTH	PARTS PER PACKAGE	MASTER WEIGHT
SN 40 B 25	72401	1/2" x 1" ZINC PLATED STAPLE	25	15
SN 40 IB 20	71930	1/2" x 1" ZINC PLATED INSULATED STAPLE	20	15
SN 150 B 15	75036	1/2" x 1-1/2" ZINC PLATED STAPLE	15	17
SN 150 IB 10	75032	1/2" x 1-1/2" ZINC PLATED STAPLE	10	19
SN 100 B 15	72990	9/16" x 1-1/4" ZINC PLATED STAPLE	15	14
SN 100 IB 15	72611	9/16" x 1-1/4" ZINC PLATED INSULATED STAPLE	15	15
SN 300 B 10	73304	13/16" x 1-3/8" ZINC PLATED STAPLE	10	16
SN 300 IB 10	73306	13/16" x 1-3/8" ZINC PLATED INSULATED STAPLE	10	19
SN 350 B 10	73352	1-1/16" x 1-7/16" ZINC PLATED STAPLE	10	19
SN 350 IB 5	73357	1-1/16" x 1-7/16" ZINC PLATED INSULATED STAPLE	5	14
PS 50 20	72510	1/2" 2-NAIL PLASTIC STAPLE	20	15
PS 75 15	72515	3/4" 2-NAIL PLASTIC STAPLE	15	13
CX 90 20	75053	1/2" x 1" ZINC PLATED COAXIAL STAPLE	20	19
PS 90 B 25	72520	1-NAIL COAXIAL 1/4" BLACK PLASTIC STAPLE	25	9
PS 90 W 25	72521	1-NAIL COAXIAL 1/4" WHITE PLASTIC STAPLE	25	9
PS 80 B 25	72530	3/16" x 1" 1-NAIL BLACK LOW VOLTAGE PLASTIC STAPLE	25	9
PS 80 B 100	72531	3/16" x 1" 1-NAIL BLACK LOW VOLTAGE PLASTIC STAPLE	100	26
PS 80 W 25	72540	3/16" x 1" 1-NAIL WHITE LOW VOLTAGE PLASTIC STAPLE	25	9
PS 80 W 100	72541	3/16" x 1" 1-NAIL WHITE LOW VOLTAGE PLASTIC STAPLE	100	26
#5 BROWN 40 BP	71512	1/4" x 5/8" BROWN LOW VOLTAGE INSULATED STAPLE	40	11
#5 WHITE 40 BP	71516	1/4" x 5/8" WHITE LOW VOLTAGE INSULATED STAPLE	40	11

STAINLESS STEEL CLAMSHELLS

For Use On Pressure Treated Lumber And Exterior Applications

Packaged 100 Clamshells Per Master Case

CATALOG NUMBER	UPC #	DESCRIPTION WIDTH x LENGTH	PARTS PER PACKAGE	MASTER WEIGHT
SN 40 B SS 25	10036	1/2" x 1" STAINLESS STEEL STAPLE	25	15
SN 40 IB SS 20	10031	1/2" x 1" STAINLESS STEEL INSULATED STAPLE	20	15
SN 100 B SS 15	71988	9/16" x 1-1/4" STAINLESS STEEL STAPLE	15	14
SN 100 IB SS 15	72616	9/16" x 1-1/4" STAINLESS STEEL INSULATED STAPLE	15	15
SN 150 B SS 15	75042	1/2" x 1-1/2" STAINLESS STEEL STAPLE	15	17
SN 150 IB SS 10	75033	1/2" x 1-1/2" STAINLESS STEEL INSULATED STAPLE	10	19
SN 300 B SS 10	73309	13/16" x 1-3/8" STAINLESS STEEL STAPLE	10	16
SN 300 IB SS 10	73310	13/16" x 1-3/8" STAINLESS STEEL INSULATED STAPLE	10	19
SN 350 B SS 10	73358	1-1/16" x 1-7/16" STAINLESS STEEL STAPLE	10	19
SN 350 IB SS 5	73355	1-1/16" x 1-7/16" STAINLESS STEEL INSULATED STAPLE	5	14



Contents

CABLE STAPLES	2
ROUND CABLE STAPLES	7
STAINLESS STEEL CABLE STAPLES	9
STAINLESS STEEL STRAPS	11A
PLASTIC STAPLES	12
COAXIAL STAPLES	12
LOW VOLTAGE INSULATED STAPLES	13
LOW VOLTAGE PLASTIC STAPLES	13
SERVICE ENTRANCE KITS	14
DRIVE STRAPS	15
PLASTIC CONDUIT STRAPS	15
THIN WALL CONDUIT STRAPS	16
FOLD OVER STRAPS	16
SERVICE ENTRANCE CABLE STRAPS	17
SERVICE ENTRANCE ROUND CABLE STRAPS	17
MIDGET STRAPS	18
NON-WATERTIGHT CONNECTORS	19
WATERTIGHT CONNECTORS	19
CABLE CONNECTORS	20
WEATHER CAPS	22
SILL PLATES	23
FISH WIRE	23
BOX SUPPORTS	24
STUD SAFETY PLATES	24
WIRE CONNECTORS	25
CLAMSHELLS	26
STAINLESS STEEL CLAMSHELLS	27

CABLE STAPLES

All Staple Sizes Are Inside Dimensions

SN 40

1/2" Wide, 1" Long, Low Carbon Steel

Armored Cable 14/2 And 14/3

Metal Clad 14/2 And 14/3

Non-metallic Sheathed 14/2 Through 10/3

Underground Feeder 14/2 And 12/2

CATALOG NUMBER	UPC # 780227	UNIT QUANTITY	MASTER CARTON	MASTER WEIGHT
SN 40 500	72403	500	10000	45
SN 40 5M	72405	5000	BUCKET	23
SN 40 J 1500	72404	1500 JAR	9000	41
SN 40 10M	72407	10000	BUCKET	45
SN 40 15M	72409	15000	BUCKET	63



SN 40 B

1/2" Wide, 1" Long, Zinc Plated Low Carbon Steel



Armored Cable 14/2 And 14/3

Metal Clad 14/2 And 14/3

Non-metallic Sheathed 14/2 Through 10/3

Underground Feeder 14/2 And 12/2

CATALOG NUMBER	UPC # 780227	UNIT QUANTITY	MASTER CARTON	MASTER WEIGHT
SN 40 B 100	71966	100	10000	45
SN 40 B 500	71968	500	10000	45
SN 40 BJ 1500	71969	1500 JAR	9000	41
SN 40 B 5M	71970	5000	BUCKET	23
SN 40 B 10M	71975	10000	BUCKET	45
SN 40 B 15M	71977	15000	BUCKET	63



SN 40 IB

1/2" Wide, 1" Long, Zinc Plated Low Carbon Steel, LDPE Blue Plastic Insulator



Armored Cable 14/2 And 14/3

Metal Clad 14/2 And 14/3

Non-metallic Sheathed 14/2 Through 10/3

Underground Feeder 14/2 And 12/2

CATALOG NUMBER	UPC # 780227	UNIT QUANTITY	MASTER CARTON	MASTER WEIGHT
SN 40 IB 100	71981	100	5000	27
SN 40 IB 500	71984	500	5000	27
SN 40 IBJ 500	71983	500 JAR	5000	27
SN 40 IB 2500	71980	2500	BUCKET	13
SN 40 IB 5M	71985	5000	BUCKET	26



SN 100

9/16" Wide, 1-1/4" Long, Low Carbon Steel

Armored Cable 14/2 Through 10/3

Metal Clad 14/2 Through 10/3

Non-metallic Sheathed 12/3 Through 10/3

Underground Feeder 14/3 And 12/3

CATALOG NUMBER	UPC # 780227	UNIT QUANTITY	MASTER CARTON	MASTER WEIGHT
SN 100 500	72993	500	5000	37
SN 100 J 1M	72983	1000 JAR	6000	42
SN 100 5M	72985	5000	BUCKET	35
SN 100 10M	72997	10000	BUCKET	70



SN 100 B

9/16" Wide, 1-1/4" Long, Zinc Plated Low Carbon Steel



Armored Cable 14/2 Through 10/3

Metal Clad 14/2 Through 10/3

Non-metallic Sheathed 12/3 Through 10/3

Underground Feeder 14/3 And 12/3

CATALOG NUMBER	UPC # 780227	UNIT QUANTITY	MASTER CARTON	MASTER WEIGHT
SN 100 B 100	71986	100	5000	37
SN 100 B 500	71995	500	5000	37
SN 100 BJ 1M	71987	1000 JAR	6000	44
SN 100 B 4M	71990	4000	BUCKET	30



SN 100 IB

9/16" Wide, 1-1/4" Long, Zinc Plated Low Carbon Steel, LDPE Yellow Plastic Insulator

Armored Cable 14/2 Through 10/3
 Non-metallic Sheathed 14/2 Through 10/3
 Non-metallic Sheathed 14/3 Parallel (Flat)

Metal Clad 14/2 Through 10/3
 Underground Feeder 14/2 Through 12/3

CATALOG NUMBER	UPC #	UNIT QUANTITY	MASTER CARTON	MASTER WEIGHT
SN 100 IB 100	72610	100	2000	18
SN 100 IB 250	72613	250	2500	22
SN 100 IB 3M	72615	3000	BUCKET	27



SN 150 B

1/2" Wide, 1-1/2" Long, Zinc Plated Low Carbon Steel,
 Extra Long For Securing Up To Two Cables



One Cable

Non-metallic Sheathed 14/2 Through 10/3
 Underground Feeder 14/2 And 12/2

Two Cables

Non-metallic Sheathed 14/2 Through 12/3
 Underground Feeder 14/2 And 12/2

CATALOG NUMBER	UPC #	UNIT QUANTITY	MASTER CARTON	MASTER WEIGHT
SN 150 B 100	75025	100	5000	44
SN 150 B 500	75030	500	5000	44
SN 150 B 2500	75035	2500	BUCKET	22



SN 150 IB

1/2" Wide, 1-1/2" Long, Zinc Plated Low Carbon Steel,
 LDPE Red Plastic Insulator, Extra Long For Securing Up To Two Cables



One Cable

Non-metallic Sheathed 14/2 Through 10/3
 Underground Feeder 14/2 And 12/2

Two Cables

Non-metallic Sheathed 14/2 Through 12/3
 Underground Feeder 14/2 And 12/2

CATALOG NUMBER	UPC #	UNIT QUANTITY	MASTER CARTON	MASTER WEIGHT
SN 150 IB 100	75027	100	5000	51
SN 150 IB 250	75028	250	2500	25
SN 150 IB 3M	75026	3000	BUCKET	29



SN 300 B

13/16" Wide, 1-3/8" Long, Zinc Plated Low Carbon Steel



Armored Cable 8/3 Metal Clad 8/3 SE Cable 8/2 Through 6/3
 Non-metallic Sheathed 8/3 Through 6/3 Underground Feeder 10/3

CATALOG NUMBER	UPC #	UNIT QUANTITY	MASTER CARTON	MASTER WEIGHT
SN 300 B 100	73302	100	5000	65



SN 300 IB

13/16" Wide, 1-3/8" Long, Zinc Plated Low Carbon Steel, LDPE Grey Plastic Insulator



Armored Cable 8/3 Metal Clad 8/3 SE Cable 8/2 Through 6/3
 Non-metallic Sheathed 8/3 Through 6/3 Underground Feeder 10/3

CATALOG NUMBER	UPC #	UNIT QUANTITY	MASTER CARTON	MASTER WEIGHT
SN 300 IB 100	73305	100	1000	16
SN 300 IBJ 175	75312	175	1750	29



SN 350 B

1-1/16" Wide, 1-7/16" Long, Zinc Plated Low Carbon Steel



SE Cable 4/3 SEU Through 2/3 SER

CATALOG NUMBER	UPC #	UNIT QUANTITY	MASTER CARTON	MASTER WEIGHT
SN 350 B 100	73350	100	2000	30



SN 350 IB

1-1/16" Wide, 1-7/16" Long, Zinc Plated Low Carbon Steel, LDPE Grey Plastic Insulator

SE Cable 4/3 SEU Through 2/3 SER

CATALOG NUMBER	UPC #	UNIT QUANTITY	MASTER CARTON	MASTER WEIGHT
SN 350 IB 50	73356	50	1000	18



#1 IN FASTENING THE POWER

SN 400 B

1-11/32" Wide, 1-7/8" Long, Zinc Plated Low Carbon Steel



SE Cable 3 No. 2/0 SEU SE Cable 3 No. 2/0 SER

CATALOG NUMBER	UPC #	UNIT QUANTITY	MASTER CARTON	MASTER WEIGHT
SN 400 B 100	73400	100	1000	32



SN 450 B

1-3/16" Wide, 2-1/4" Long, Zinc Plated Low Carbon Steel



Armored Cable 2/3 SE Cable 3 No. 1/0 SER Underground Feeder 6/3

CATALOG NUMBER	UPC #	UNIT QUANTITY	MASTER CARTON	MASTER WEIGHT
SN 450 B 100	73450	100	1000	35



SN 500 B

1-5/8" Wide, 2-1/8" Long, Zinc Plated Low Carbon Steel



SE Cable 3 No. 4/0 SEU SE Cable 3 No. 4/0 SER

CATALOG NUMBER	UPC #	UNIT QUANTITY	MASTER CARTON	MASTER WEIGHT
SN 500 B 100	73500	100	1000	37



ROUND CABLE STAPLES

SN 600

1-1/16" Wide, 2-1/16" Long, Zinc Plated Low Carbon Steel

4/3 SER Cable 2/3 SER Cable 3/4" EMT 1/2" Greenfield

CATALOG NUMBER	UPC #	UNIT QUANTITY	MASTER CARTON	MASTER WEIGHT
SN 600 100	74600	100	1000	29



SN 700

1-11/32" Wide, 2-11/32" Long, Zinc Plated Low Carbon Steel

2/0 SER Cable 1" EMT 1" Greenfield

CATALOG NUMBER	UPC #	UNIT QUANTITY	MASTER CARTON	MASTER WEIGHT
SN 700 100	74700	100	1000	35



SN 800

1-3/16" Wide, 2-3/16" Long, Zinc Plated Low Carbon Steel

2/3 BX 1" EMT 1" Greenfield 2/3 SER Cable

CATALOG NUMBER	UPC #	UNIT QUANTITY	MASTER CARTON	MASTER WEIGHT
SN 800 100	74800	100	1000	38



SN 900

1-5/8" Wide, 2-5/8" Long, Zinc Plated Low Carbon Steel

4/0 SER Cable 1" And 1-1/4" EMT Large BX And NM Greenfield

CATALOG NUMBER	UPC #	UNIT QUANTITY	MASTER CARTON	MASTER WEIGHT
SN 900 100	74900	100	1000	40



SN 1000

1-1/4" Wide, 2-3/4" Long, Zinc Plated Low Carbon Steel
Heavy Duty; Ideal For Wood Reels And Multiple Wiring

Large Metal Clad And Non-metallic Cable Greenfield

CATALOG NUMBER	UPC #	UNIT QUANTITY	MASTER CARTON	MASTER WEIGHT
SN 1000 20	75000	20	400	32



STAINLESS STEEL CABLE STAPLES

For Use On Pressure Treated Lumber And Exterior Applications

SN 40 B SS

1/2" Wide, 1" Long, Stainless Steel



Armored Cable 14/2 And 14/3

Metal Clad 14/2 And 14/3

Non-metallic Sheathed 14/2 Through 10/3

Underground Feeder 14/2 And 12/2

CATALOG NUMBER	UPC #	UNIT QUANTITY	MASTER CARTON	MASTER WEIGHT
SN 40 B SS 100	10035	100	10000	45

**SN 40 IB SS**

1/2" Wide, 1" Long, Stainless Steel, LDPE Blue Plastic Insulator



Armored Cable 14/2 And 14/3

Metal Clad 14/2 And 14/3

Non-metallic Sheathed 14/2 Through 10/3

Underground Feeder 14/2 And 12/2

CATALOG NUMBER	UPC #	UNIT QUANTITY	MASTER CARTON	MASTER WEIGHT
SN 40 IB SS 100	10030	100	5000	27

**SN 100 B SS**

9/16" Wide, 1-1/4" Long, Stainless Steel



Armored Cable 14/2 Through 10/3

Metal Clad 14/2 Through 10/3

Non-metallic Sheathed 12/3 Through 10/3

Underground Feeder 14/3 And 12/3

CATALOG NUMBER	UPC #	UNIT QUANTITY	MASTER CARTON	MASTER WEIGHT
SN 100 B SS 100	71997	100	5000	37



SN 100 IB SS

9/16" Wide, 1-1/4" Long, Stainless Steel, LDPE Yellow Plastic Insulator

Armored Cable 14/2 Through 10/3 Metal Clad 14/2 Through 10/3
 Non-metallic Sheathed 14/2 Through 10/3 Underground Feeder 14/2 Through 12/3
 Non-metallic Sheathed 14/3 Parallel (Flat)

CATALOG NUMBER	UPC #	UNIT QUANTITY	MASTER CARTON	MASTER WEIGHT
SN 100 IB SS 100	72617	100	2000	18



SN 150 B SS

1/2" Wide, 1-1/2" Long, Stainless Steel
 Extra Long For Securing Up To Two Cables

One Cable Two Cables
 Non-metallic Sheathed 14/2 Through 10/3 Non-metallic Sheathed 14/2 Through 12/3
 Underground Feeder 14/2 And 12/2 Underground Feeder 14/2 And 12/2

CATALOG NUMBER	UPC #	UNIT QUANTITY	MASTER CARTON	MASTER WEIGHT
SN 150 B SS 100	75041	100	5000	44



SN 150 IB SS

1/2" Wide, 1-1/2" Long, Stainless Steel, LDPE Red Plastic Insulator
 Extra Long For Securing Up To Two Cables

One Cable Two Cables
 Non-metallic Sheathed 14/2 Through 10/3 Non-metallic Sheathed 14/2 Through 12/3
 Underground Feeder 14/2 And 12/2 Underground Feeder 14/2 And 12/2

CATALOG NUMBER	UPC #	UNIT QUANTITY	MASTER CARTON	MASTER WEIGHT
SN 150 IB SS 100	75031	100	5000	51



SN 300 B SS

13/16" Wide, 1-3/8" Long, Stainless Steel



Armored Cable 8/3 Metal Clad 8/3 SE Cable 8/2 Through 6/3
 Non-metallic Sheathed 8/3 Through 6/3 Underground Feeder 10/3

CATALOG NUMBER	UPC #	UNIT QUANTITY	MASTER CARTON	MASTER WEIGHT
SN 300 B SS 100	73303	100	5000	65



SN 300 IB SS

13/16" Wide, 1-3/8" Long, Stainless Steel
 LDPE Grey Plastic Insulator



Armored Cable 8/3 Metal Clad 8/3 SE Cable 8/2 Through 6/3
 Non-metallic Sheathed 8/3 Through 6/3 Underground Feeder 10/3

CATALOG NUMBER	UPC #	UNIT QUANTITY	MASTER CARTON	MASTER WEIGHT
SN 300 IB SS 100	73308	100	1000	16



SN 350 B SS

1-1/16" Wide, 1-7/16" Long, Stainless Steel



SE Cable 4/3 SEU Through 2/3 SER

CATALOG NUMBER	UPC #	UNIT QUANTITY	MASTER CARTON	MASTER WEIGHT
SN 350 B SS 100	73353	100	2000	30



SN 350 IB SS

1-1/16" Wide, 1-7/16" Long, Stainless Steel
 LDPE Grey Plastic Insulator

SE Cable 4/3 SEU Through 2/3 SER

CATALOG NUMBER	UPC #	UNIT QUANTITY	MASTER CARTON	MASTER WEIGHT
SN 350 IB SS 50	73354	50	1000	18





STAINLESS STEEL MIDGET STRAPS

1-Hole Strap

CATALOG NUMBER	UPC #	CABLE SIZE	A	B	C	UNIT QTY	MASTER CARTON	MASTER WEIGHT
M 25 SS 100	69127	1/4" TUBING, #6 & #4 GROUND WIRE	3/8"	1/4"	3/16"	100	2000	18
M 30 SS 100	69126	14/2 TO 12/2 UF & NM SHEATHED	1/2"	1/4"	3/16"	100	2000	23
M 50 SS 100	69128	14/2 TO 10/3 MC	5/8"	1/2"	3/16"	100	2000	31

A = INSIDE WIDTH
 B = INSIDE HEIGHT
 C = HOLE DIAMETER

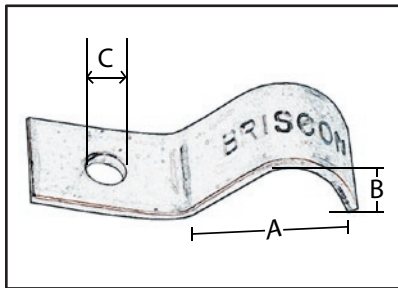



PLASTIC SADDLES

Plastic Saddles, Zinc Plated Nails Resist Rust And Corrosion

CATALOG NUMBER	UPC # 780227	CABLE SIZE	SADDLE COLOR	A	B	C	UNIT QTY	MASTER CARTON	MASTER WEIGHT
PS 50 100	72512	14/2 THROUGH 12/3 NM SHEATHED	WHITE	1/2"	3/16"	1-1/4"	100	2000	11
PS 75 100	72517	14/2 THROUGH 10/3 NM SHEATHED	WHITE	3/4"	3/16"	1-1/4"	100	2000	11
PS 300 100	41735	6/3 SEU	GREY	3/4"	3/8"	1-3/4"	100	1000	14
PS 300 R 100	41740	6/3 SER	GREY	3/4"	3/4"	1-3/4"	100	1000	15
PS 350 50	41745	2/3 SEU	GREY	1"	1/2"	1-3/4"	50	500	8
PS 350 R 50	41750	2/3 SER	GREY	1"	1"	2"	50	500	12
PS 400 R 50	41753	2/0 SER	GREY	1-1/4"	1-1/4"	2-1/2"	50	500	15
PS 500 50	41755	4/0 SEU	GREY	1-1/2"	1"	2"	50	500	12
PS 500 R 25	41760	4/0 SER	GREY	1-1/2"	1-1/2"	2"	25	250	9

A = INSIDE WIDTH
B = INSIDE HEIGHT
C = NAIL LENGTH

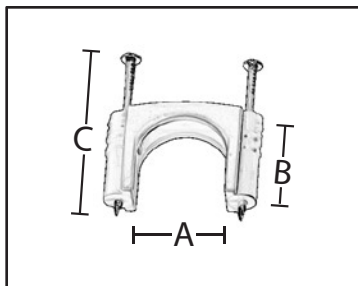

COAXIAL STAPLES

Use With RG-59, RG-6, Category 5 And Other Cables Up to 1/4"
Zinc Plated Nail And Staple Resist Rust And Corrosion

CATALOG NUMBER	UPC# 780227	DESCRIPTION WIDTH x LENGTH	UNIT QUANTITY	MASTER CARTON	MASTER WEIGHT
CX 90 100	75050	1/2" x 1" STAPLE	100	5000	34
CX 90 J 500	75056	1/2" x 1" STAPLE	500 JAR	5000	34
PS 90 B 100	72522	1/4" x 1" 1-NAIL BLACK	100	10000	26
PS 90 BJ 500	72524	1/4" x 1" 1-NAIL BLACK	500 JAR	5000	13
PS 90 W 100	72523	1/4" x 1" 1-NAIL WHITE	100	10000	26
PS 90 WJ 500	72525	1/4" x 1" 1-NAIL WHITE	500 JAR	5000	13



LOW VOLTAGE INSULATED STAPLES

Low Voltage Staples For Use With Bell, Speaker, Thermostat And Telephone Wire
All Sizes: Standard Package 1000 Staples; Approximate Weight 2 Pounds/1000

CATALOG NUMBER	UPC # 780227	UNIT QUANTITY	SIZE	DIMENSIONS WIDTH x LENGTH	FINISH
#1 COPPER 100	71137	100	# 1	3/16" x 1/2"	COPPERED
#3 COPPER 100	71337	100	# 3	3/16" x 3/4"	COPPERED
#5 BROWN 40	71512	40	# 5	1/4" x 5/8"	BROWN
#5 COPPER 100	71537	100	# 5	1/4" x 5/8"	COPPERED
#5 WHITE 40	71516	40	# 5	1/4" x 5/8"	WHITE
#6 COPPER 100	71637	100	# 6	1/4" x 3/4"	COPPERED
#7 COPPER 100	71737	100	# 7	1/4" x 7/8"	COPPERED

LOW VOLTAGE PLASTIC STAPLES

Low Voltage Staples For Use With Bell, Speaker, Thermostat And Telephone Wire
Zinc Plated Nail Resists Rust And Corrosion



CATALOG NUMBER	UPC # 780227	DESCRIPTION WIDTH x LENGTH	UNIT QUANTITY	MASTER CARTON	MASTER WEIGHT
PS 80 W 100	72541	3/16" x 1" 1-NAIL WHITE	100	10000	26
PS 80 B 100	72531	3/16" x 1" 1-NAIL BLACK	100	10000	26

SERVICE ENTRANCE KITS

Conveniently Packed For Fast Counter Service
Die Cast Or Plastic Weather Cap

SE 1 100 AMP

For 2/3 SEU Cable

CATALOG NUMBER: SE 1
UPC# 78022743950
MASTER CARTON: 10 KITS
MASTER WEIGHT: 13 lbs.

KIT CONTAINS:

- 1 #100 PLASTIC WEATHER CAP
- 10 4S2A CABLE STRAPS
- 1 WC 1252 1-1/4" WT CONNECTOR
- 2 125 SM 1-1/4" CONNECTORS
- 1 SP 28 SILL PLATE



SE 2 200 AMP

For 4/0 SEU Cable

CATALOG NUMBER: SE 2
UPC# 78022743960
MASTER CARTON: 10 KITS
MASTER WEIGHT: 35 lbs.

KIT CONTAINS:

- 1 #200 PLASTIC WEATHER CAP
- 10 4S0 2 CABLE STRAPS
- 1 WC 2004 2" WT CONNECTOR
- 2 200 SM 2" CONNECTORS
- 1 SP 40 SILL PLATE

SE 1 D 100 AMP

For 2/3 SEU Cable

CATALOG NUMBER: SE 1 D
UPC# 78022743955
MASTER CARTON: 10 KITS
MASTER WEIGHT: 13 lbs.

KIT CONTAINS:

- 1 DC 100 DIE CAST WEATHER CAP
- 10 4S2A CABLE STRAPS
- 1 WC 1252 1-1/4" WT CONNECTOR
- 2 125 SM 1-1/4" CONNECTORS
- 1 SP 28 SILL PLATE

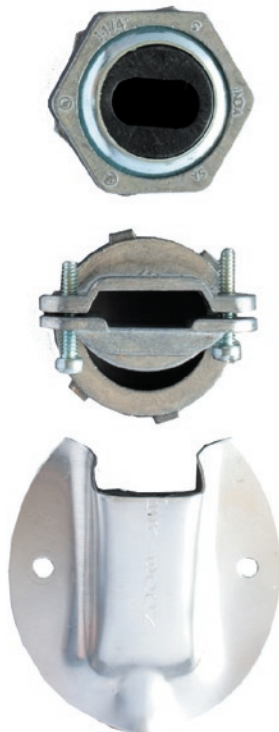

SE 2 D 200 AMP

For 4/0 SEU Cable

CATALOG NUMBER: SE 2 D
UPC# 78022743965
MASTER CARTON: 10 KITS
MASTER WEIGHT: 35 lbs.

KIT CONTAINS:

- 1 DC 200 DIE CAST WEATHER CAP
- 10 4S0 2 CABLE STRAPS
- 1 WC 2004 2" WT CONNECTOR
- 2 200 SM 2" CONNECTORS
- 1 SP 40 SILL PLATE

SE 1

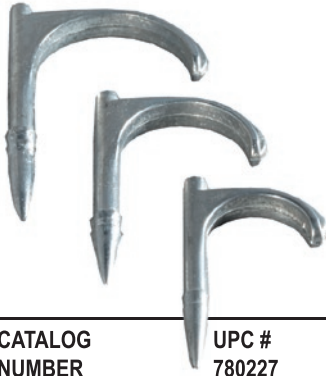

DRIVE STRAPS

Pressure Cast Zinc Drive Strap

CATALOG NUMBER	UPC # 780227	EMT SIZE	RIGID SIZE	A	B	C	UNIT QUANTITY	MASTER CARTON	MASTER WEIGHT
T5 100	35801	1/2"	3/8"	3/4"	3/8"	1-3/4"	100	2000	35
T7 100	35802	3/4"	1/2"	1"	1/2"	2"	100	2000	44
T10 100	35803	1"	3/4"	1-1/4"	5/8"	2-1/2"	100	1000	30

A = INSIDE WIDTH
B = INSIDE HEIGHT
C = NAIL LENGTH

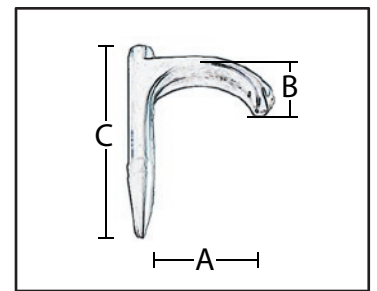

PLASTIC CONDUIT STRAPS

Grey Plastic 2-Hole Strap

CATALOG NUMBER	UPC # 780227	SIZE	A	B	C	UNIT QUANTITY	MASTER CARTON	MASTER WEIGHT
PS 5 50	41700	1/2"	7/8"	7/8"	1/4"	50	500	5
PS 7 50	41710	3/4"	1"	1"	1/4"	50	500	6
PS 10 50	41715	1"	1-3/16"	1-3/16"	1/4"	50	500	8
PS 12 25	41720	1-1/4"	1-5/8"	1-5/8"	1/4"	25	250	5
PS 15 25	41725	1-1/2"	1-7/8"	1-7/8"	1/4"	25	250	7
PS 20 10	41730	2"	2-3/8"	2-3/8"	1/4"	10	100	5
PS 25 5	41731	2-1/2"	3"	3"	3/8"	5	50	5
PS 30	41732	3"	3-1/2"	3-1/2"	3/8"	1	25	3
PS 40	41734	4"	4-1/2"	4-1/2"	3/8"	1	25	3

A = INSIDE WIDTH
B = INSIDE HEIGHT
C = HOLE DIAMETER

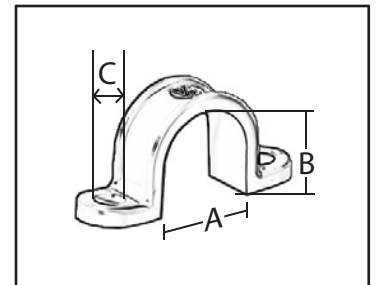

#1 IN FASTENING THE POWER



THIN WALL CONDUIT STRAPS

Galvanized Steel 1-Hole EMT Strap, Snap On Type

CATALOG NUMBER	UPC # 780227	SIZE	A	B	C	UNIT QUANTITY	MASTER CARTON	MASTER WEIGHT
TW 5 100	31601	1/2"	3/4"	3/4"	1/4"	100	1000	30
TW 7 100	31602	3/4"	7/8"	7/8"	1/4"	100	1000	37
TW 10 50	31603	1"	1-1/8"	1-1/8"	1/4"	50	500	25
TW 12 20	31604	1-1/4"	1-1/2"	1-1/4"	1/4"	20	200	19
TW 15 20	31605	1-1/2"	1-3/4"	1-5/8"	5/16"	20	200	33
TW 20 10	31606	2"	2-1/8"	1-7/8"	3/8"	10	100	17

A = INSIDE WIDTH
B = INSIDE HEIGHT
C = HOLE DIAMETER

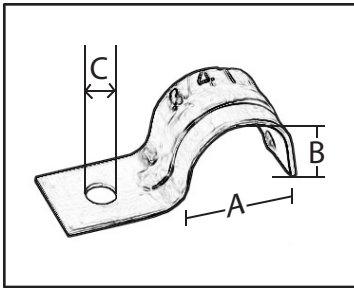

FOLD OVER STRAPS

Aluminum 1-Hole Strap. Fast And Easy Installation For Service Entrance Cable

CATALOG NUMBER	UPC # 780227	CABLE SIZE	A	B	C	UNIT QUANTITY	MASTER CARTON	MASTER WEIGHT
SC 15 100	43902	8/3 & 6/3	3/4"	1/2"	1/4"	100	1000	12
SC 20 100	43903	4/3	7/8"	1/2"	1/4"	100	1000	13
SC 25 100	43905	2/3	1"	5/8"	1/4"	100	1000	17
SC 35 50	43907	2/0	1-3/8"	3/4"	1/4"	50	500	15
SC 40 50	43909	4/0	1-1/2"	3/4"	1/4"	50	500	15

A = INSIDE WIDTH
B = INSIDE HEIGHT
C = HOLE DIAMETER

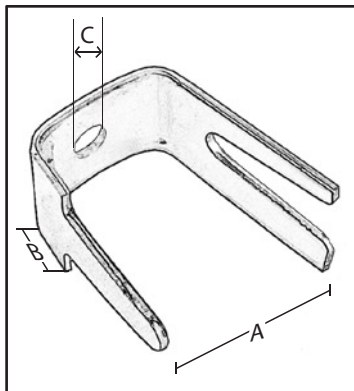



SERVICE ENTRANCE CABLE STRAPS

CATALOG NUMBER	UPC # 780227	MATERIAL	# HOLES	CABLE SIZE	A	B	C	UNIT QTY	MASTER CARTON	MASTER WEIGHT
6S1 100	41503	GALVANIZED STEEL	1	4/3 & 6/3	7/8"	1/2"	7/32"	100	1000	17
4S1 100	41505	GALVANIZED STEEL	1	2/3	1"	5/8"	1/4"	100	1000	34
1S0 50	41506	GALVANIZED STEEL	1	1/0	1-1/4"	3/4"	5/16"	50	500	30
2S0 50	41507	GALVANIZED STEEL	1	2/0	1-3/8"	3/4"	5/16"	50	500	32
4S0 50	41509	GALVANIZED STEEL	1	4/0	1-5/8"	3/4"	5/16"	50	500	32
6S2 100	41603	GALVANIZED STEEL	2	4/3 & 6/3	7/8"	1/2"	7/32"	100	1000	26
4S2 100	41605	GALVANIZED STEEL	2	2/3	1"	5/8"	7/32"	100	1000	27
4S2A 100	41608	ALUMINUM	2	2/3	1"	5/8"	7/32"	100	1000	11
1S0 2 50	43606	ALUMINUM	2	1/0	1-1/4"	11/16"	1/4"	50	500	12
2S0 2 50	43607	ALUMINUM	2	2/0	1-3/8"	3/4"	1/4"	50	500	12
4S0 2 50	43609	ALUMINUM	2	4/0	1-1/2"	3/4"	1/4"	50	500	13

A = INSIDE WIDTH
 B = INSIDE HEIGHT
 C = HOLE DIAMETER

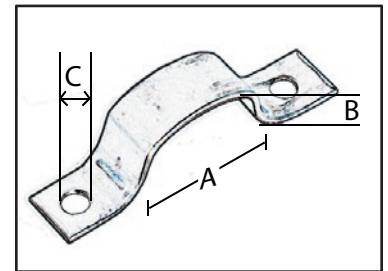

SERVICE ENTRANCE ROUND CABLE STRAPS

Aluminum 2-Hole Strap

CATALOG NUMBER	UPC # 780227	CABLE SIZE	A	B	C	UNIT QUANTITY	MASTER CARTON	MASTER WEIGHT
5S0 2 50	43608	2/3 SER	15/16"	15/16"	1/4"	50	500	11
6S0 2 25	43612	4/0 SER	1-1/2"	1-1/2"	1/4"	25	250	9

A = INSIDE WIDTH
 B = INSIDE HEIGHT
 C = HOLE DIAMETER

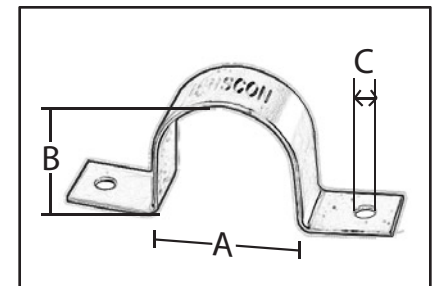

#1 IN FASTENING THE POWER



MIDGET STRAPS

Galvanized Steel 1-Hole Strap

CATALOG NUMBER	UPC #	CABLE SIZE	A	B	C	UNIT QTY	MASTER CARTON	MASTER WEIGHT
M 25 100	69124	1/4" TUBING, #6 & #4 GROUND WIRE	3/8"	1/4"	3/16"	100	2000	18
M 30 100	69123	14/2 TO 12/2 UF & NM SHEATHED	1/2"	1/4"	3/16"	100	2000	23
M 50 100	69125	14/2 TO 10/3 MC	5/8"	1/2"	3/16"	100	2000	31

A = INSIDE WIDTH
 B = INSIDE HEIGHT
 C = HOLE DIAMETER

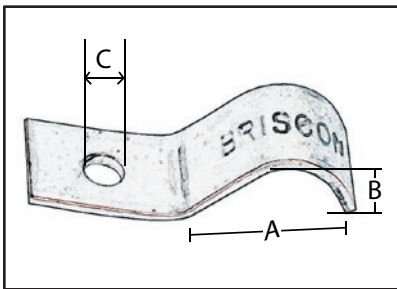



NON-WATERTIGHT CONNECTORS

Non-metallic And Service Entrance Cable; Oval Or Round
Zinc Die Cast 2-Screw Clamp Type

CATALOG NUMBER	UPC # 780227	SIZE	CABLE SIZE	KNOCKOUT SIZE	UNIT QUANTITY	MASTER CARTON	MASTER WEIGHT
75 SM/SMR 25	45602	3/4"	6/3 SEU/SER	3/4"	25	250	21
100 SM 25	45503	1"	4/3 SEU	1"	25	250	38
100 SMR 25	45603	1"	4/3 SER	1"	25	250	37
125 SM 10	45504	1-1/4"	2/3 SEU	1-1/4"	10	100	25
125 SMR 10	45604	1-1/4"	2/3 SER	1-1/4"	10	100	19
150 SM 10	45505	1-1/2"	2/0 SEU	1-1/2"	10	100	33
150 SMR 10	45605	1-1/2"	2/0 SER	1-1/2"	10	100	30
200 SM 5	45506	2"	4/0 SEU	2"	5	50	28
200 SMR 5	45606	2"	4/0 SER	2"	5	50	21



WATERTIGHT CONNECTORS

Service Entrance Cable

CATALOG NUMBER	UPC # 780227	SIZE	CABLE SIZE	GROMMET OPENING		UNIT QUANTITY	MASTER CARTON	MASTER WEIGHT
				MINIMUM	MAXIMUM			
WC 1006 15	45702	1"	6/3 SEU	0.32" x 0.50"	0.40" x 0.63"	15	150	35
WC 1004 15	45703	1"	4/3 SEU	0.40" x 0.71"	0.50" x 0.77"	15	150	35
WC 1252 15	45705	1-1/4"	2/3 SEU	0.51" x 0.93"	0.59" x 0.98"	15	150	60
WC 1252N 15	45715	1-1/4"	2/3 SEU	0.57" x 1.05"	0.65" x 1.09"	15	150	60
WC 1502 6	45707	1-1/2"	2/0 SEU	0.70" x 1.20"	0.86" x 1.34"	6	60	40
WC 1503 6	45708	1-1/2"	3/0 SEU	0.75" x 1.30"	0.87" x 1.37"	6	60	40
WC 2002 6	45717	2"	2/0 SEU	0.70" x 1.20"	0.86" x 1.34"	6	60	55
WC 2003 6	45718	2"	3/0 SEU	0.75" x 1.30"	0.87" x 1.37"	6	60	55
WC 2004 6	45709	2"	4/0 SEU	0.84" x 1.43"	0.90" x 1.50"	6	60	55

CABLE CONNECTORS

2 NC

Zinc Die Cast, 2-Screw Clamp Type, For (2) 14/2 Through (1) 10/2 Non-metallic Sheathed

CATALOG NUMBER	UPC #	SIZE	KNOCKOUT SIZE	UNIT QUANTITY	MASTER CARTON	MASTER WEIGHT
2 NC 100	45111	3/8"	1/2"	100	1000	47



1 AC

Zinc Die Cast, 1 Set Screw Type, For 3/8" Flex And Metal Clad Cable

CATALOG NUMBER	UPC #	SIZE	KNOCKOUT SIZE	UNIT QUANTITY	MASTER CARTON	MASTER WEIGHT
1 AC 100	45311	3/8"	1/2"	100	1000	45



90 M

Zinc Die Cast, 90° Angle, 2-Screw Clamp Type, For 3/8" Flex And Metal Clad Cable

CATALOG NUMBER	UPC #	SIZE	KNOCKOUT SIZE	UNIT QUANTITY	MASTER CARTON	MASTER WEIGHT
90 M 25	45191	3/8"	1/2"	25	250	23



2 BX

Zinc Die Cast, 1-Screw Saddle Type, For 3/8" Flex And Metal Clad Cable

CATALOG NUMBER	UPC #	SIZE	KNOCKOUT SIZE	UNIT QUANTITY	MASTER CARTON	MASTER WEIGHT
2 BX 50	45123	3/8"	1/2"	50	500	36



25 SM

Zinc Die Cast, Set Screw Type
Combination Coupling For EMT To Flex And Metal Clad Cable

CATALOG NUMBER	UPC #	SIZE	UNIT QUANTITY	MASTER CARTON	MASTER WEIGHT
25 SM 25	87760	3/8"	25	250	17



50 SM

Zinc Die Cast, Duplex Connector 1-Screw Clamp Type
For Non-metallic, Flex And Metal Clad Cable

CATALOG NUMBER	UPC #	SIZE	KNOCKOUT SIZE	UNIT QUANTITY	MASTER CARTON	MASTER WEIGHT
50 SM 25	87765	3/8"	1/2"	25	250	28



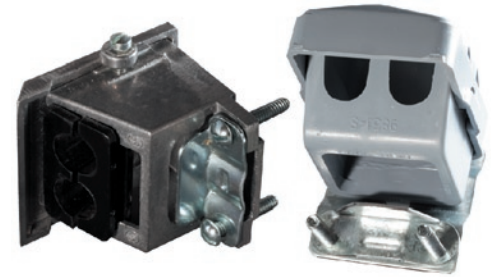

WEATHER CAPS Service Entrance Cable

Plastic Cap With Galvanized Steel Bracket And Clamp

CATALOG NUMBER	UPC #	CABLE SIZE	UNIT QUANTITY	MASTER CARTON	MASTER WEIGHT
# 100 6	47905	2/3	6	60	15
# 150 25	47907	2/0	1	25	13
# 200 25	47909	4/0	1	25	12

Aluminum Die Cast Cap With Galvanized Steel Clamp

CATALOG NUMBER	UPC #	CABLE SIZE	UNIT QUANTITY	MASTER CARTON	MASTER WEIGHT
DC 100 5	66100	8/3 THROUGH 2/3	5	50	14
DC 200 25	66200	1/0 THROUGH 4/0	1	25	24

Rigid Conduit And EMT

A Sleeve Is Furnished With Each Cap For Adaptation To EMT

CATALOG NUMBER	UPC #	CONDUIT SIZE	UNIT QUANTITY	MASTER CARTON	MASTER WEIGHT
5 WC	27701	1/2"	1	20	3
7 WC	27702	3/4"	1	20	4
10 WC	27703	1"	1	10	2
12 WC	27704	1-1/4"	1	10	3
15 WC	27705	1-1/2"	1	5	2
20 WC	27706	2"	1	5	5





SP 28

SILL PLATES

Complete With Duct Seal Compound And Zinc Plated Combination Head Screws

CATALOG NUMBER	UPC # 780227	MATERIAL	SEU CABLE SIZE	UNIT QUANTITY	MASTER CARTON	MASTER WEIGHT
SP 46 10	42903	ALUMINUM	4/3 & 6/3	10	100	10
SP 28 10	42905	ALUMINUM	2/3 & 3/3	10	100	10
SP 28P 10	42908	PLASTIC	2/3 & 3/3	10	100	10
SP 40 25	42909	CAST ALUMINUM	2/0 & 4/0	1	25	22



SP 40

FISH WIRE

Finest Quality

Flat, Oil Tempered Spring Steel, Flexible And Easy To Fish

0.125" Wide x 0.060" Thick
 Individually Bagged 10 Bags Per Master Carton
 FW 25 Bulk Packed; 25 Coils Per Carton

CATALOG NUMBER	UPC # 780227	LENGTH	MASTER WEIGHT
FW 25	85711	25'	16
FW 50	85721	50'	13
FW 100	85731	100'	26
FW 200	85741	200'	52



#1 IN FASTENING THE POWER



BOX SUPPORTS

Galvanized Steel

CATALOG NUMBER	UPC # 780227	DIMENSIONS			UNIT QUANTITY	MASTER CARTON	MASTER WEIGHT
		A	B	C			
BS 1 100 STANDARD	75070	5-1/4"	2-1/8"	1-1/2"	100 (50) PAIR	1000 (500) PAIR	22
BS 2 100 EXTRA LONG	75072	5-1/4"	3"	2-1/4"	100 (50) PAIR	1000 (500) PAIR	33

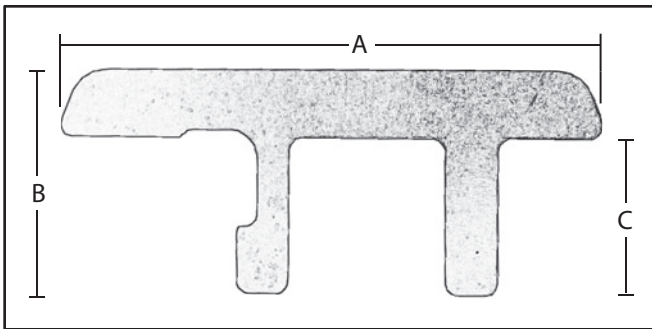

STUD SAFETY PLATES

16 Gauge Steel

CATALOG NUMBER	UPC # 780227	DIMENSIONS WIDTH x LENGTH	UNIT QUANTITY	MASTER CARTON	MASTER WEIGHT
SSP 2 50 EXTRA LONG	85737	1-5/8" x 5"	50	200	27

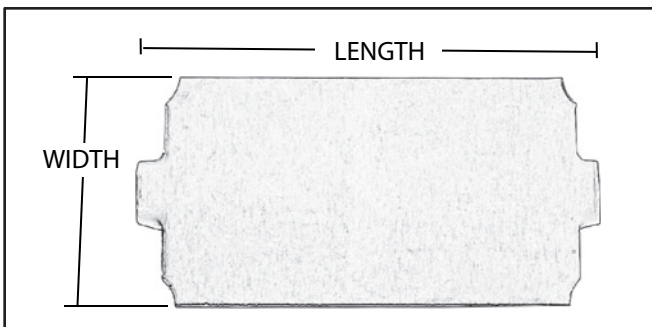



WIRE CONNECTORS

Color Coded For Easy Identification
Wire Spring Insert For Secure Connections

Three Sizes For Combinations From #10 Through #18 AWG
Rated At 600 Volts, Fixtures And Signs 1000 Volts
Temperature Rated At 105°C

CATALOG NUMBER	UPC #	SIZE	COLOR	UNIT QUANTITY	MASTER CARTON	MASTER WEIGHT
SWC 100	69111	SMALL	ORANGE	100	5000	12
MWC 100	69121	MEDIUM	YELLOW	100	5000	18
LWC 100	69131	LARGE	RED	100	2000	17

CLAMSHELLS

Briscon Quality And Name Recognition, Clamshells For Retail And Counter Sales,
Convenient Packaging For Both The Customer And Sales Person

Packaged 100 Clamshells Per Master Case

CATALOG NUMBER	UPC # 780227	DESCRIPTION WIDTH x LENGTH	PARTS PER PACKAGE	MASTER WEIGHT
SN 40 B 25	72401	1/2" x 1" ZINC PLATED STAPLE	25	15
SN 40 IB 20	71930	1/2" x 1" ZINC PLATED INSULATED STAPLE	20	15
SN 150 B 15	75036	1/2" x 1-1/2" ZINC PLATED STAPLE	15	17
SN 150 IB 10	75032	1/2" x 1-1/2" ZINC PLATED STAPLE	10	19
SN 100 B 15	72990	9/16" x 1-1/4" ZINC PLATED STAPLE	15	14
SN 100 IB 15	72611	9/16" x 1-1/4" ZINC PLATED INSULATED STAPLE	15	15
SN 300 B 10	73304	13/16" x 1-3/8" ZINC PLATED STAPLE	10	16
SN 300 IB 10	73306	13/16" x 1-3/8" ZINC PLATED INSULATED STAPLE	10	19
SN 350 B 10	73352	1-1/16" x 1-7/16" ZINC PLATED STAPLE	10	19
SN 350 IB 5	73357	1-1/16" x 1-7/16" ZINC PLATED INSULATED STAPLE	5	14
PS 50 20	72510	1/2" 2-NAIL PLASTIC STAPLE	20	15
PS 75 15	72515	3/4" 2-NAIL PLASTIC STAPLE	15	13
CX 90 20	75053	1/2" x 1" ZINC PLATED COAXIAL STAPLE	20	19
PS 90 B 25	72520	1-NAIL COAXIAL 1/4" BLACK PLASTIC STAPLE	25	9
PS 90 W 25	72521	1-NAIL COAXIAL 1/4" WHITE PLASTIC STAPLE	25	9
PS 80 B 25	72530	3/16" x 1" 1-NAIL BLACK LOW VOLTAGE PLASTIC STAPLE	25	9
PS 80 B 100	72531	3/16" x 1" 1-NAIL BLACK LOW VOLTAGE PLASTIC STAPLE	100	26
PS 80 W 25	72540	3/16" x 1" 1-NAIL WHITE LOW VOLTAGE PLASTIC STAPLE	25	9
PS 80 W 100	72541	3/16" x 1" 1-NAIL WHITE LOW VOLTAGE PLASTIC STAPLE	100	26
#5 BROWN 40 BP	71512	1/4" x 5/8" BROWN LOW VOLTAGE INSULATED STAPLE	40	11
#5 WHITE 40 BP	71516	1/4" x 5/8" WHITE LOW VOLTAGE INSULATED STAPLE	40	11

STAINLESS STEEL CLAMSHELLS

For Use On Pressure Treated Lumber And Exterior Applications

Packaged 100 Clamshells Per Master Case

CATALOG NUMBER	UPC #	DESCRIPTION WIDTH x LENGTH	PARTS PER PACKAGE	MASTER WEIGHT
SN 40 B SS 25	10036	1/2" x 1" STAINLESS STEEL STAPLE	25	15
SN 40 IB SS 20	10031	1/2" x 1" STAINLESS STEEL INSULATED STAPLE	20	15
SN 100 B SS 15	71988	9/16" x 1-1/4" STAINLESS STEEL STAPLE	15	14
SN 100 IB SS 15	72616	9/16" x 1-1/4" STAINLESS STEEL INSULATED STAPLE	15	15
SN 150 B SS 15	75042	1/2" x 1-1/2" STAINLESS STEEL STAPLE	15	17
SN 150 IB SS 10	75033	1/2" x 1-1/2" STAINLESS STEEL INSULATED STAPLE	10	19
SN 300 B SS 10	73309	13/16" x 1-3/8" STAINLESS STEEL STAPLE	10	16
SN 300 IB SS 10	73310	13/16" x 1-3/8" STAINLESS STEEL INSULATED STAPLE	10	19
SN 350 B SS 10	73358	1-1/16" x 1-7/16" STAINLESS STEEL STAPLE	10	19
SN 350 IB SS 5	73355	1-1/16" x 1-7/16" STAINLESS STEEL INSULATED STAPLE	5	14



