

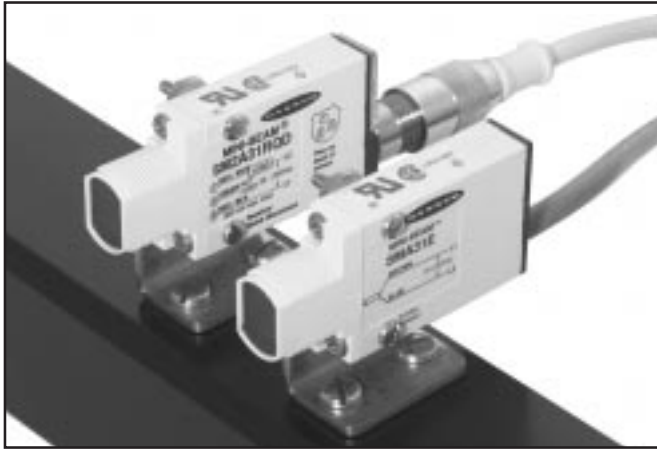

MINI-BEAM® SMA31E/SM2A31R and SMA31EL/SM2A31RL

Self-contained AC-operated Opposed Mode Sensors



- Compact, self-contained opposed mode modulated infrared sensor pairs for 24-240V ac operation
- Standard sensor pairs have 3 m (10 ft) range
- Long range sensor pairs have 30 m (100 ft) range
- Switch-selectable for light operate or dark operate; Highly repeatable, 2 millisecond response "on"/1 millisecond "off" response
- SPST solid state SCR output switches up to 300mA; low leakage current and saturation voltage
- Rugged, epoxy-encapsulated construction: meets NEMA standards 1, 2, 3, 3S, 4, 4X, 12 and 13; IEC IP67
- Physically and electrically interchangeable with 18 mm barrel-type photoelectrics

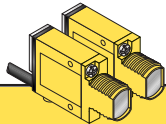
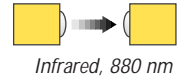

MINI-BEAM Opposed Mode Emitter (E) and Receiver (R)

Models	Range	Cable	Supply Voltage	Output Type	Excess Gain	Beam Pattern
SMA31E SM2A31R SMA31EQD SM2A31RQD	3 m (10 ft)	2 m (6.5 ft) 2 m (6.5 ft) 3-Pin Micro QD 3-Pin Micro QD	24-240V ac	SPST Solid-state 2-Wire		
SMA31EL SM2A31RL SMA31ELQD SM2A31RLQD	30 m (100 ft)	2 m (6.5 ft) 2 m (6.5 ft) 3-Pin Micro QD 3-Pin Micro QD	24-240V ac	SPST Solid-state 2-Wire		

For Standard MINI-BEAMs:

- 9 m (30 ft) cables are available by adding suffix "W/30" to the model number of any cabled sensor (e.g. - SMA31EL W/30).
- A 150 mm (6 in.) long pigtail cable with attached QD connector is available by adding suffix "QDP" to the model number of any MINI-BEAM sensor (e.g. - SMA31ELQDP). See page 5 for more information.
- A model with a QD connector requires an accessory mating cable. See page 8 for more information.

MINI-BEAM Installation and Alignment

Proper operation of the sensors requires that they be mounted securely and aligned properly. Excessive movement or vibration can cause intermittent or false operation due to loss of alignment. For maximum mechanical stability, final-mount these sensors in 18-mm holes by their threaded barrels or use a mounting bracket (see page 6).

- 1) Begin with the emitter mounted securely in place. For small-parts counting applications, stretch a string between the emitter and receiver lenses to ensure that the sensing beam will pass through the center of the sensing location. For less critical applications, the receiver may be initially positioned by line-of-sight placement. Mount the receiver, leaving a means for movement.
- 2) *Set the receiver to light-operate mode.* Apply power to the emitter and receiver, and advance the receiver's 15-turn GAIN control to maximum (clockwise end of rotation). The GAIN control is clutched at both ends to avoid damage, and will "free-wheel" when either end point is reached.

If the receiver is "seeing" the emitter's light beam, the receiver alignment LED should be "on". Move the receiver up-down-right-left (include angular rotation) to locate the center of the movement range within which the LED stays lit. Reducing the GAIN setting will restrict the range of motion and allow precise positioning. NOTE: to aid alignment at short ranges, it may help to further reduce the strength of the light signal by temporarily masking the emitter and/or receiver lens with tape or a sheet of paper.

- 3) Repeat the alignment motions after each GAIN reduction. When you have found the center of the movement range, mount the receiver solidly in that position. Remove any masking material, and increase the receiver GAIN to maximum. Test the system by placing the object to be detected into the sensing position. The receiver LED indicator should go "off". (If it does, alignment is complete, and you may now switch the sensor to dark-operate if the application requires it.) If the LED does *not* go "off", the cause is probably either "flooding" or "burn-through".

Flooding occurs when a portion of the effective beam passes *around* the object to be sensed and activates the receiver. Check that the object completely breaks the beam, and that the beam is centered on the object. Add apertures, if necessary, to tailor the effective beam to the size or profile of the object being sensed. *Burn-through* refers to a portion of the emitter's light energy passing *through* a thin or translucent object and activating the receiver. Try sensing at a reduced GAIN setting or consider an alternative sensing scheme.

Opposed Mode Alignment

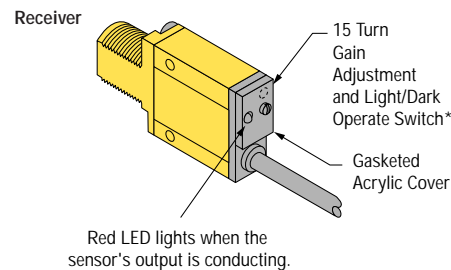
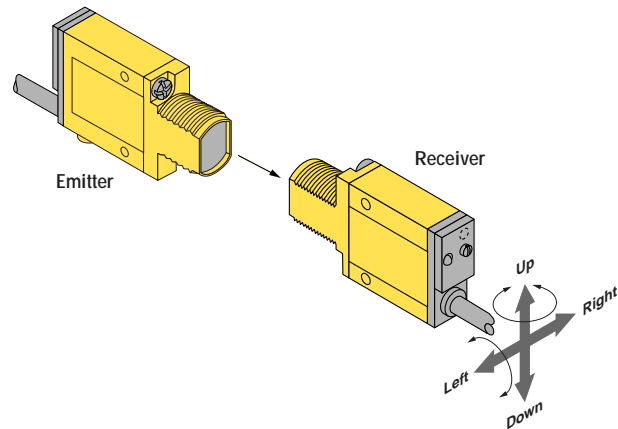

* Note regarding Light/Dark operate switch:

- Turn switch *fully* clockwise for light operate (sensor outputs conduct when object is absent)
- Turn switch *fully* counterclockwise for dark operate (sensor outputs conduct when object is present and blocking light beam)

MINI-BEAM[®] Sensors SMA31E/SM2A31R and SMA31EL/SM2A31RL

MINI-BEAM AC Product Specifications	
Supply Voltage and Current	24 to 240V ac (50/60 Hz), 250V ac max
Supply Protection Circuitry	Protected against transient voltages
Output Configuration	SPST SCR solid-state relay with either normally closed or normally open contact (light/dark operate selectable); 2-wire hookup
Output Rating	Minimum load current 5 mA; maximum steady-state load capability 300 mA to 50°C ambient (122°F) 100 mA to 70°C ambient (158°F) Inrush capability 3 amps for 1 second (non-repetitive); 10 amps for 1 cycle (non-repetitive) Off-state leakage current less than 1.7 mA rms On-state voltage drop ≤5 volts at 300 mA load, ≤10 volts at 15 mA load
Output Protection Circuitry	Protected against false pulse on power-up
Output Response Time	2 millisecond on and 1 millisecond off
Repeatability	0.3 milliseconds
Adjustments	LIGHT/DARK OPERATE select switch, and 15-turn slotted brass screw GAIN (sensitivity) adjustment potentiometer (clutched at both ends of travel). Both controls are located on rear panel of sensor and protected by a gasketed, clear acrylic cover.
Indicators	Red indicator LED on rear of sensor is "ON" when the load is energized
Construction	Reinforced VALOX [®] housing, totally encapsulated, o-ring sealing, acrylic lenses, and stainless steel screws
Environmental Rating	Meets NEMA standards 1, 2, 3, 3S, 4, 4X, 12, and 13; IEC IP67
Connections	PVC-jacketed 2-conductor 2 m (6.5ft) or 9 m (30ft) cables, or 3-pin micro-style quick disconnect (QD) fitting are available. QD cables are ordered separately. See page 8.
Operating Temperature	Temperature: -20° to +70°C (-4° to +158°F) Maximum Relative Humidity: 90% at 50°C (non-condensing)
Application Notes	i) ac MINI-BEAMS may be destroyed from overload conditions ii) Use on low voltage requires careful analysis of the load to determine if the leakage current or on-state voltage of the sensor will interfere with proper operation of the load iii) The false-pulse protection feature may cause momentary drop-out of the load when the sensor is wired in series or parallel with mechanical switch contacts
Certifications	

VALOX[®] is a registered trademark of General Electric Company

MINI-BEAM AC Hookup Diagrams

Receivers with Attached Cable

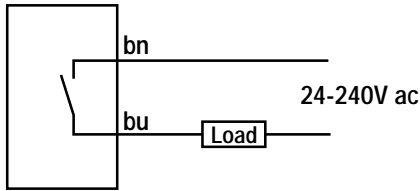

Receivers with Quick Disconnect (3-Pin Micro-Style)

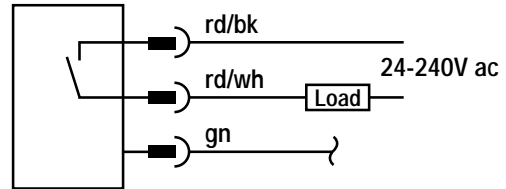

Emitters with Attached Cable

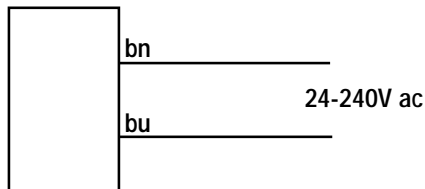

Emitters with Quick Disconnect (3-Pin Micro-Style)

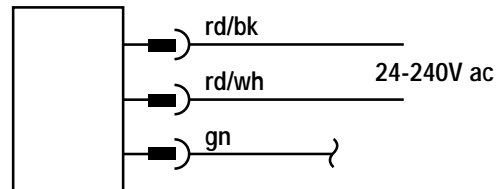

3-Pin Micro-Style Pin-out (Cable Connector Shown)

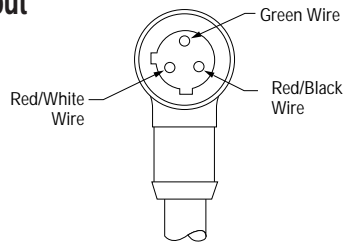

Quick Disconnect (QD) Option

AC MINI-BEAM sensors are sold with either a 2 m (6.5 ft) or a 9 m (30 ft) attached PVC-covered cable, or with a 3-pin micro-style QD cable fitting.

AC QD sensors are identified by the letters "QD" in their model number suffix. For more information on mating QD cables, see page 8.

MINI-BEAM Dimension Information

MINI-BEAM AC Sensor with Integral Cable

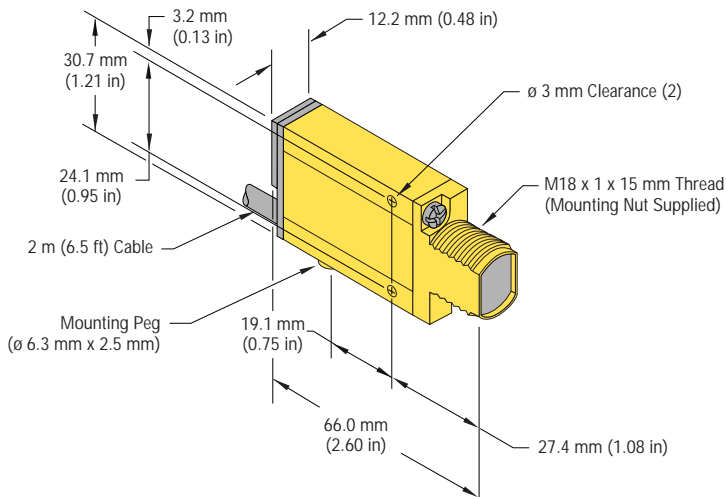

MINI-BEAM AC Sensor with Quick-Disconnect

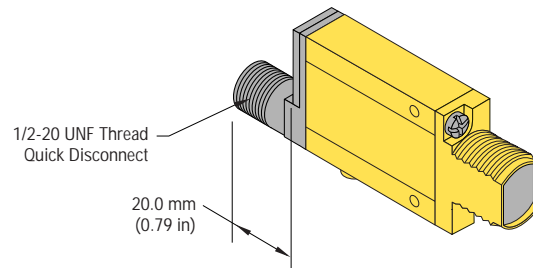

MINI-BEAM® Sensors SMA31E/SM2A31R and SMA31EL/SM2A31RL

MINI-BEAM MODIFICATIONS			
Model Suffix	Modification	Description	Example of Model Number
W/30	9 meter (30 ft) cable	All MINI-BEAM sensors may be ordered with an integral 9 m (30 ft) cable in place of the standard 2 m (6.5 ft) cable	SM2A31R W/30
QDP	Pigtail Quick Disconnect	All MINI-BEAMS may be built with a 150 mm (6 in) long integral cable which is terminated with the appropriate QD connector.	SM2A31RQDP



Apertures			
<p>Opposed mode MINI-BEAM sensors may be fitted with apertures which narrow or shape the effective beam of the sensor to more closely match the size or profile of the object to be sensed. A common example is the use of "line" or "slit" type aperture when wire or thread is sensed. Each model contains 20 apertures.</p>			
Model	Description		
AP31-020 AP31-040 AP31-100	0.5 mm (0.02 in) diameter, circular 1.0 mm (0.04 in) diameter, circular 2.5 mm (0.10 in) diameter, circular		
AP31-020H AP31-040H AP31-100H AP31-200H	0.5 x 6.4 mm (0.02 x 0.25 in), horizontal slotted 1.0 x 6.4 mm (0.04 x 0.25 in), horizontal slotted 2.5 x 6.4 mm (0.10 x 0.25 in), horizontal slotted 5.1 x 6.4 mm (0.20 x 0.25 in), horizontal slotted		
AP31-020V AP31-040V AP31-100V AP31-200V	0.5 x 12.7 mm (0.02 x 0.50 in), vertical slotted 1.0 x 12.7 mm (0.04 x 0.50 in), vertical slotted 2.5 x 12.7 mm (0.10 x 0.50 in), vertical slotted 5.1 x 12.7 mm (0.20 x 0.50 in), vertical slotted		
AP31-DVHX2	Kit containing two of each aperture		

Replacement Lens Assemblies		
MINI-BEAM lens assemblies are field-replaceable.		
Model	Description	
UC-300E	Replacement lens for E/R	
UC-300EL	Replacement lens for EL/RL or use for extending range of E/R	

Right-Angle Reflectors		
MINI-BEAM right-angle reflectors are useful for tight sensing locations. NOTE: These reflectors significantly decrease excess gain.		
Model	Description	
RAR-300SM	<ul style="list-style-type: none"> Side mount reflector Profile dimension of 14 mm (0.56 in) in the direction of the scan 	
RAR-300FM	<ul style="list-style-type: none"> Front mount reflector that attaches directly to the threaded barrel of most MINI-BEAMS Profile dimension of 34 mm (1.35 in) in the direction of the scan 	

MINI-BEAM® Sensors SMA31E/SM2A31R and SMA31EL/SM2A31RL

Mounting Brackets			
Model	Description		
SMB312S	Stainless steel 2-axis, side mounting bracket		
SMB312PD	Stainless steel 18 mm barrel-mounting bracket		
SMB312B	Stainless steel 2-axis, bottom mounting bracket		
SMB46L	<ul style="list-style-type: none"> • "L" bracket • 14 ga 316 stainless steel 		

MINI-BEAM® Sensors SMA31E/SM2A31R and SMA31EL/SM2A31RL

Mounting Brackets			
Model	Description	Dimensions	
SMB46S	<ul style="list-style-type: none"> • “S” bracket • 14 ga 316 stainless steel 		
SMB46U	<ul style="list-style-type: none"> • “U” bracket • 14 ga 316 stainless steel 		
SMB18C	<ul style="list-style-type: none"> • 18 mm split clamp black VALOX® bracket • Stainless steel mounting hardware included 		
SMB18S	<ul style="list-style-type: none"> • 18 mm swivel, black VALOX® bracket • Stainless steel mounting hardware included 		

MINI-BEAM® Sensors SMA31E/SM2A31R and SMA31EL/SM2A31RL

Extension Cables (without connectors)

The following cables are available for extending the length of existing sensor cable. These are 30 m (100 ft) lengths of MINI-BEAM cable. This cable may be spliced to existing cable. Connectors, if used, must be customer-supplied.

Model	Type	Used with:
EC312A-100	2-conductor	All MINI-BEAM ac models

Micro-Style Quick Disconnect Cables

Cable: PVC jacket, polyurethane connector body, nickel-plated brass coupling nut
Conductors: 22 or 20 AWG high-flex stranded, PVC insulation, gold-plated contacts
Temperature: -40 to +80°C (-40 to +176°F)
Voltage Rating: 250V ac/300V dc (3-pin), 125V ac/150V dc (4-pin)



Style	Model	Length	Dimensions	Pin-out
3-Pin Straight	MQDC-306 MQDC-315 MQDC-330	2 m (6.5 ft) 5 m (15 ft) 9 m (30 ft)		
3-Pin Right-angle	MQDC-306RA MQDC-315RA MQDC-330RA	2 m (6.5 ft) 5 m (15 ft) 9 m (30 ft)		

WARRANTY: Banner Engineering Corporation warrants its products to be free from defects for one year. Banner Engineering Corporation will repair or replace, free of charge, any product of its manufacture found to be defective at the time it is returned to the factory during the warranty period. This warranty does not cover damage or liability for the improper application of Banner products. This warranty is in lieu of any other warranty either expressed or implied.



WARNING These photoelectric presence sensors do NOT include the self-checking redundant circuitry necessary to allow their use in personnel safety applications. A sensor failure or malfunction can result in either an energized or a de-energized sensor output condition.

Never use these products as sensing devices for personnel protection. Their use as a safety device may create an unsafe condition which could lead to serious injury or death.

Only MINI-SCREEN®, MULTI-SCREEN®, MICRO-SCREEN™, MACHINE-GUARD™ and PERIMETER-GUARD™ Systems, and other systems so designated, are designed to meet OSHA and ANSI machine safety standards for point-of-operation guarding devices. No other Banner sensors or controls are designed to meet these standards, and they must NOT be used as sensing devices for personnel protection.