

## DESCRIPTION

The Sure-Lites Wet location Emergency Light (SELW) is designed to reduce total egress system cost and maintenance in a wet location environment as well as improve system reliability. Key features include long life LED's, proprietary rotatable accuLED optics, a nickel cadmium battery as well as the Eagle Eye self-diagnostics option. The SELW is UL924 wet location code compliant listed with a standard 0 °C to 40 °C temperature rating or a -20 °C to 55 °C wide temperature option. The SELW's easy hang feature reduces installation time and cost.

Catalog #		Type
Project		
Comments		Date
Prepared by		

## SPECIFICATION FEATURES

### Electrical

- Dual Voltage Input 120/277 VAC, 60Hz
- Brownout circuit
- Low voltage disconnect
- Overload / Short Circuit protection
- 4.8V Battery back-up
- 1.4W AccuLED optics

### Environmental

- Outdoor rated
- SELW: 0 °C to 40 °C (32 °F to 104 °F)
- SELWT: -20 °C to 55 °C (-4 °F to 131 °F)

### Housing Construction

- Components injection molded, color stable, high impact thermoplastic
- White, black, silver, or bronze textured finish
- Snap-fit construction to facilitate fast installation
- Suitable for wall mount applications
- Universal J-box mounting pattern
- Keyhole mounting slots
- Aesthetically designed with a thin profile
- Sealed and gasketed for Wet Location use

### Battery

- Sealed Nickel Cadmium
- Full Recharge Time, 24 hours (max.)

### Warranty

- Five-year warranty

### Code Compliance

- UL924 Wet Location Listed
- Life Safety NFPA 101
- NEC/OSHA
- Most State & Local Codes
- California Energy Code

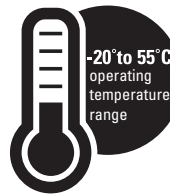
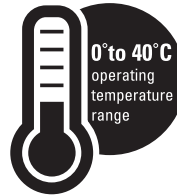
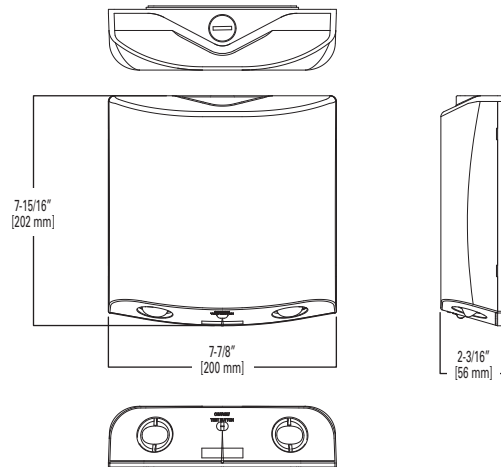

White



Black

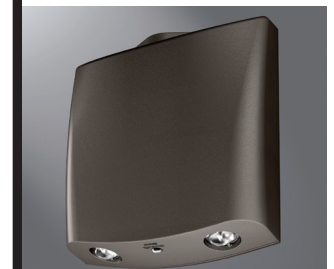

Bronze



Silver

## Emergency Light SELW

LED Emergency Light  
Wet Location  
AccuLED Optic  
Eagle Eye Self Diagnostics

## ORDERING INFORMATION

SAMPLE NUMBER: SELW25BZ

Series	Spacing	Battery	Color	Self Diagnostics	Catalog
SELW=Wet location	25=25 ft.	_ =NC	_ =Silver BZ=Bronze BK=Black WH=White	Not Available	SELW25 SELW25BZ SELW25BK SELW25WH

Series	Spacing	Battery	Color	Self Diagnostics	Catalog
SELW=Wet location	29=29 ft.	_ =NC	_ =Silver BZ=Bronze BK=Black WH=White	SD=self diagnostic	SELW29SD SELW29BZSD SELW29BKSD SELW29WHSD

Series	Spacing	Battery	Color	Self Diagnostics	Catalog
SELWT=Wet location, wide temperature	29=29 ft.	_ =NC	_ =Silver BZ=Bronze BK=Black WH=White	SD=self diagnostic	SELWT29SD SELWT29BZSD SELWT29BKSD SELWT29WHSD

**ELECTRICAL DATA**

Model	120V			277V		
	Power (W)	Current (A)	PF	Power (W)	Current (A)	PF
SELW29SD	0.6	0.07	0.07	0.7	0.07	0.03
SELW25	0.6	0.08	0.064	0.8	0.08	0.03
SELWT29SD	2.0	0.3	0.07	1.8	0.21	0.03

**PHOTOMETRY**

**SELW29SD; SELWT29SD**

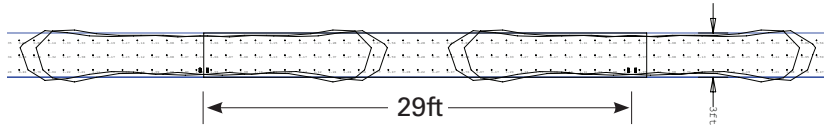

X	Y	Z	Orient	Tilt	Roll
-0.25	0.5	7.5	90	7	1
0.25	0.5	7.5	90	7	-1
28.75	0.5	7.5	90	7	1
29.25	0.5	7.5	90	7	-1
57.75	0.5	7.5	90	7	1
58.25	0.5	7.5	90	7	-1
-29.25	0.5	7.5	90	7	1
-28.75	0.5	7.5	90	7	-1

**SELW25**

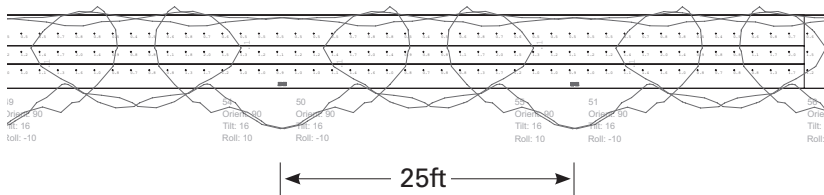

X	Y	Z
0	0.33	7.5
0.33	0.33	7.5
24.33	0.324	7.5
48.33	0.317	7.5
72.33	0.311	7.5
96.33	0.305	7.5
24	0.323	7.5
48	0.316	7.5
72	0.309	7.5
96	0.302	7.5

\*\*\*The "Rule of Thumb" spacing guidelines are designed to achieve 1 foot-candle average and 0.1 foot-candle minimum with a 40:1 maximum/minimum ratio. The corridor used is 100 feet long, 9 foot ceiling with a 6 foot wide walkway and 3 foot path of egress. The reflectances are 80% ceiling, 50% walls and 20% floors. The fixture mounting height is 7.5 feet. Eaton assumes no responsibility for local requirements or specific project variables. This is a guideline to be used as a design aid, not as guarantee of any code compliance.

**TECHNICAL DATA****AccuLED Optics**

The AccuLED precision engineered optics display sharp cutoffs and oval light pattern, which provide a clear path of egress per UL924 standards. The efficient optical design increases spacing distance between units, while providing evenly diffused light pattern throughout the egress path for both 1 foot candle average and 0.1 ft candle minimum. The lens swivel feature within the AccuLED optic provides the opportunity of forward-throw of egress lighting.

**Mechanical Housing**

All components are injection molded with a color stable, high impact thermoplastic resin. The surface is textured to improve aesthetic appearance. The housing construction is designed with snap-fit components and reinforcement ribs to provide maximum strength at minimum installation effort. The mounting hole pattern is universal to junction box requirements and is suitable for wall mount applications.

**EZ Hang – Mounting Feature**

The hands-free EZ Hang feature allows the installer to hang the emergency light face from the back plate in order to easily and efficiently make the power connections.

**Eagle Eye™ Self Diagnostics**

The Eagle Eye self-diagnostic software will automatically perform all tests required by UL924, and NFPA101. The system indicates the status of the emergency light at all times using the LED indicator. A 90 minute battery power (emergency mode) simulation test will occur once every 12 months. A 30 second battery power simulation test will occur every 30 days. The Solid-State microprocessor based system has the ability to accurately detect and warn of system failures, plus it incorporates all of the standard electronic features that sets Sure-Lites apart from its competition. Eagle Eye self diagnostic software automatically performs all testing required by the NFPA 101 Life Safety Code and systematically calibrates itself in the field, reducing installation labor and eliminating manual calibration errors.

**Low Voltage Disconnect**

When the battery's terminal voltage falls, the low-voltage circuitry disconnects the lighting load. The disconnect remains in effect until normal utility power is restored preventing deep battery discharge.

**Brownout Circuit**

The brownout circuit monitors the flow of AC current to the unit and activates the emergency light heads when a predetermined reduction of AC power occurs.

**Warranty**

The SELW series is backed by a five-year warranty on the fixtures and a seven-year pro-rata warranty on the NiCad batteries.

**SELF DIAGNOSTIC TESTING OPERATIONS**

The Sure-Lites Eagle Eye Self Diagnostics is continuously monitoring your emergency fixture, and will signal any failure through the 3 color indicator LED.

**Initial Operation:**

When the unit is first powered up, it will go into a 24 hour fast charge, indicated by the indicator LED pulsing green. Once the unit has fully charged, it will perform a self calibration, after which the LED will change to steady green, indicating the unit is fully charged and float charging the battery to maintain readiness.

**Automatic Testing:**

The unit will perform a battery capacity, lamp/LED, and charge circuit test every 30 days for 30 seconds. During this time, the indicator LED will change to a steady yellow. It will perform a full battery capacity (90 minute) test once per year. During this time, the indicator LED will change to a blinking yellow.

**Manual Testing:**

- 10 Second "Installation" test – Press and release the test button once during fast charge (blinking green) to initiate a 10 second quick test. The sign will switch to emergency mode for 10 seconds allowing the installer to verify proper installation of the unit, and the LED indicator will turn solid yellow
- 30 Second Test - Press and release the test button once during float charge (steady green). The indicator LED will turn steady yellow to indicate the unit is performing a 30 second test of the batteries and lamps/LEDs
- 90 Minute Test - Press and release the test button a second time during a 30 second test (steady yellow) to change to a 90 minute test. During this test, the LED indicator will change to blinking yellow, and the circuit will perform a full battery capacity, charge circuit, and LED test
- Canceling Test – Press and release the test button during the 90 minute test (flashing yellow) to return the fixture to its original state (fast charge or float charge)

**Laser Test:**

The SD versions are equipped with a Laser Test function, that allows the unit to be manually tested without the need to physically press the test button. Shining a laser pointer in the hole marked "LASER TEST" on the bottom of the unit has the same effect as a press and release of the test button.

**Clearing Failure Codes:**

- A battery failure (LED two blink red) can be cleared by replacing the battery. Disconnecting the battery and AC power, or performing a full 90 minute discharge, will reset the error code, however, it will return if the battery is faulty
- Charge Circuit (LED three blink red) and lamp/LED failure (LED four blink red) will clear when the unit successfully passes a manual or

**SELF DIAGNOSTIC TESTING OPERATIONS (CONTINUED)**









automatic 30 second test

**Indicators:**

- LED Off - No power to unit, emergency mode.
- LED Steady Green - Unit is fully charged and is float charging the battery to maintain readiness.
- LED Green Pulse - Unit is in a 24 hour fast charge of the battery.
- LED Two Blink Red - Battery has failed a capacity test, or the battery is disconnected. See "Clearing Failure Codes" above.
- LED Three Blink Red - Battery charge circuit has failed. See "Clearing Failure Codes" above.
- LED Four Blink Red - Lamps have burned out, or on an EXIT/Combo, 50% or more of the LEDs have failed. See "Clearing Failure Codes" above.
- LED Steady Yellow - 30 second test or 10 second quick test (Fast Charge only).
- LED Blinking Yellow - 90 minute test.

**Maintenance:**

None required. Replace the batteries as needed according to ambient conditions. However, we recommend that the equipment be tested regularly in accordance with local codes.

		OFF - EMERGENCY MODE / POWER OFF		STEADY BLINK YELLOW - 90 MINUTE TEST
		STEADY BLINK GREEN - FAST CHARGE		2 BLINK RED - BATTERY FAILURE
		STEADY GREEN - FULL / FLOAT CHARGE		3 BLINK RED - CHARGE CIRCUIT FAILURE
		STEADY YELLOW - QUICK TEST		4 BLINK RED - LAMP/ LED FAILURE

## DESCRIPTION

The Sure-Lites Wet location Emergency Light (SELW) is designed to reduce total egress system cost and maintenance in a wet location environment as well as improve system reliability. Key features include long life LED's, proprietary rotatable accuLED optics, a nickel cadmium battery as well as the Eagle Eye self-diagnostics option. The SELW is UL924 wet location code compliant listed with a standard 0 °C to 40 °C temperature rating or a -20 °C to 55 °C wide temperature option. The SELW's easy hang feature reduces installation time and cost.

Catalog #		Type
Project		
Comments		Date
Prepared by		

## SPECIFICATION FEATURES

### Electrical

- Dual Voltage Input 120/277 VAC, 60Hz
- Brownout circuit
- Low voltage disconnect
- Overload / Short Circuit protection
- 4.8V Battery back-up
- 1.4W AccuLED optics

### Environmental

- Outdoor rated
- SELW: 0 °C to 40 °C (32 °F to 104 °F)
- SELWT: -20 °C to 55 °C (-4 °F to 131 °F)

### Housing Construction

- Components injection molded, color stable, high impact thermoplastic
- White, black, silver, or bronze textured finish
- Snap-fit construction to facilitate fast installation
- Suitable for wall mount applications
- Universal J-box mounting pattern
- Keyhole mounting slots
- Aesthetically designed with a thin profile
- Sealed and gasketed for Wet Location use

### Battery

- Sealed Nickel Cadmium
- Full Recharge Time, 24 hours (max.)

### Warranty

- Five-year warranty

### Code Compliance

- UL924 Wet Location Listed
- Life Safety NFPA 101
- NEC/OSHA
- Most State & Local Codes
- California Energy Code

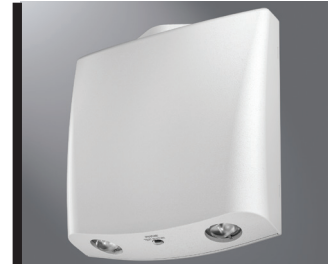
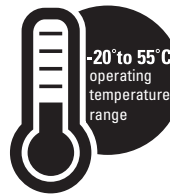
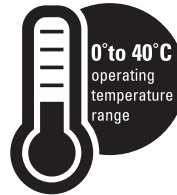
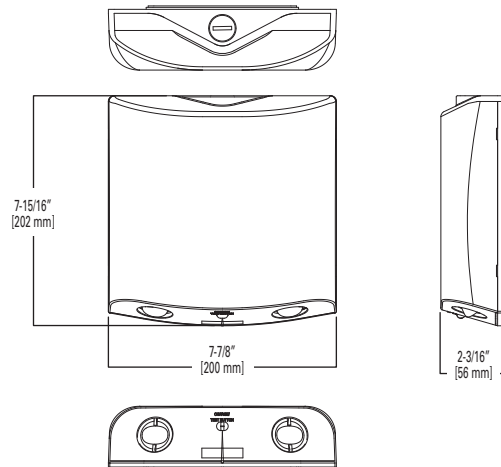

White



Black

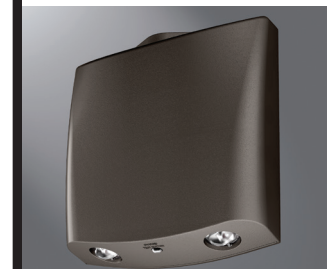

Bronze



Silver

## Emergency Light SELW

LED Emergency Light  
Wet Location  
AccuLED Optic  
Eagle Eye Self Diagnostics

## ORDERING INFORMATION

SAMPLE NUMBER: SELW25BZ

Series	Spacing	Battery	Color	Self Diagnostics	Catalog
SELW=Wet location	25=25 ft.	_ =NC	_ =Silver BZ=Bronze BK=Black WH=White	Not Available	SELW25 SELW25BZ SELW25BK SELW25WH

Series	Spacing	Battery	Color	Self Diagnostics	Catalog
SELW=Wet location	29=29 ft.	_ =NC	_ =Silver BZ=Bronze BK=Black WH=White	SD=self diagnostic	SELW29SD SELW29BZSD SELW29BKSD SELW29WHSD

Series	Spacing	Battery	Color	Self Diagnostics	Catalog
SELWT=Wet location, wide temperature	29=29 ft.	_ =NC	_ =Silver BZ=Bronze BK=Black WH=White	SD=self diagnostic	SELWT29SD SELWT29BZSD SELWT29BKSD SELWT29WHSD

**ELECTRICAL DATA**

Model	120V			277V		
	Power (W)	Current (A)	PF	Power (W)	Current (A)	PF
SELW29SD	0.6	0.07	0.07	0.7	0.07	0.03
SELW25	0.6	0.08	0.064	0.8	0.08	0.03
SELWT29SD	2.0	0.3	0.07	1.8	0.21	0.03

**PHOTOMETRY**

**SELW29SD; SELWT29SD**

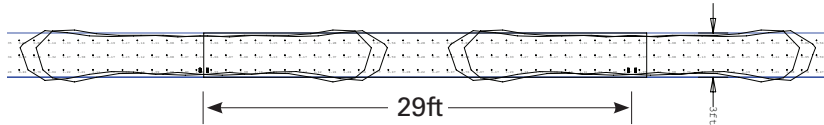

X	Y	Z	Orient	Tilt	Roll
-0.25	0.5	7.5	90	7	1
0.25	0.5	7.5	90	7	-1
28.75	0.5	7.5	90	7	1
29.25	0.5	7.5	90	7	-1
57.75	0.5	7.5	90	7	1
58.25	0.5	7.5	90	7	-1
-29.25	0.5	7.5	90	7	1
-28.75	0.5	7.5	90	7	-1

**SELW25**

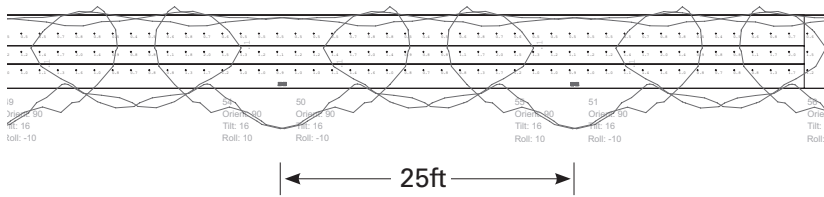

X	Y	Z
0	0.33	7.5
0.33	0.33	7.5
24.33	0.324	7.5
48.33	0.317	7.5
72.33	0.311	7.5
96.33	0.305	7.5
24	0.323	7.5
48	0.316	7.5
72	0.309	7.5
96	0.302	7.5

\*\*\*The "Rule of Thumb" spacing guidelines are designed to achieve 1 foot-candle average and 0.1 foot-candle minimum with a 40:1 maximum/minimum ratio. The corridor used is 100 feet long, 9 foot ceiling with a 6 foot wide walkway and 3 foot path of egress. The reflectances are 80% ceiling, 50% walls and 20% floors. The fixture mounting height is 7.5 feet. Eaton assumes no responsibility for local requirements or specific project variables. This is a guideline to be used as a design aid, not as guarantee of any code compliance.

**TECHNICAL DATA****AccuLED Optics**

The AccuLED precision engineered optics display sharp cutoffs and oval light pattern, which provide a clear path of egress per UL924 standards. The efficient optical design increases spacing distance between units, while providing evenly diffused light pattern throughout the egress path for both 1 foot candle average and 0.1 ft candle minimum. The lens swivel feature within the AccuLED optic provides the opportunity of forward-throw of egress lighting.

**Mechanical Housing**

All components are injection molded with a color stable, high impact thermoplastic resin. The surface is textured to improve aesthetic appearance. The housing construction is designed with snap-fit components and reinforcement ribs to provide maximum strength at minimum installation effort. The mounting hole pattern is universal to junction box requirements and is suitable for wall mount applications.

**EZ Hang – Mounting Feature**

The hands-free EZ Hang feature allows the installer to hang the emergency light face from the back plate in order to easily and efficiently make the power connections.

**Eagle Eye™ Self Diagnostics**

The Eagle Eye self-diagnostic software will automatically perform all tests required by UL924, and NFPA101. The system indicates the status of the emergency light at all times using the LED indicator. A 90 minute battery power (emergency mode) simulation test will occur once every 12 months. A 30 second battery power simulation test will occur every 30 days. The Solid-State microprocessor based system has the ability to accurately detect and warn of system failures, plus it incorporates all of the standard electronic features that sets Sure-Lites apart from its competition. Eagle Eye self diagnostic software automatically performs all testing required by the NFPA 101 Life Safety Code and systematically calibrates itself in the field, reducing installation labor and eliminating manual calibration errors.

**Low Voltage Disconnect**

When the battery's terminal voltage falls, the low-voltage circuitry disconnects the lighting load. The disconnect remains in effect until normal utility power is restored preventing deep battery discharge.

**Brownout Circuit**

The brownout circuit monitors the flow of AC current to the unit and activates the emergency light heads when a predetermined reduction of AC power occurs.

**Warranty**

The SELW series is backed by a five-year warranty on the fixtures and a seven-year pro-rata warranty on the NiCad batteries.

**SELF DIAGNOSTIC TESTING OPERATIONS**

The Sure-Lites Eagle Eye Self Diagnostics is continuously monitoring your emergency fixture, and will signal any failure through the 3 color indicator LED.

**Initial Operation:**

When the unit is first powered up, it will go into a 24 hour fast charge, indicated by the indicator LED pulsing green. Once the unit has fully charged, it will perform a self calibration, after which the LED will change to steady green, indicating the unit is fully charged and float charging the battery to maintain readiness.

**Automatic Testing:**

The unit will perform a battery capacity, lamp/LED, and charge circuit test every 30 days for 30 seconds. During this time, the indicator LED will change to a steady yellow. It will perform a full battery capacity (90 minute) test once per year. During this time, the indicator LED will change to a blinking yellow.

**Manual Testing:**

- 10 Second "Installation" test – Press and release the test button once during fast charge (blinking green) to initiate a 10 second quick test. The sign will switch to emergency mode for 10 seconds allowing the installer to verify proper installation of the unit, and the LED indicator will turn solid yellow
- 30 Second Test - Press and release the test button once during float charge (steady green). The indicator LED will turn steady yellow to indicate the unit is performing a 30 second test of the batteries and lamps/LEDs
- 90 Minute Test - Press and release the test button a second time during a 30 second test (steady yellow) to change to a 90 minute test. During this test, the LED indicator will change to blinking yellow, and the circuit will perform a full battery capacity, charge circuit, and LED test
- Canceling Test – Press and release the test button during the 90 minute test (flashing yellow) to return the fixture to its original state (fast charge or float charge)

**Laser Test:**

The SD versions are equipped with a Laser Test function, that allows the unit to be manually tested without the need to physically press the test button. Shining a laser pointer in the hole marked "LASER TEST" on the bottom of the unit has the same effect as a press and release of the test button.

**Clearing Failure Codes:**

- A battery failure (LED two blink red) can be cleared by replacing the battery. Disconnecting the battery and AC power, or performing a full 90 minute discharge, will reset the error code, however, it will return if the battery is faulty
- Charge Circuit (LED three blink red) and lamp/LED failure (LED four blink red) will clear when the unit successfully passes a manual or



**SELF DIAGNOSTIC TESTING OPERATIONS (CONTINUED)**









automatic 30 second test

**Indicators:**

- LED Off - No power to unit, emergency mode.
- LED Steady Green - Unit is fully charged and is float charging the battery to maintain readiness.
- LED Green Pulse - Unit is in a 24 hour fast charge of the battery.
- LED Two Blink Red - Battery has failed a capacity test, or the battery is disconnected. See "Clearing Failure Codes" above.
- LED Three Blink Red - Battery charge circuit has failed. See "Clearing Failure Codes" above.
- LED Four Blink Red - Lamps have burned out, or on an EXIT/Combo, 50% or more of the LEDs have failed. See "Clearing Failure Codes" above.
- LED Steady Yellow - 30 second test or 10 second quick test (Fast Charge only).
- LED Blinking Yellow - 90 minute test.

**Maintenance:**

None required. Replace the batteries as needed according to ambient conditions. However, we recommend that the equipment be tested regularly in accordance with local codes.

		OFF - EMERGENCY MODE / POWER OFF		STEADY BLINK YELLOW - 90 MINUTE TEST
		STEADY BLINK GREEN - FAST CHARGE		2 BLINK RED - BATTERY FAILURE
		STEADY GREEN - FULL / FLOAT CHARGE		3 BLINK RED - CHARGE CIRCUIT FAILURE
		STEADY YELLOW - QUICK TEST		4 BLINK RED - LAMP/ LED FAILURE