

DESCRIPTION

The Halo RA4 LED Adjustable Gimbal series are retrofit LED Modules for 4" aperture recessed downlights. The RA4 gimbals feature adjustment of 35-degree tilt and up to 360-degree rotation. In addition the RA4 gimbals offer selection of narrow flood (NFL) and very wide flood (VWFL) models for beam distributions suitable for accent, task, grazing and general area lighting. The RA4 integral LED 120V driver is dimmable with most leading edge and trailing edge phase control dimmers.

Catalog #		Type
Project		
Comments		Date
Prepared by		

SPECIFICATION FEATURES

MECHANICAL

- Module includes LED, heat sink, reflector, lens optic, baffle reveal, and trim ring
- Durable die-cast aluminum construction
- Integrated heat sink design conducts heat away from the LED keeping the junction temperatures below specified maximums, even when installed in insulated ceiling environments
- Halo matte white paint finish
- 35-degree tilt
- Up to 360-degree rotation

Optics

NARROW FLOOD - NFL

- Precision acrylic lens
- Optical design creates a clean, uniform 25-degree beam distribution

VERY WIDE FLOOD - VWFL

- Impact-resistant polycarbonate
- Convex form for lamp-like appearance
- Diffusing, wide beam for even illumination

MOUNTING

Friction Blades

- Precision formed spring blades secure module with friction fit to compatible housings.
- Friction blade design allows the RA4 to be installed in any position within the housing aperture (360 degrees)

Housing Compatibility

See Housing Compatibility

LED

- Color Temperature (CCT)
Options: 2700K, 3000K
- Color Rendering Index (CRI) 90
- LED is a chip on board design consisting of a multiple LED package with proximity phosphor coating to create one virtual white light source for a productive "cone of light"

ELECTRICAL

Power Connections

- LED connector is a non-screw base luminaire disconnect offering easy installation with the matching Halo H995 and H245 Series housings.
- LED Connector meets high-efficacy luminaire requirements for a non-screw base socket, and where required to qualify as a high-efficacy luminaire. (California Title-24)
- The included E26 medium screw-base Edison adapter provides easy retrofit of incandescent housings (see Housing Compatibility)*

Ground Connection

- Separate grounding cable included on the module for attachment to the housing during installation.

LED Driver

- Dimmable driver is a 120 Volt, high efficiency, electronic power supply providing DC power to the LED.
- Driver meets FCC EMI/RFI Consumer Level limits for use in residential and commercial installations.
- Driver features high power factor, low THD, and has integral thermal protection in the event of over temperature or internal failure.
- Driver mounts externally to the module, allowing future replacement, if needed.

Dimming

- Designed for continuous dimming capability to nominally 5% with many 120V Leading Edge (LE) and Trailing Edge (TE) phase control dimmers. Dimming to 5% is best assured using dimmers with low end trim adjustment. Consult dimmer manufacturer for compatibility and conditions of use. (Note some dimmers require a neutral in the wallbox.)

Warranty

Eaton provides a five year limited warranty on RA56 LED.

Compliance Labels

- UL/cUL Listed 1598 Luminaire (with listed Halo housings)
- UL Classified (with other housings - see Housing Compatibility)
- UL/cUL Listed for Damp Location
- May be installed in housings in direct contact with air permeable insulation** and combustible material
- IP ingress protection rating
NFL models: IP25
VWFL models: IP34

Qualification

- ENERGY STAR® qualified residential and commercial*
- Can be used for State of California Title 24 high efficacy luminaire compliance*
- Can be used for International Energy Conservation Code (IECC) high efficacy luminaire Compliance

IC (Insulated Ceiling)

Listed UL/cUL 1598 with compatible housings, may be used to meet insulated ceiling** requirements such as:

- International Energy Conservation Code (IECC)
- New York State Energy Conservation Construction Code (NY-ECCC)
- State of California Title 24 "Recessed Luminaires in Insulated Ceilings."



**RA4 LED
Very Wide Flood
(VWFL)**



**RA4 LED
Narrow Flood
(NFL)**

**4-Inch
Adjustable Gimbals
All-Purpose Recessed
Retrofit Modules**

**FOR USE IN INSULATED
CEILING AND NON-
INSULATED
CEILING RATED HOUSINGS**

**HIGH EFFICACY LED
WITH INTEGRAL DRIVER -
DIMMABLE**

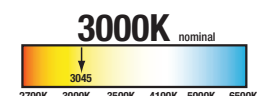
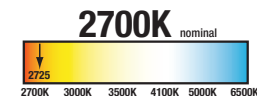

Refer to ENERGY STAR® Qualified Products List. Can be used to comply with California Title 24 High Efficacy requirements. Certified to California Appliance Efficiency Database under JAB. Indoor LED nominal CCT of 4000K or less.

*Qualified and compliant. Refer to ENERGY STAR® Qualified Products List and CEC (T24) Appliance Database for listings.

** Not for use with housings in direct contact with spray foam insulation.

*Non-California Product Only

ENERGY DATA

Minimum Starting Temp: -30°C (-22°F)
EM/RFI: FCC Title 47 CFR, Part 15, Class B (Consumer)
Sound Rating: Class A standards
Input Voltage: 120V
Power Factor: >0.90
Input Frequency: 50/60Hz
THD: <20%
Input Power: 10W
Input Current: 85mA

Driver-Safety Agency Approvals:

- UL60950-1 Recognized
- LPS output
- UL8750 Compliant

Maximum IC (Insulated Ceiling) Ambient Continuous Operating Temperature: 25°C (77°F)

Maximum Non-IC (NON-Insulated Ceiling) Ambient Continuous Operating Temperature 40°C (104°F)

DIMENSIONS

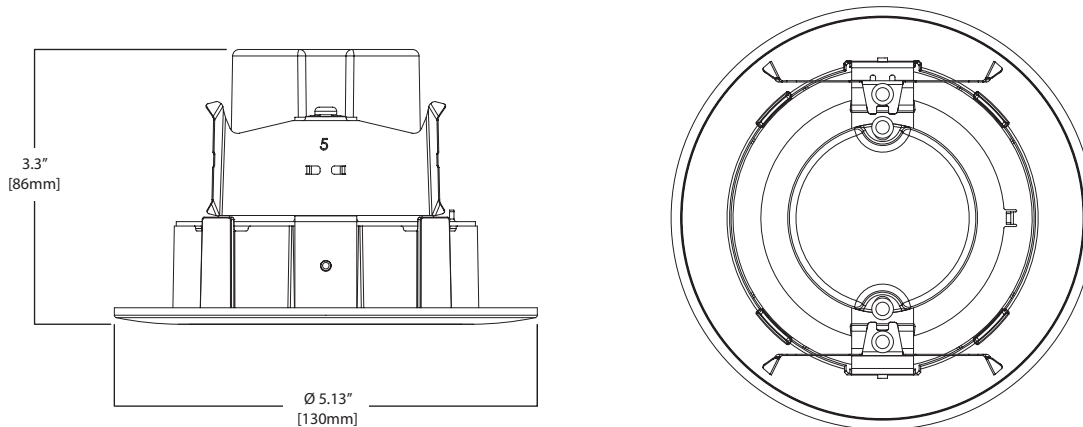

LIGHTING FACTS

RA406927WH
2700K Source
VWFL Beam

RA406930WH
3000K Source
VWFL Beam

RA406927NFLWH
2700K Source
NFL Beam

RA406930NFLWH
3000K Source
NFL Beam

Lighting facts
A Program of the U.S. DOE

Light Output (Lumens)	600
Watts	10
Lumens per Watt (Efficacy)	60
Color Accuracy Color Rendering Index (CRI)	90
Light Color Correlated Color Temperature (CCT)	2700 (Warm White)

Warm White 2700K 3000K Bright White 4500K Daylight 6500K

All results are according to IESNA LM-79-2008. Approved Method for the Electrical and Photometric Testing of Solid-State Lighting. The U.S. Department of Energy (DOE) verifies product test data and results.

Visit www.lightingfacts.com for the Label Reference Guide.

Registration Number: F4QJMA646H (10/25/2013)
Model Number: RA406927WH
Type: Retrofit Kit - Downlight

Lighting facts
A Program of the U.S. DOE

Light Output (Lumens)	615
Watts	10
Lumens per Watt (Efficacy)	61
Color Accuracy Color Rendering Index (CRI)	90
Light Color Correlated Color Temperature (CCT)	3000 (Bright White)

Warm White 2700K 3000K Bright White 4500K Daylight 6500K

All results are according to IESNA LM-79-2008. Approved Method for the Electrical and Photometric Testing of Solid-State Lighting. The U.S. Department of Energy (DOE) verifies product test data and results.

Visit www.lightingfacts.com for the Label Reference Guide.

Registration Number: F4QJ15CJ0B (10/25/2013)
Model Number: RA406930WH
Type: Retrofit Kit - Downlight

Lighting facts
A Program of the U.S. DOE

Light Output (Lumens)	640
Watts	10
Lumens per Watt (Efficacy)	64
Color Accuracy Color Rendering Index (CRI)	90
Light Color Correlated Color Temperature (CCT)	2700 (Warm White)

Warm White 2700K 3000K Bright White 4500K Daylight 6500K

All results are according to IESNA LM-79-2008. Approved Method for the Electrical and Photometric Testing of Solid-State Lighting. The U.S. Department of Energy (DOE) verifies product test data and results.

Visit www.lightingfacts.com for the Label Reference Guide.

Registration Number: F4QJ-OTFN0L (10/25/2013)
Model Number: RA406927NFLWH
Type: Retrofit Kit - Downlight

Lighting facts
A Program of the U.S. DOE

Light Output (Lumens)	640
Watts	10
Lumens per Watt (Efficacy)	64
Color Accuracy Color Rendering Index (CRI)	90
Light Color Correlated Color Temperature (CCT)	3000 (Bright White)

Warm White 2700K 3000K Bright White 4500K Daylight 6500K

All results are according to IESNA LM-79-2008. Approved Method for the Electrical and Photometric Testing of Solid-State Lighting. The U.S. Department of Energy (DOE) verifies product test data and results.

Visit www.lightingfacts.com for the Label Reference Guide.

Registration Number: F4QJ4ID24Z (10/25/2013)
Model Number: RA406930NFLWH
Type: Retrofit Kit - Downlight

For further information refer to the Lighting Facts website at <http://lightingfacts.com/>.

ORDERING INFORMATION

SAMPLE NUMBER: RA406930WH

Complete unit includes RA4 LED and a compatible 4" housing; ordered separately.

RA4 Series	Accessory (order separately)
<p>Very Wide Flood - VWFL Models RA406927WH= 4" LED Adjustable Gimbal, 90CRI, 2700K, White, Very Wide Flood RA406930WH= 4" LED Adjustable Gimbal, 90CRI, 3000K, White, Very Wide Flood</p> <p>Narrow Flood - NFL Models RA406927NFLWH= 4" LED Adjustable Gimbal, 90CRI, 2700K, White, Narrow Flood RA406930NFLWH= 4" LED Adjustable Gimbal, 90CRI, 3000K, White, Narrow Flood</p> <p>California non-E26 Models SLD405927WH-CA SLD405930WH-CA SSLD405935WH-CA SSLD405940WH-CA</p>	<p>HE26LED=Replacement screw base adapter (one included with unit)</p>

Housing
<p>H995ICAT= 4" LED Insulated Ceiling, AIR-TITE New Construction Housing with LED luminaire connector (high efficacy compliant) H995RICAT= 4" LED Insulated Ceiling, AIR-TITE Remodel Housing with LED luminaire connector (high efficacy compliant)</p>

HOUSING COMPATIBILITY

The RA4 is UL Listed in Halo and All-Pro recessed housings, and is UL Classified for use with any 4 inch diameter recessed housing constructed of steel or aluminum with an internal volume that exceeds 62.3 in³ in addition to those noted below:

Compatible Halo LED Housings with LED luminaire connector (high-efficacy compliant)		
HALO LED	Recessed Can Size	Catalog Number
		4"
Compatible Halo Incandescent E26 Screwbase Housings		
HALO	Recessed Can Size	Catalog Number
		4"

PHOTOMETRY

RA406927WH
 Reflector Beam Angle = VWFL Beam
 (Very Wide Flood)
 CCT = 2700K
 Spacing Criteria = 1.18
 Lumens per Watt = 60 Lm/W
 Test No. P121906
 Test Model: RA406927WH

Cone of Light Footcandles 0 deg Aiming Angle Horizontal Illuminance on Floor				
Distance to Illuminated Plane	Initial Nadir Footcandles	Beam (ft.)		
		L Length	W Width	
5.5'	9.7	6.4	6.4	
7'	6	8.2	8.2	
8'	4.6	9.4	9.4	
9'	3.6	10.6	10.6	
10'	2.9	11.8	11.8	

Cone of Light Footcandles 35 deg Aiming Angle Vertical Illuminance on Wall				
Distance to Illuminated Plane	Initial Nadir Footcandles	Beam (ft.)		CB
		L Length	W Width	
2'	43.5	2.1	2.4	2.9
3'	19.3	3.2	3.6	4.3
4'	10.9	4.2	4.8	5.7
5'	7	5.3	6	7.1
6'	4.8	6.4	7.4	8.6
8'	2.7	8.6	9.8	11.4
10'	1.7	10.8	12.2	14.3

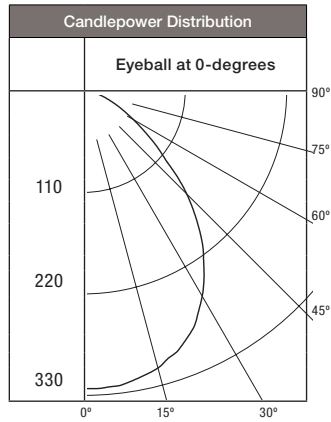

Candela Distribution	
Degrees Vertical	Candela
0*	293
5	293
15	283
25	257
35	206
45	144
55	79
65	40
75	18
85	6
90	0

Luminance (Average Candela/M ²)	
Degree	Avg. 0° Luminance
45	43944
55	29652
65	20532
75	15132
85	14648

Zonal Lumen Summary		
Zone	Lumens	% Fixture
0-30	225	37.4
0-40	354	58.9
0-60	534	89.0
0-90	600	100

*CBCP

RA406930WH
 Reflector Beam Angle = VWFL Beam
 (Very Wide Flood)
 CCT = 3000K
 Spacing Criteria = 1.18
 Lumens per Watt = 61.5 Lm/W
 Test No. P121908
 Test Model: RA406930WH

Cone of Light Footcandles 0 deg Aiming Angle Horizontal Illuminance on Floor				
Distance to Illuminated Plane	Initial Nadir Footcandles	Beam (ft.)		
		L Length	W Width	
5.5'	9.9	6.4	6.4	
7'	6.1	8.2	8.2	
8'	4.7	9.4	9.4	
9'	3.7	10.6	10.6	
10'	3	11.8	11.8	

Cone of Light Footcandles 35 deg Aiming Angle Vertical Illuminance on Wall				
Distance to Illuminated Plane	Initial Nadir Footcandles	Beam (ft.)		CB
		L Length	W Width	
2'	44.6	2.1	2.4	2.9
3'	19.8	3.2	3.6	4.3
4'	11.1	4.2	4.8	5.7
5'	7.1	5.3	6	7.1
6'	5	6.4	7.4	8.6
8'	2.8	8.6	9.8	11.4
10'	1.8	10.8	12.2	14.3

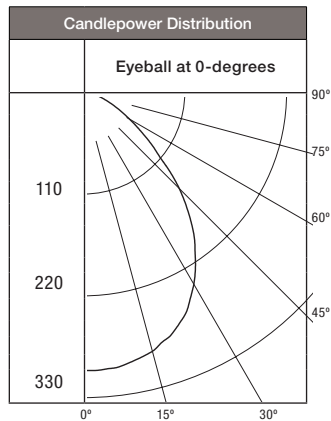

Candela Distribution	
Degrees Vertical	Candela
0*	301
5	300
15	290
25	263
35	211
45	147
55	81
65	41
75	19
85	6
90	0

Luminance (Average Candela/M ²)	
Degree	Avg. 0° Luminance
45	45015
55	30407
65	21044
75	15551
85	14896

Zonal Lumen Summary		
Zone	Lumens	% Fixture
0-30	230	37.4
0-40	362	58.9
0-60	548	89.0
0-90	615	100

*CBCP

PHOTOMETRY

RA406927NFLWH
 Reflector Beam Angle = NFL Beam (Narrow Flood)
 CCT = 2700K
 Spacing Criteria = 0.35
 Lumens per Watt = 64 Lm/W
 Test No. P121904
 Test Model: RA406927NFLWH

Cone of Light Footcandles 0 deg Aiming Angle Horizontal Illuminance on Floor			
Distance to Illuminated Plane	Initial Nadir Footcandles	Beam (ft.)	
		L Length	W Width
5.5'	98.7	1.8	1.8
7'	60.9	2.4	2.4
8'	46.6	2.8	2.8
9'	36.9	3	3
10'	29.9	3.4	3.4

Cone of Light Footcandles 35 deg Aiming Angle Vertical Illuminance on Wall				
Distance to Illuminated Plane	Initial Nadir Footcandles	Beam (ft.)		
		L Length	W Width	CB
2'	168	1.7	1	2.9
3'	74.7	2.6	1.6	4.3
4'	42	3.5	2.2	5.7
5'	26.9	4.4	2.8	7.1
6'	18.7	5.3	3.4	8.6
8'	10.5	7.1	4.4	11.4
10'	6.7	8.9	5.6	14.3

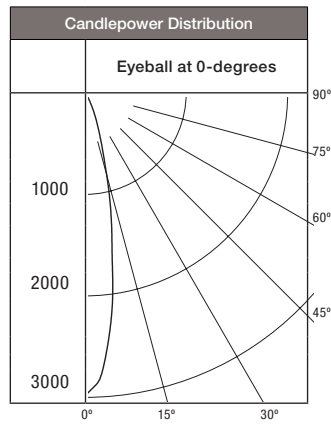

Candela Distribution	
Degrees Vertical	Candela
0*	2985
5	2531
15	836
25	223
35	62
45	27
55	14
65	6
75	2
85	0
90	0

Luminance (Average Candela/M ²)	
Degree	Avg. 0° Luminance
45	6559
55	3723
65	1726
75	577
85	168

Zonal Lumen Summary		
Zone	Lumens	% Fixture
0-30	556	86.9
0-40	598	93.4
0-60	631	98.7
0-90	640	100

*CBCP

RA406930NFLWH
 Reflector Beam Angle = NFL Beam (Narrow Flood)
 CCT = 3000K
 Spacing Criteria = 0.35
 Lumens per Watt = 64 Lm/W
 Test No. P121905
 Test Model: RA406930NFLWH

Cone of Light Footcandles 0 deg Aiming Angle Horizontal Illuminance on Floor			
Distance to Illuminated Plane	Initial Nadir Footcandles	Beam (ft.)	
		L Length	W Width
5.5'	98.7	1.8	1.8
7'	60.9	2.4	2.4
8'	46.6	2.8	2.8
9'	36.9	3	3
10'	29.9	3.4	3.4

Cone of Light Footcandles 35 deg Aiming Angle Vertical Illuminance on Wall				
Distance to Illuminated Plane	Initial Nadir Footcandles	Beam (ft.)		
		L Length	W Width	CB
2'	168	1.7	1	2.9
3'	74.7	2.6	1.6	4.3
4'	42	3.5	2.2	5.7
5'	26.9	4.4	2.8	7.1
6'	18.7	5.3	3.4	8.6
8'	10.5	7.1	4.4	11.4
10'	6.7	8.9	5.6	14.3

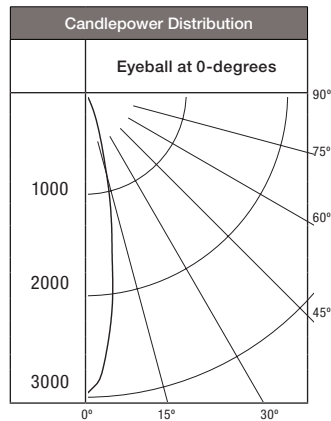

Candela Distribution	
Degrees Vertical	Candela
0*	2985
5	2531
15	836
25	223
35	62
45	27
55	14
65	6
75	2
85	0
90	0

Luminance (Average Candela/M ²)	
Degree	Avg. 0° Luminance
45	6559
55	3723
65	1726
75	577
85	168

Zonal Lumen Summary		
Zone	Lumens	% Fixture
0-30	556	86.9
0-40	598	93.4
0-60	631	98.7
0-90	640	100

*CBCP

DESCRIPTION

The Halo RA4 LED Adjustable Gimbal series are retrofit LED Modules for 4" aperture recessed downlights. The RA4 gimbals feature adjustment of 35-degree tilt and up to 360-degree rotation. In addition the RA4 gimbals offer selection of narrow flood (NFL) and very wide flood (VWFL) models for beam distributions suitable for accent, task, grazing and general area lighting. The RA4 integral LED 120V driver is dimmable with most leading edge and trailing edge phase control dimmers.

Catalog #		Type
Project		
Comments		Date
Prepared by		

SPECIFICATION FEATURES

MECHANICAL

- Module includes LED, heat sink, reflector, lens optic, baffle reveal, and trim ring
- Durable die-cast aluminum construction
- Integrated heat sink design conducts heat away from the LED keeping the junction temperatures below specified maximums, even when installed in insulated ceiling environments
- Halo matte white paint finish
- 35-degree tilt
- Up to 360-degree rotation

Optics

NARROW FLOOD - NFL

- Precision acrylic lens
- Optical design creates a clean, uniform 25-degree beam distribution

VERY WIDE FLOOD - VWFL

- Impact-resistant polycarbonate
- Convex form for lamp-like appearance
- Diffusing, wide beam for even illumination

MOUNTING

Friction Blades

- Precision formed spring blades secure module with friction fit to compatible housings.
- Friction blade design allows the RA4 to be installed in any position within the housing aperture (360 degrees)

Housing Compatibility

See Housing Compatibility

LED

- Color Temperature (CCT)
Options: 2700K, 3000K
- Color Rendering Index (CRI) 90
- LED is a chip on board design consisting of a multiple LED package with proximity phosphor coating to create one virtual white light source for a productive "cone of light"

ELECTRICAL

Power Connections

- LED connector is a non-screw base luminaire disconnect offering easy installation with the matching Halo H995 and H245 Series housings.
- LED Connector meets high-efficacy luminaire requirements for a non-screw base socket, and where required to qualify as a high-efficacy luminaire. (California Title-24)
- The included E26 medium screw-base Edison adapter provides easy retrofit of incandescent housings (see Housing Compatibility)*

Ground Connection

- Separate grounding cable included on the module for attachment to the housing during installation.

LED Driver

- Dimmable driver is a 120 Volt, high efficiency, electronic power supply providing DC power to the LED.
- Driver meets FCC EMI/RFI Consumer Level limits for use in residential and commercial installations.
- Driver features high power factor, low THD, and has integral thermal protection in the event of over temperature or internal failure.
- Driver mounts externally to the module, allowing future replacement, if needed.

Dimming

- Designed for continuous dimming capability to nominally 5% with many 120V Leading Edge (LE) and Trailing Edge (TE) phase control dimmers. Dimming to 5% is best assured using dimmers with low end trim adjustment. Consult dimmer manufacturer for compatibility and conditions of use. (Note some dimmers require a neutral in the wallbox.)

Warranty

Eaton provides a five year limited warranty on RA56 LED.

Compliance Labels

- UL/cUL Listed 1598 Luminaire (with listed Halo housings)
- UL Classified (with other housings - see Housing Compatibility)
- UL/cUL Listed for Damp Location
- May be installed in housings in direct contact with air permeable insulation** and combustible material
- IP ingress protection rating
NFL models: IP25
VWFL models: IP34

Qualification

- ENERGY STAR® qualified residential and commercial*
- Can be used for State of California Title 24 high efficacy luminaire compliance*
- Can be used for International Energy Conservation Code (IECC) high efficacy luminaire Compliance

IC (Insulated Ceiling)

Listed UL/cUL 1598 with compatible housings, may be used to meet insulated ceiling** requirements such as:

- International Energy Conservation Code (IECC)
- New York State Energy Conservation Construction Code (NY-ECCC)
- State of California Title 24 "Recessed Luminaires in Insulated Ceilings."



**RA4 LED
Very Wide Flood
(VWFL)**



**RA4 LED
Narrow Flood
(NFL)**

**4-Inch
Adjustable Gimbals
All-Purpose Recessed
Retrofit Modules**

**FOR USE IN INSULATED
CEILING AND NON-
INSULATED
CEILING RATED HOUSINGS**

**HIGH EFFICACY LED
WITH INTEGRAL DRIVER -
DIMMABLE**

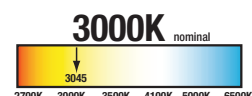
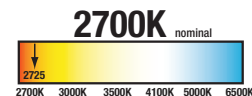

Refer to ENERGY STAR® Qualified Products List. Can be used to comply with California Title 24 High Efficacy requirements. Certified to California Appliance Efficiency Database under JAB. Indoor LED nominal CCT of 4000K or less.

*Qualified and compliant. Refer to ENERGY STAR® Qualified Products List and CEC (T24) Appliance Database for listings.

** Not for use with housings in direct contact with spray foam insulation.

*Non-California Product Only

ENERGY DATA

Minimum Starting Temp: -30°C (-22°F)
EM/RFI: FCC Title 47 CFR, Part 15, Class B (Consumer)
Sound Rating: Class A standards
Input Voltage: 120V
Power Factor: >0.90
Input Frequency: 50/60Hz
THD: <20%
Input Power: 10W
Input Current: 85mA

Driver-Safety Agency Approvals:

- UL60950-1 Recognized
- LPS output
- UL8750 Compliant

Maximum IC (Insulated Ceiling) Ambient Continuous Operating Temperature: 25°C (77°F)

Maximum Non-IC (NON-Insulated Ceiling) Ambient Continuous Operating Temperature 40°C (104°F)

DIMENSIONS

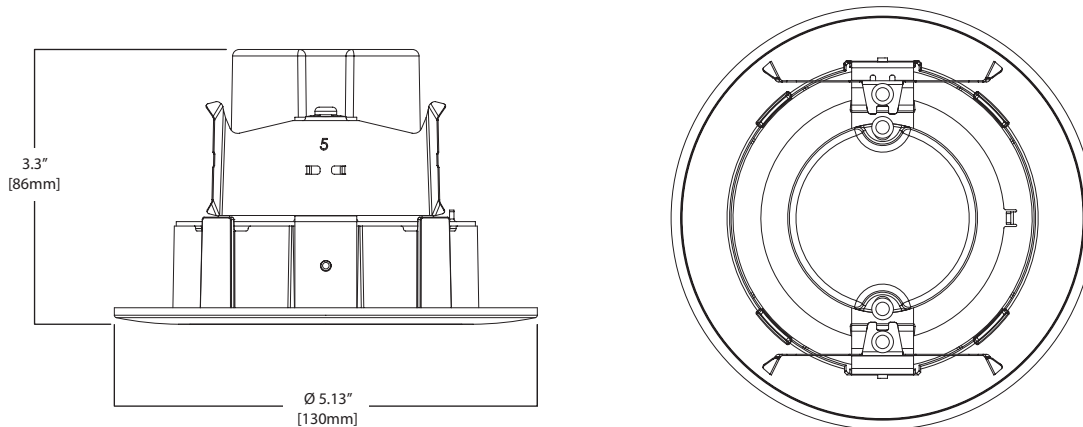

LIGHTING FACTS

RA406927WH
2700K Source
VWFL Beam

RA406930WH
3000K Source
VWFL Beam

RA406927NFLWH
2700K Source
NFL Beam

RA406930NFLWH
3000K Source
NFL Beam

Lighting facts
A Program of the U.S. DOE

Light Output (Lumens)	600
Watts	10
Lumens per Watt (Efficacy)	60
Color Accuracy Color Rendering Index (CRI)	90
Light Color Correlated Color Temperature (CCT)	2700 (Warm White)

Warm White 2700K 3000K Bright White 4500K Daylight 6500K

All results are according to IESNA LM-79-2008. Approved Method for the Electrical and Photometric Testing of Solid-State Lighting. The U.S. Department of Energy (DOE) verifies product test data and results.

Visit www.lightingfacts.com for the Label Reference Guide.

Registration Number: F4QJMA646H (10/25/2013)
Model Number: RA406927WH
Type: Retrofit Kit - Downlight

Lighting facts
A Program of the U.S. DOE

Light Output (Lumens)	615
Watts	10
Lumens per Watt (Efficacy)	61
Color Accuracy Color Rendering Index (CRI)	90
Light Color Correlated Color Temperature (CCT)	3000 (Bright White)

Warm White 2700K 3000K Bright White 4500K Daylight 6500K

All results are according to IESNA LM-79-2008. Approved Method for the Electrical and Photometric Testing of Solid-State Lighting. The U.S. Department of Energy (DOE) verifies product test data and results.

Visit www.lightingfacts.com for the Label Reference Guide.

Registration Number: F4QJ15CJ0B (10/25/2013)
Model Number: RA406930WH
Type: Retrofit Kit - Downlight

Lighting facts
A Program of the U.S. DOE

Light Output (Lumens)	640
Watts	10
Lumens per Watt (Efficacy)	64
Color Accuracy Color Rendering Index (CRI)	90
Light Color Correlated Color Temperature (CCT)	2700 (Warm White)

Warm White 2700K 3000K Bright White 4500K Daylight 6500K

All results are according to IESNA LM-79-2008. Approved Method for the Electrical and Photometric Testing of Solid-State Lighting. The U.S. Department of Energy (DOE) verifies product test data and results.

Visit www.lightingfacts.com for the Label Reference Guide.

Registration Number: F4QJ-OTFN0L (10/25/2013)
Model Number: RA406927NFLWH
Type: Retrofit Kit - Downlight

Lighting facts
A Program of the U.S. DOE

Light Output (Lumens)	640
Watts	10
Lumens per Watt (Efficacy)	64
Color Accuracy Color Rendering Index (CRI)	90
Light Color Correlated Color Temperature (CCT)	3000 (Bright White)

Warm White 2700K 3000K Bright White 4500K Daylight 6500K

All results are according to IESNA LM-79-2008. Approved Method for the Electrical and Photometric Testing of Solid-State Lighting. The U.S. Department of Energy (DOE) verifies product test data and results.

Visit www.lightingfacts.com for the Label Reference Guide.

Registration Number: F4QJ4LD24Z (10/25/2013)
Model Number: RA406930NFLWH
Type: Retrofit Kit - Downlight

For further information refer to the Lighting Facts website at <http://lightingfacts.com/>.

ORDERING INFORMATION

SAMPLE NUMBER: RA406930WH

Complete unit includes RA4 LED and a compatible 4" housing; ordered separately.

RA4 Series	Accessory (order separately)
<p>Very Wide Flood - VWFL Models RA406927WH= 4" LED Adjustable Gimbal, 90CRI, 2700K, White, Very Wide Flood RA406930WH= 4" LED Adjustable Gimbal, 90CRI, 3000K, White, Very Wide Flood</p> <p>Narrow Flood - NFL Models RA406927NFLWH= 4" LED Adjustable Gimbal, 90CRI, 2700K, White, Narrow Flood RA406930NFLWH= 4" LED Adjustable Gimbal, 90CRI, 3000K, White, Narrow Flood</p> <p>California non-E26 Models SLD405927WH-CA SLD405930WH-CA SSLD405935WH-CA SSLD405940WH-CA</p>	<p>HE26LED=Replacement screw base adapter (one included with unit)</p>

Housing
<p>H995ICAT= 4" LED Insulated Ceiling, AIR-TITE New Construction Housing with LED luminaire connector (high efficacy compliant) H995RICAT= 4" LED Insulated Ceiling, AIR-TITE Remodel Housing with LED luminaire connector (high efficacy compliant)</p>

HOUSING COMPATIBILITY

The RA4 is UL Listed in Halo and All-Pro recessed housings, and is UL Classified for use with any 4 inch diameter recessed housing constructed of steel or aluminum with an internal volume that exceeds 62.3 in³ in addition to those noted below:

Compatible Halo LED Housings with LED luminaire connector (high-efficacy compliant)		
HALO LED	Recessed Can Size	Catalog Number
		4"
Compatible Halo Incandescent E26 Screwbase Housings		
HALO	Recessed Can Size	Catalog Number
		4"

PHOTOMETRY

RA406927WH
 Reflector Beam Angle = VWFL Beam
 (Very Wide Flood)
 CCT = 2700K
 Spacing Criteria = 1.18
 Lumens per Watt = 60 Lm/W
 Test No. P121906
 Test Model: RA406927WH

Cone of Light Footcandles 0 deg Aiming Angle Horizontal Illuminance on Floor				
Distance to Illuminated Plane	Initial Nadir Footcandles	Beam (ft.)		
		L Length	W Width	
5.5'	9.7	6.4	6.4	
7'	6	8.2	8.2	
8'	4.6	9.4	9.4	
9'	3.6	10.6	10.6	
10'	2.9	11.8	11.8	

Cone of Light Footcandles 35 deg Aiming Angle Vertical Illuminance on Wall				
Distance to Illuminated Plane	Initial Nadir Footcandles	Beam (ft.)		CB
		L Length	W Width	
2'	43.5	2.1	2.4	2.9
3'	19.3	3.2	3.6	4.3
4'	10.9	4.2	4.8	5.7
5'	7	5.3	6	7.1
6'	4.8	6.4	7.4	8.6
8'	2.7	8.6	9.8	11.4
10'	1.7	10.8	12.2	14.3

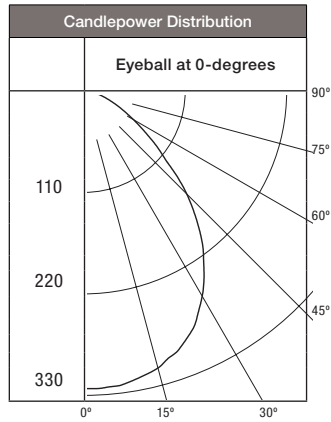

Candela Distribution	
Degrees Vertical	Candela
0*	293
5	293
15	283
25	257
35	206
45	144
55	79
65	40
75	18
85	6
90	0

Luminance (Average Candela/M ²)	
Degree	Avg. 0° Luminance
45	43944
55	29652
65	20532
75	15132
85	14648

Zonal Lumen Summary		
Zone	Lumens	% Fixture
0-30	225	37.4
0-40	354	58.9
0-60	534	89.0
0-90	600	100

*CBCP

RA406930WH
 Reflector Beam Angle = VWFL Beam
 (Very Wide Flood)
 CCT = 3000K
 Spacing Criteria = 1.18
 Lumens per Watt = 61.5 Lm/W
 Test No. P121908
 Test Model: RA406930WH

Cone of Light Footcandles 0 deg Aiming Angle Horizontal Illuminance on Floor				
Distance to Illuminated Plane	Initial Nadir Footcandles	Beam (ft.)		
		L Length	W Width	
5.5'	9.9	6.4	6.4	
7'	6.1	8.2	8.2	
8'	4.7	9.4	9.4	
9'	3.7	10.6	10.6	
10'	3	11.8	11.8	

Cone of Light Footcandles 35 deg Aiming Angle Vertical Illuminance on Wall				
Distance to Illuminated Plane	Initial Nadir Footcandles	Beam (ft.)		CB
		L Length	W Width	
2'	44.6	2.1	2.4	2.9
3'	19.8	3.2	3.6	4.3
4'	11.1	4.2	4.8	5.7
5'	7.1	5.3	6	7.1
6'	5	6.4	7.4	8.6
8'	2.8	8.6	9.8	11.4
10'	1.8	10.8	12.2	14.3

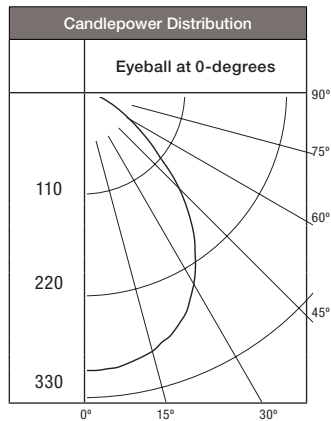

Candela Distribution	
Degrees Vertical	Candela
0*	301
5	300
15	290
25	263
35	211
45	147
55	81
65	41
75	19
85	6
90	0

Luminance (Average Candela/M ²)	
Degree	Avg. 0° Luminance
45	45015
55	30407
65	21044
75	15551
85	14896

Zonal Lumen Summary		
Zone	Lumens	% Fixture
0-30	230	37.4
0-40	362	58.9
0-60	548	89.0
0-90	615	100

*CBCP

PHOTOMETRY

RA406927NFLWH
 Reflector Beam Angle = NFL Beam (Narrow Flood)
 CCT = 2700K
 Spacing Criteria = 0.35
 Lumens per Watt = 64 Lm/W
 Test No. P121904
 Test Model: RA406927NFLWH

Cone of Light Footcandles 0 deg Aiming Angle Horizontal Illuminance on Floor			
Distance to Illuminated Plane	Initial Nadir Footcandles	Beam (ft.)	
		L Length	W Width
5.5'	98.7	1.8	1.8
7'	60.9	2.4	2.4
8'	46.6	2.8	2.8
9'	36.9	3	3
10'	29.9	3.4	3.4

Cone of Light Footcandles 35 deg Aiming Angle Vertical Illuminance on Wall				
Distance to Illuminated Plane	Initial Nadir Footcandles	Beam (ft.)		
		L Length	W Width	CB
2'	168	1.7	1	2.9
3'	74.7	2.6	1.6	4.3
4'	42	3.5	2.2	5.7
5'	26.9	4.4	2.8	7.1
6'	18.7	5.3	3.4	8.6
8'	10.5	7.1	4.4	11.4
10'	6.7	8.9	5.6	14.3

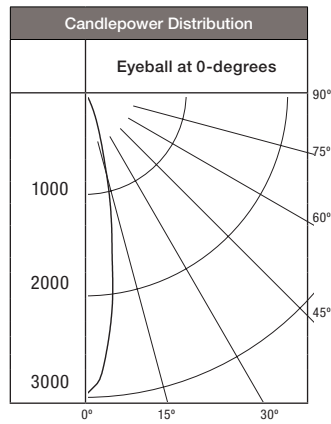

Candela Distribution	
Degrees Vertical	Candela
0*	2985
5	2531
15	836
25	223
35	62
45	27
55	14
65	6
75	2
85	0
90	0

Luminance (Average Candela/M ²)	
Degree	Avg. 0° Luminance
45	6559
55	3723
65	1726
75	577
85	168

Zonal Lumen Summary		
Zone	Lumens	% Fixture
0-30	556	86.9
0-40	598	93.4
0-60	631	98.7
0-90	640	100

*CBCP

RA406930NFLWH
 Reflector Beam Angle = NFL Beam (Narrow Flood)
 CCT = 3000K
 Spacing Criteria = 0.35
 Lumens per Watt = 64 Lm/W
 Test No. P121905
 Test Model: RA406930NFLWH

Cone of Light Footcandles 0 deg Aiming Angle Horizontal Illuminance on Floor			
Distance to Illuminated Plane	Initial Nadir Footcandles	Beam (ft.)	
		L Length	W Width
5.5'	98.7	1.8	1.8
7'	60.9	2.4	2.4
8'	46.6	2.8	2.8
9'	36.9	3	3
10'	29.9	3.4	3.4

Cone of Light Footcandles 35 deg Aiming Angle Vertical Illuminance on Wall				
Distance to Illuminated Plane	Initial Nadir Footcandles	Beam (ft.)		
		L Length	W Width	CB
2'	168	1.7	1	2.9
3'	74.7	2.6	1.6	4.3
4'	42	3.5	2.2	5.7
5'	26.9	4.4	2.8	7.1
6'	18.7	5.3	3.4	8.6
8'	10.5	7.1	4.4	11.4
10'	6.7	8.9	5.6	14.3

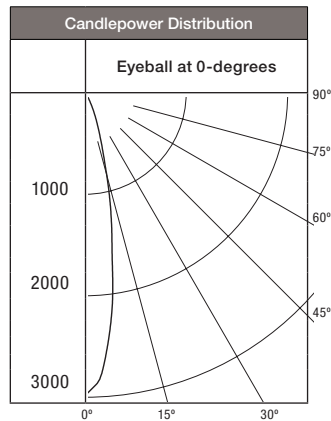

Candela Distribution	
Degrees Vertical	Candela
0*	2985
5	2531
15	836
25	223
35	62
45	27
55	14
65	6
75	2
85	0
90	0

Luminance (Average Candela/M ²)	
Degree	Avg. 0° Luminance
45	6559
55	3723
65	1726
75	577
85	168

Zonal Lumen Summary		
Zone	Lumens	% Fixture
0-30	556	86.9
0-40	598	93.4
0-60	631	98.7
0-90	640	100

*CBCP