

Pico® Wireless Control (for North, Central, and South America)

The Pico® wireless control is a flexible and easy to use device that allows the user to control Lutron® wireless load-control devices from anywhere in the space. This battery-operated control requires no external power or communication wiring.

Features

- Provides control for the following:
 - Caséta® Wireless controls
 - Energi Savr Node™, Quantum®, and myRoom™ systems, through the use of a QS sensor module (QSM)
 - Vive™ systems, including:
 - Maestro Wireless® controls
 - PowPak® modules
 - GRAFIK Eye® QS wireless systems
 - HomeWorks® QS wireless systems
 - Maestro Wireless® controls
 - PowPak® modules
 - RadioRA® 2 systems
 - Serena® RF remote control shades
 - Sivoia® QS wireless systems
- Control available in a variety of button marking options.
- Easy reconfiguration for use as:
 - Handheld remote
 - Wall-mount control (with or without faceplate; faceplate adapter kit sold separately)
 - Car visor control (car visor clip sold separately)
 - A table top control (table top pedestal sold separately).
- Battery-powered. Requires no wiring.
- 10 year battery life (one CR2032 battery included).
- Can provide control of blinds, curtains, or lighting devices within a range of 30 ft (9 m) through walls and 60 ft (18 m) line-of-sight.
- BAA-compliant model numbers available. Add a “U” prefix to the model number.

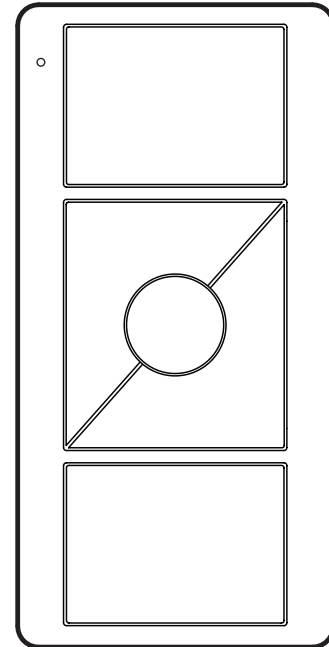

Pico® wireless control

Job Name:	Model Numbers:
Job Number:	

Specifications

Regulatory Approvals

- Lutron® Quality Systems registered to ISO 9001:2008.
- FCC Certified (U.S.A.)
- IC Certified (Canada)
- COFETEL Certified (Mexico)
- SUTEL Certified (Costa Rica)
- Anatel Certified (Brazil)

Power

- Operating Voltage 3 V_{DC}
- (1) CR2032 Battery (included)

System Communication and Capacity

- Communicates using Radio Frequency (RF) at 431 MHz to 437 MHz.
- Thousands of system addresses prevent interference between systems.
- Can be assigned to control blinds, curtains or lighting devices that are within a 30 ft (9 m) range.
- Can be configured as a scene or zone control in GRAFIK Eye® QS wireless applications.

Mounting Considerations

- Mounting of any RF devices on or in close proximity to a metal surface will drastically reduce the effective range of radio signal transmission or reception.
- All RF devices must be mounted on non-conductive materials to ensure proper performance.
- If you wish to mount your Pico® wireless control to a metal surface, the PICO-MOUNT-1-XX-CPN5733 will be required in order to maintain proper RF performance. For availability, please contact your local Lutron® sales office.

Environment

- Ambient operating temperature: 32 °F to 140 °F (0 °C to 60 °C)
- Maximum 90% non-condensing relative humidity
- Indoor use only

Warranty

- 1 Year Limited Warranty
For additional Warranty information, please visit www.lutron.com/TechnicalDocumentLibrary/369-119_Wallbox_Warranty.pdf

Job Name:	Model Numbers:
Job Number:	

Model Number

For order quantities of 96 pieces or greater of the same model number, bulk packaging may be available. Mounting hardware is not included with bulk packaging. Please contact Lutron® Customer Service for availability at 1.888.LUTRON1 (1.888.588.7661).

PJ2-XXXX-GXX-XXX

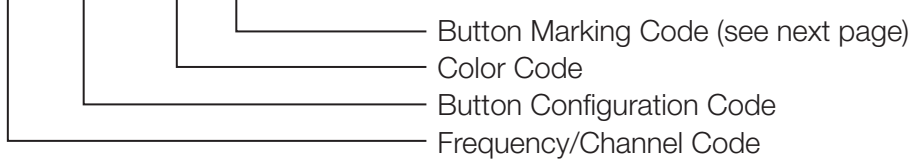

Frequency/Channel Codes:

Code

J — 431.0 - 437.0 MHz

Button Configuration Codes:

<u>Button Configuration</u>	<u>Code</u>
2 Button	2B
2 Button with Raise/Lower	2BRL
3 Button	3B
3 Button with Raise/Lower	3BRL

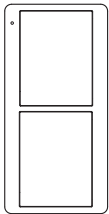

2 Button
(2B)

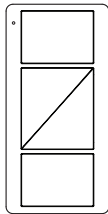

2 Button with
Raise/Lower
(2BRL)

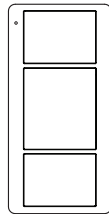

3 Button
(3B)

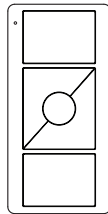

3 Button with
Raise/Lower
(3BRL)

Color Codes:

<u>Gloss Color</u>	<u>Code</u>
White	WH
Black	BL
Ivory	IV
Light Almond	LA
White/Gray	WG (Top and Raise buttons are White; Preset, Lower, and Bottom buttons are Gray)

Continued on next page...

Job Name:	Model Numbers:
Job Number:	

Model Number (continued)

PJ2-XXXX-GXX-XXX

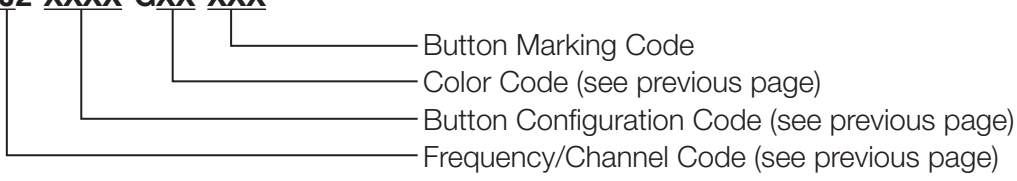

Button Marking Codes:

2 Button

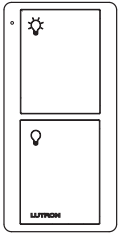

Light (L01)

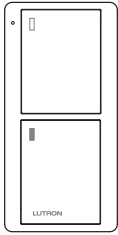

Appliance (L02)

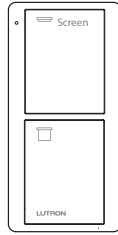

Screen (S08)

2 Button with Raise/Lower

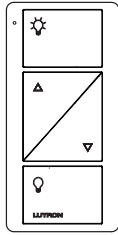

Light (L01)

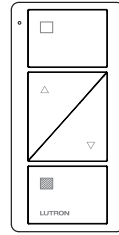

Shade (icons) (S01)

3 Button

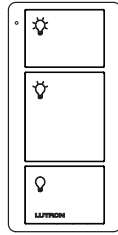

Light (L01)

3 Button with Raise/Lower

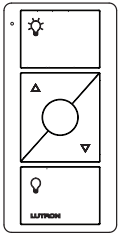

Light (L01)

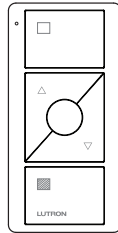

Shade (icons) (S01)

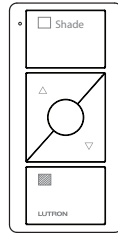

Shade (text) (S02)

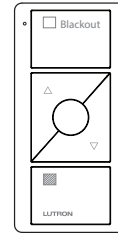

Blackout (S03)

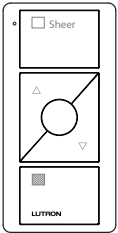

Sheer (S04)

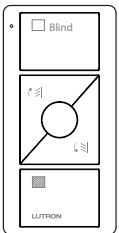

Blind (S05)

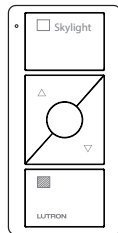

Skylight (S06)

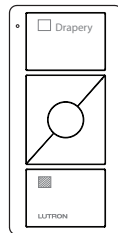

Drapery (S07)

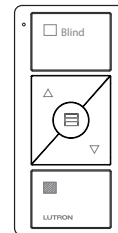

Blind (S09)

<p>Job Name:</p> <p>Job Number:</p>	<p>Model Numbers:</p>
--	-----------------------

Operation

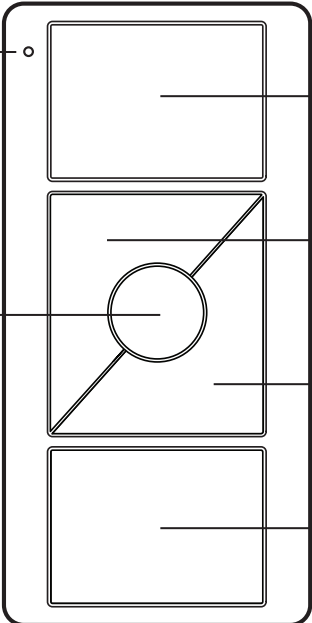

Indicator LED
Flashes to indicate a button press or when unit is in programming mode.

Top Button
Lights brighten to full intensity and shades/ draperies go to open limit. Activates scene 1 when used in scene mode with GRAFIK Eye® QS wireless applications.

Preset Button (3B & 3BRL models only)
Tap once:
Devices go to preset levels/positions. Activates scene 16 when used in scene mode with GRAFIK Eye® QS wireless applications.
Press and hold:
To save new preset level or position, press and hold for 6 seconds.

Raise Button (2BRL & 3BRL models only)
Lights increase in intensity and shades/ draperies move towards open limit.

Lower Button (2BRL & 3BRL models only)
Lights decrease in intensity and shades/ draperies move towards close limit.

Bottom Button
Lights dim to off and shades/ draperies go to close limit. Activates "OFF" scene when used in scene mode with GRAFIK Eye® QS wireless applications.

Dimensions

Measurements shown as: in (mm)

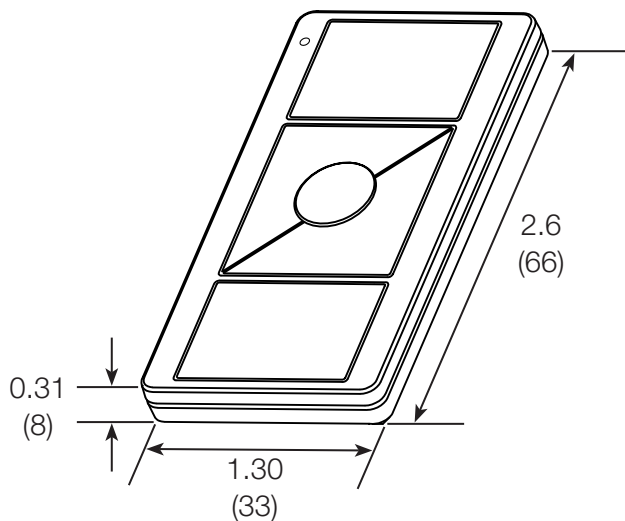

<p>Job Name:</p> <p>Job Number:</p>	<p>Model Numbers:</p>
--	-----------------------

Pico® Pedestal Model Number

Pedestals sold separately. Available in gloss finish only.

L-PEDX-XX

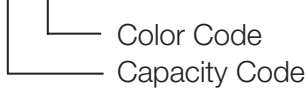

Capacity Codes:

Capacity	Code
Single	1
Double	2
Triple	3
Quadruple	4

Color Codes:

Gloss Color	Code
White	WH
Black	BL

Dimensions

Measurements shown as: in (mm)

Single Pedestal

Pedestals sold separately.

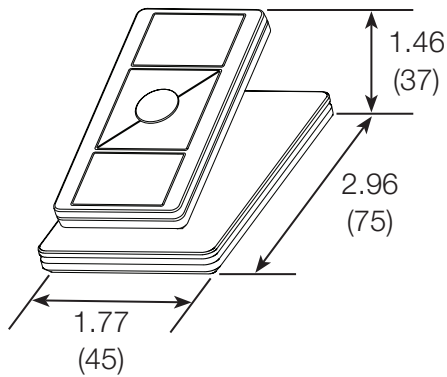

Double Pedestal

Pedestals sold separately.

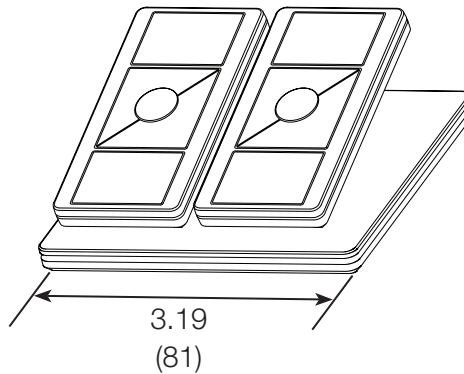

Triple Pedestal

Pedestals sold separately.

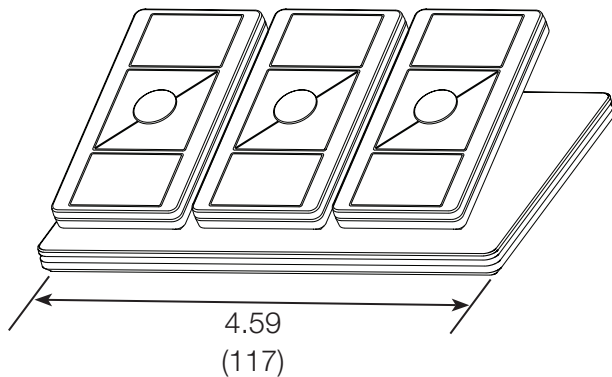

Quadruple Pedestal

Pedestals sold separately.

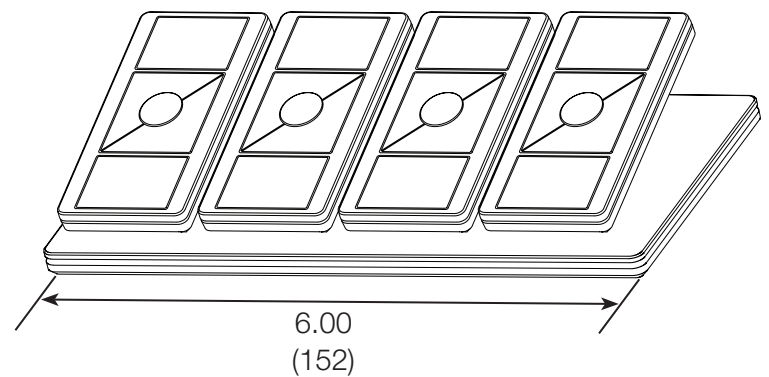

Job Name:	Model Numbers:
Job Number:	

Mounting Options

Stand Alone Mounting

Adhesive-Mount

(included with Pico® wireless control)

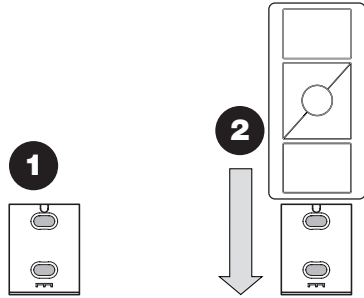

Screw-Mount (sold separately)

Model PICO-SM-KIT

Note: Kit includes special screws to be used for more permanent mounting and/or for non-smooth surfaces.

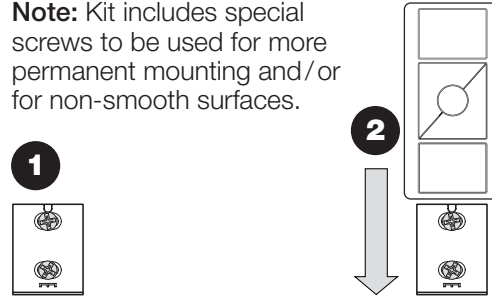

Wallbox Adapter

Model PICO-WBX-ADAPT

(sold separately)

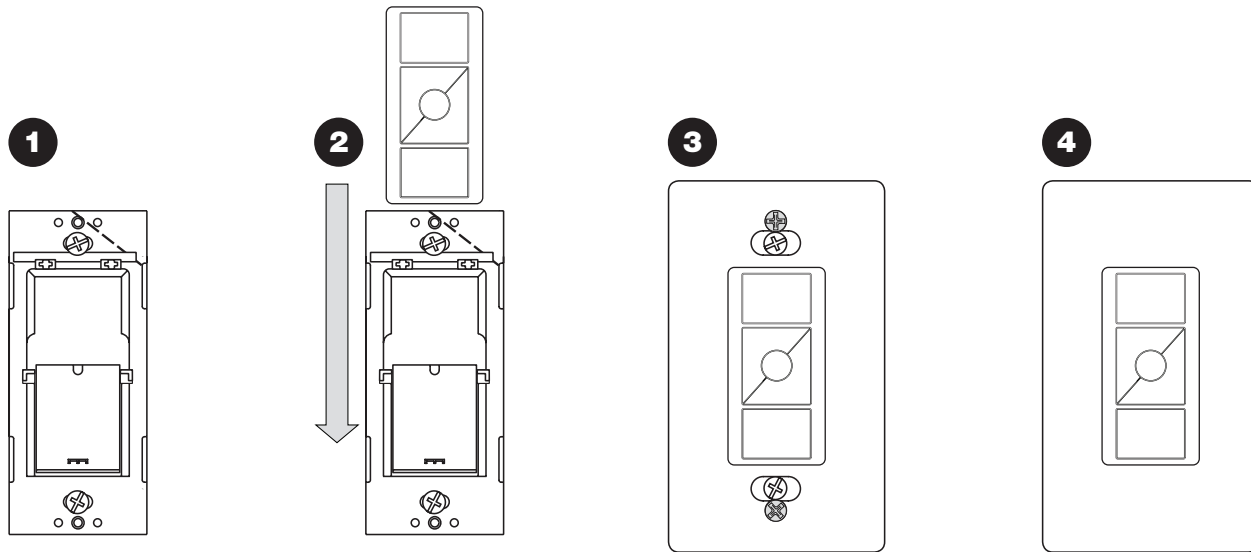

*Wallplate adapter / wallplate sold separately

Continued on next page...

LUTRON SPECIFICATION SUBMITTAL

Page:

Job Name:	Model Numbers:
Job Number:	

Mounting Options *(continued)*

Wall-Mounting Kit

Model PJ2-WALL-WH-L01R
(sold separately)

Kit includes:

- Pico® wireless control
- Claro® wallplate (with wallplate adapter)
- Wallbox adapter

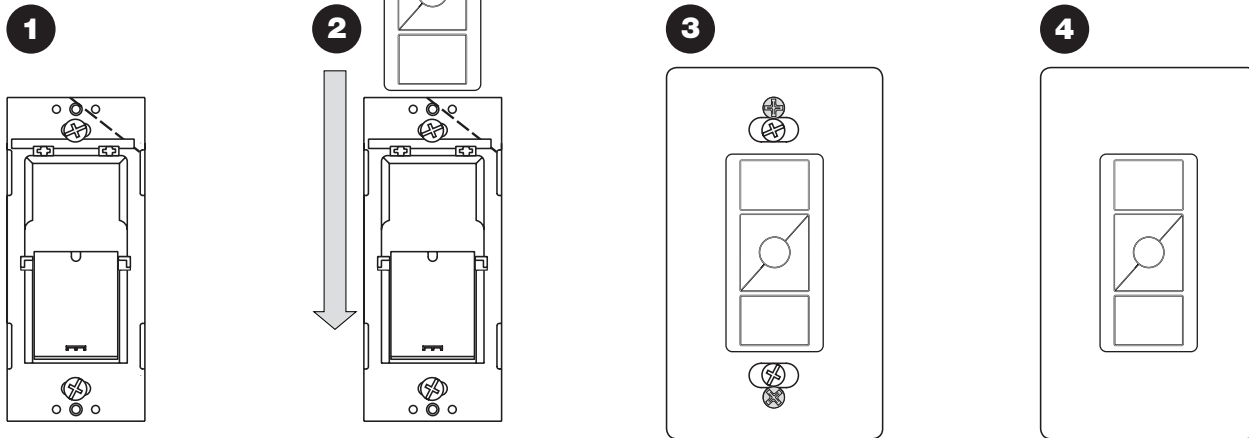

Mounting to Metal Surfaces

Model: PICO-MOUNT-1-XX-CPN5733 (sold separately)

Contact your local
Lutron® sales office.

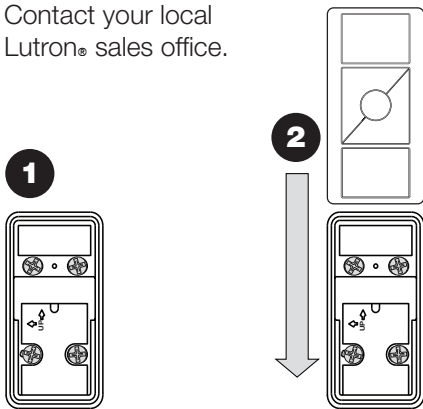

Car Visor

Model PICO-CARVISOR-CL (sold separately)

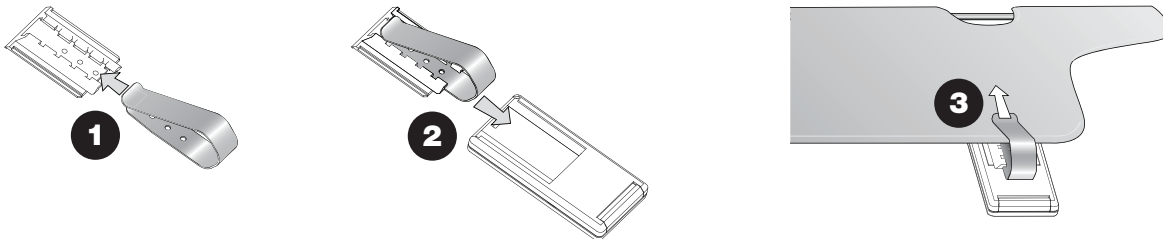

Job Name:	Model Numbers:
Job Number:	

Pico® Wireless Control (for North, Central, and South America)

The Pico® wireless control is a flexible and easy to use device that allows the user to control Lutron® wireless load-control devices from anywhere in the space. This battery-operated control requires no external power or communication wiring.

Features

- Provides control for the following:
 - Caséta® Wireless controls
 - Energi Savr Node™, Quantum®, and myRoom™ systems, through the use of a QS sensor module (QSM)
 - Vive™ systems, including:
 - Maestro Wireless® controls
 - PowPak® modules
 - GRAFIK Eye® QS wireless systems
 - HomeWorks® QS wireless systems
 - Maestro Wireless® controls
 - PowPak® modules
 - RadioRA® 2 systems
 - Serena® RF remote control shades
 - Sivoia® QS wireless systems
- Control available in a variety of button marking options.
- Easy reconfiguration for use as:
 - Handheld remote
 - Wall-mount control (with or without faceplate; faceplate adapter kit sold separately)
 - Car visor control (car visor clip sold separately)
 - A table top control (table top pedestal sold separately).
- Battery-powered. Requires no wiring.
- 10 year battery life (one CR2032 battery included).
- Can provide control of blinds, curtains, or lighting devices within a range of 30 ft (9 m) through walls and 60 ft (18 m) line-of-sight.
- BAA-compliant model numbers available. Add a “U” prefix to the model number.

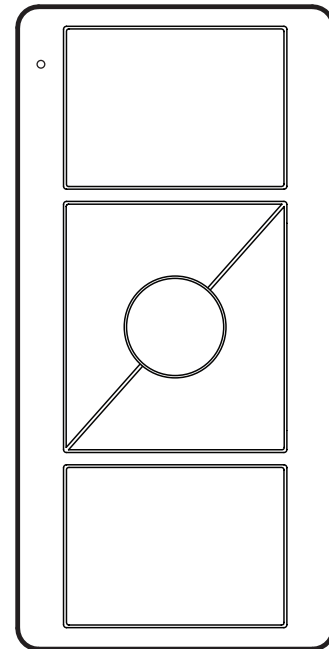

Pico® wireless control

Job Name:	Model Numbers:
Job Number:	

Specifications

Regulatory Approvals

- Lutron® Quality Systems registered to ISO 9001:2008.
- FCC Certified (U.S.A.)
- IC Certified (Canada)
- COFETEL Certified (Mexico)
- SUTEL Certified (Costa Rica)
- Anatel Certified (Brazil)

Power

- Operating Voltage 3 V_{DC}
- (1) CR2032 Battery (included)

System Communication and Capacity

- Communicates using Radio Frequency (RF) at 431 MHz to 437 MHz.
- Thousands of system addresses prevent interference between systems.
- Can be assigned to control blinds, curtains or lighting devices that are within a 30 ft (9 m) range.
- Can be configured as a scene or zone control in GRAFIK Eye® QS wireless applications.

Mounting Considerations

- Mounting of any RF devices on or in close proximity to a metal surface will drastically reduce the effective range of radio signal transmission or reception.
- All RF devices must be mounted on non-conductive materials to ensure proper performance.
- If you wish to mount your Pico® wireless control to a metal surface, the PICO-MOUNT-1-XX-CPN5733 will be required in order to maintain proper RF performance. For availability, please contact your local Lutron® sales office.

Environment

- Ambient operating temperature: 32 °F to 140 °F (0 °C to 60 °C)
- Maximum 90% non-condensing relative humidity
- Indoor use only

Warranty

- 1 Year Limited Warranty
For additional Warranty information, please visit www.lutron.com/TechnicalDocumentLibrary/369-119_Wallbox_Warranty.pdf

Job Name:	Model Numbers:
Job Number:	

Model Number

For order quantities of 96 pieces or greater of the same model number, bulk packaging may be available. Mounting hardware is not included with bulk packaging. Please contact Lutron® Customer Service for availability at 1.888.LUTRON1 (1.888.588.7661).

PJ2-XXXX-GXX-XXX

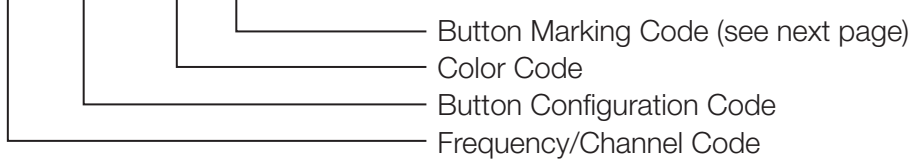

Frequency/Channel Codes:

Code

J — 431.0 - 437.0 MHz

Button Configuration Codes:

<u>Button Configuration</u>	<u>Code</u>
2 Button	2B
2 Button with Raise/Lower	2BRL
3 Button	3B
3 Button with Raise/Lower	3BRL

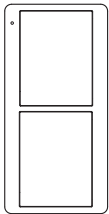

2 Button
(2B)

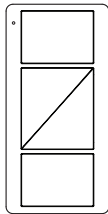

2 Button with
Raise/Lower
(2BRL)

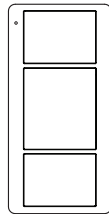

3 Button
(3B)

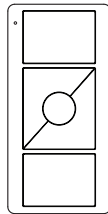

3 Button with
Raise/Lower
(3BRL)

Color Codes:

<u>Gloss Color</u>	<u>Code</u>
White	WH
Black	BL
Ivory	IV
Light Almond	LA
White/Gray	WG (Top and Raise buttons are White; Preset, Lower, and Bottom buttons are Gray)

Continued on next page...

<p>Job Name:</p> <p>Job Number:</p>	<p>Model Numbers:</p>
--	------------------------------

Model Number (continued)

PJ2-XXXX-GXX-XXX

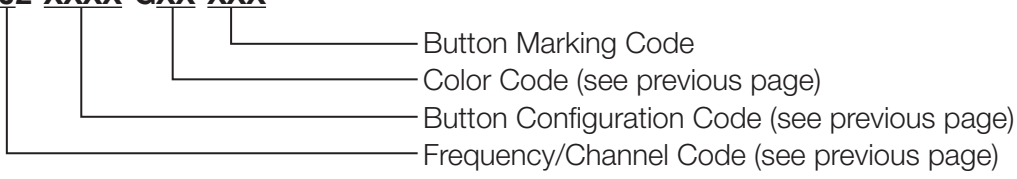

Button Marking Codes:

2 Button

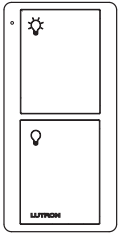

Light (L01)

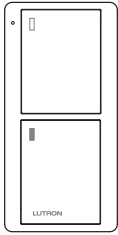

Appliance (L02)

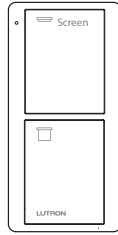

Screen (S08)

2 Button with Raise/Lower

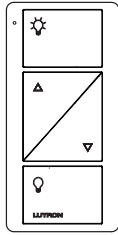

Light (L01)

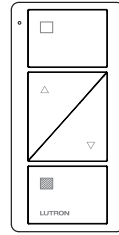

Shade (icons) (S01)

3 Button

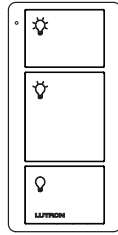

Light (L01)

3 Button with Raise/Lower

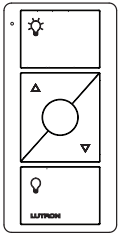

Light (L01)

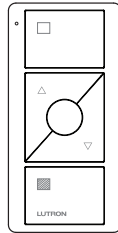

Shade (icons) (S01)

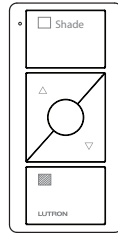

Shade (text) (S02)

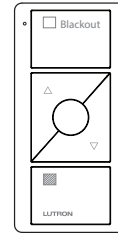

Blackout (S03)

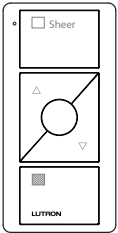

Sheer (S04)

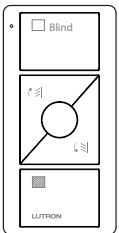

Blind (S05)

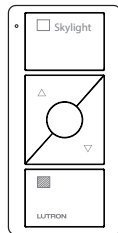

Skylight (S06)

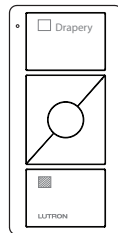

Drapery (S07)

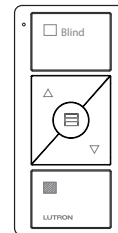

Blind (S09)

<p>Job Name:</p> <p>Job Number:</p>	<p>Model Numbers:</p>
--	-----------------------

Operation

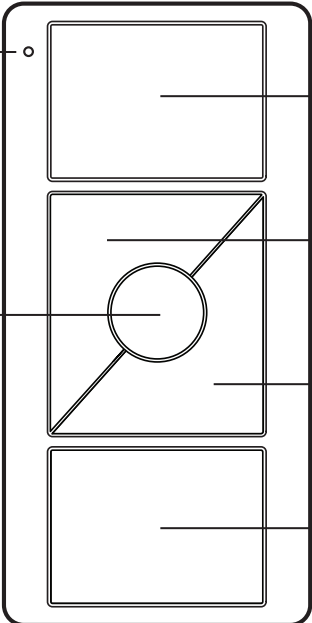

Indicator LED
Flashes to indicate a button press or when unit is in programming mode.

Top Button
Lights brighten to full intensity and shades/ draperies go to open limit. Activates scene 1 when used in scene mode with GRAFIK Eye® QS wireless applications.

Preset Button (3B & 3BRL models only)
Tap once:
Devices go to preset levels/positions. Activates scene 16 when used in scene mode with GRAFIK Eye® QS wireless applications.
Press and hold:
To save new preset level or position, press and hold for 6 seconds.

Raise Button (2BRL & 3BRL models only)
Lights increase in intensity and shades/ draperies move towards open limit.

Lower Button (2BRL & 3BRL models only)
Lights decrease in intensity and shades/ draperies move towards close limit.

Bottom Button
Lights dim to off and shades/ draperies go to close limit. Activates "OFF" scene when used in scene mode with GRAFIK Eye® QS wireless applications.

Dimensions

Measurements shown as: in (mm)

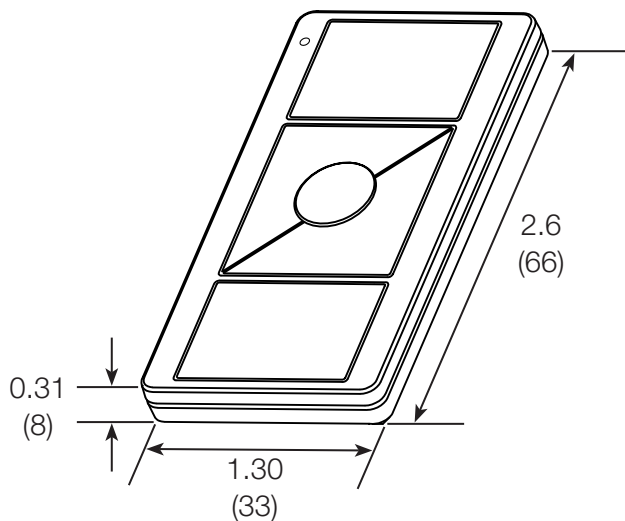

<p>Job Name:</p> <p>Job Number:</p>	<p>Model Numbers:</p>
--	-----------------------

Pico® Pedestal Model Number

Pedestals sold separately. Available in gloss finish only.

L-PEDX-XX

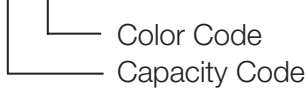

Capacity Codes:

Capacity	Code
Single	1
Double	2
Triple	3
Quadruple	4

Color Codes:

Gloss Color	Code
White	WH
Black	BL

Dimensions

Measurements shown as: in (mm)

Single Pedestal

Pedestals sold separately.

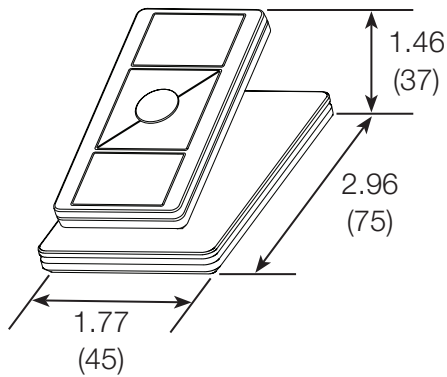

Double Pedestal

Pedestals sold separately.

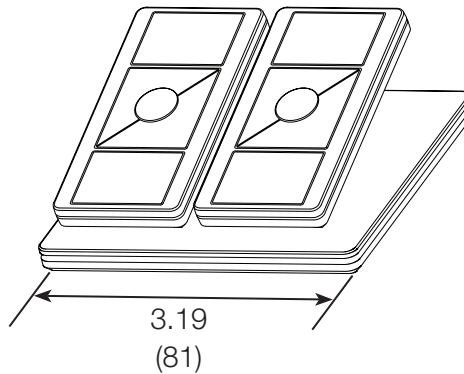

Triple Pedestal

Pedestals sold separately.

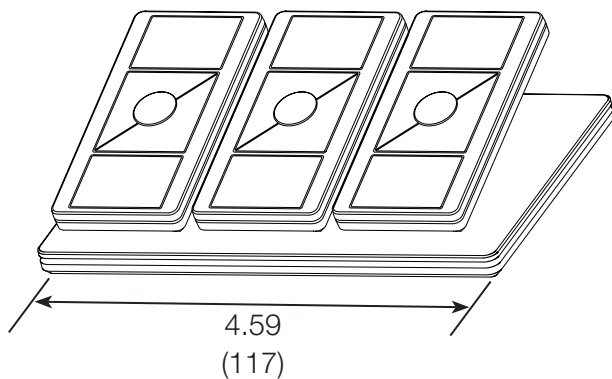

Quadruple Pedestal

Pedestals sold separately.

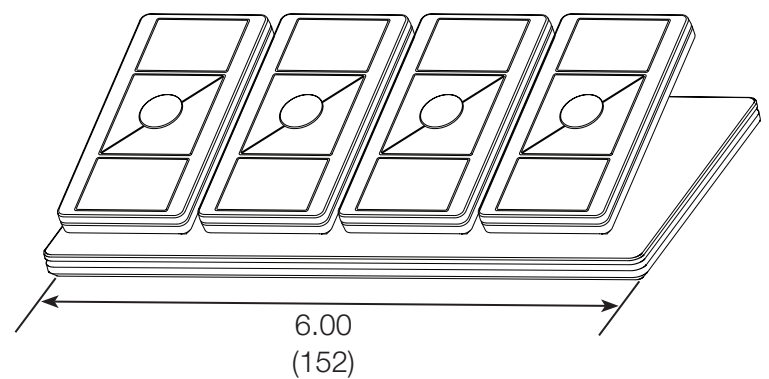

Job Name:	Model Numbers:
Job Number:	

Mounting Options

Stand Alone Mounting

Adhesive-Mount
(included with Pico® wireless control)

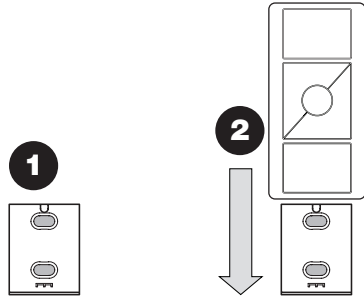

Screw-Mount (sold separately)
Model PICO-SM-KIT

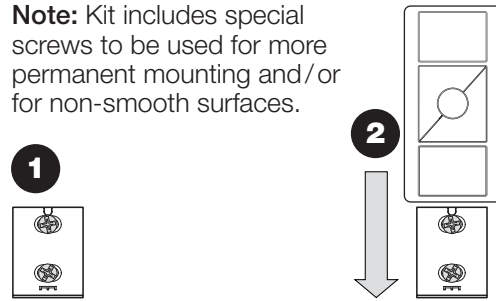

Note: Kit includes special screws to be used for more permanent mounting and/or for non-smooth surfaces.

Wallbox Adapter

Model PICO-WBX-ADAPT
(sold separately)

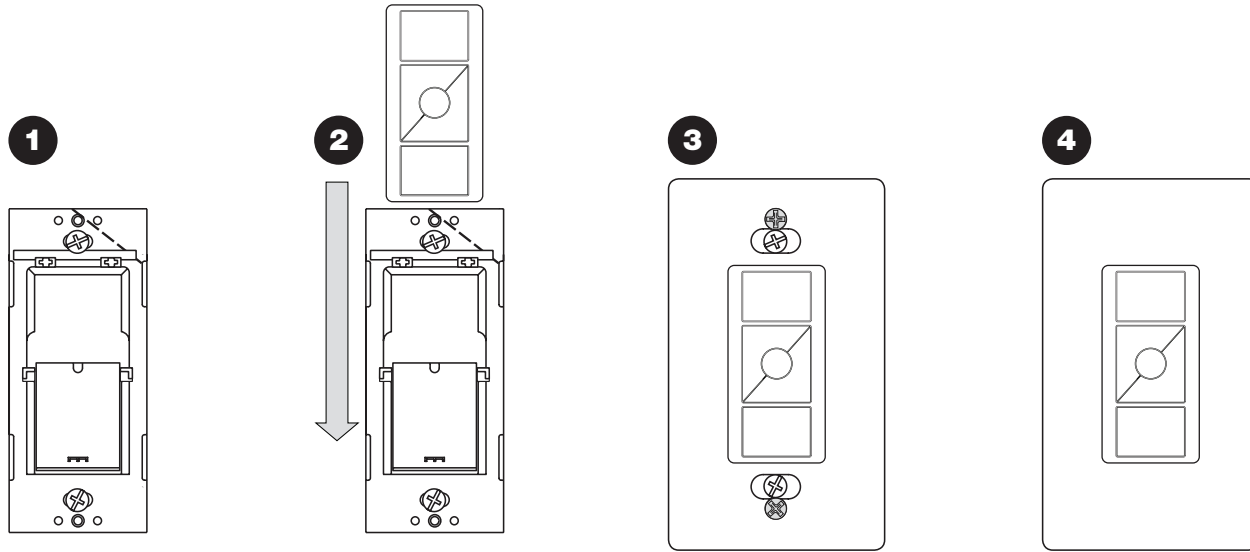

*Wallplate adapter / wallplate sold separately

Continued on next page...

Job Name:	Model Numbers:
Job Number:	

Mounting Options (continued)

Wall-Mounting Kit

Model PJ2-WALL-WH-L01R
(sold separately)

Kit includes:

- Pico® wireless control
- Claro® wallplate (with wallplate adapter)
- Wallbox adapter

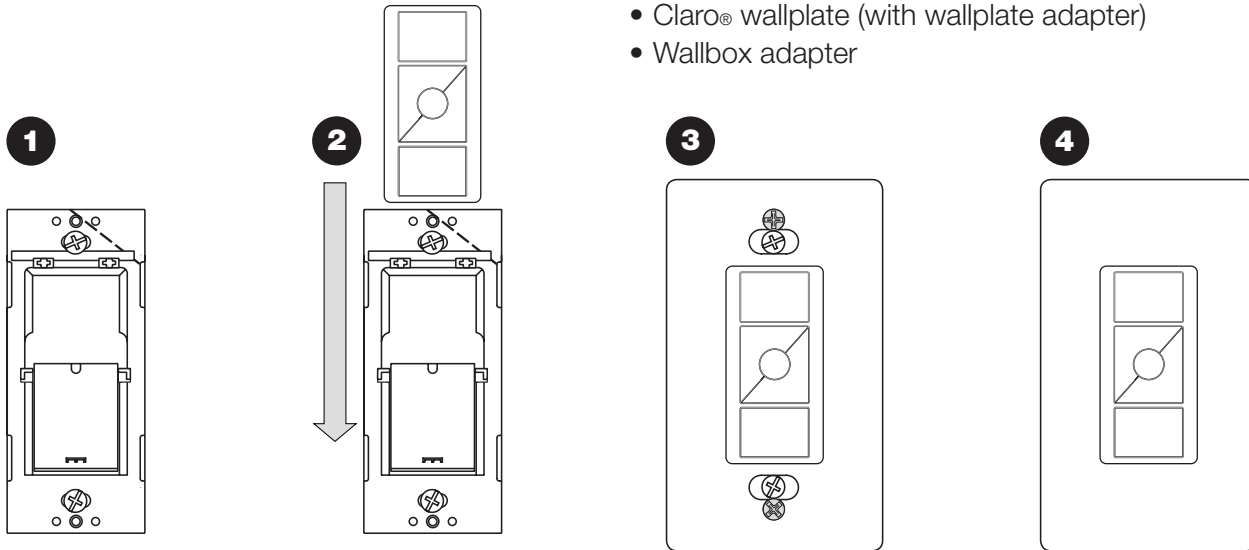

Mounting to Metal Surfaces

Model: PICO-MOUNT-1-XX-CPN5733 (sold separately)

Contact your local Lutron® sales office.

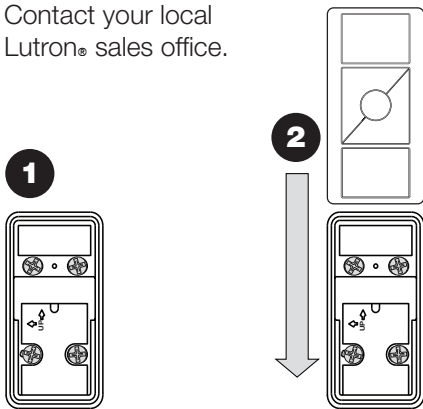

Car Visor

Model PICO-CARVISOR-CL (sold separately)

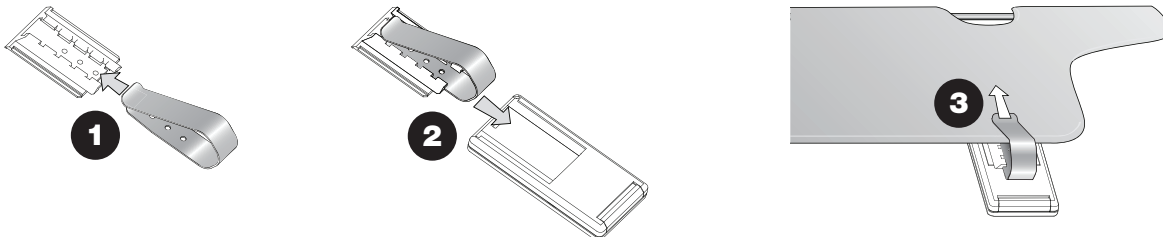

Job Name:	Model Numbers:
Job Number:	