

P1109 thru P1126

Pipe Clamps for Rigid Steel Conduit



Slotted hex head screw and nut included.  
Finish: Electro-galvanized.

Part Number	Pipe Size In	O.D. Size In (mm)	Thickness Gauge (mm)	Wt/100 pcs Lbs (kg)	Design Load Lbs (kg)
P1109	3/8	0.675 17.1	16 1.5	10 4.5	400 181
P1111	1/2	0.840 21.3	16 1.5	11 5.0	400 181
P1112	3/4	1.050 26.7	14 1.9	15 6.8	600 272
P1113	1	1.315 33.4	14 1.9	17 7.7	600 272
P1114	1 1/4	1.660 42.2	14 1.9	19 8.6	600 272
P1115	1 1/2	1.900 48.3	12 2.7	29 13.2	800 363
P1117	2	2.375 60.3	12 2.7	34 15.4	800 363
P1118	2 1/2	2.875 73.0	12 2.7	40 18.1	800 363
P1119	3	3.500 88.9	12 2.7	47 21.3	800 363
P1120	3 1/2	4.000 101.6	11 3.0	62 28.1	1,000 454
P1121	4	4.500 114.3	11 3.0	67 30.4	1,000 454
P1123	5	5.563 141.3	11 3.0	80 36.3	1,000 454
P1124	6	6.625 168.3	10 3.4	102 46.3	1,000 454
P1126	8	8.625 219.1	10 3.4	130 59.0	1,000 454

P1425 thru P1431

Pipe Clamps for Thin Wall Conduit (E.M.T.)

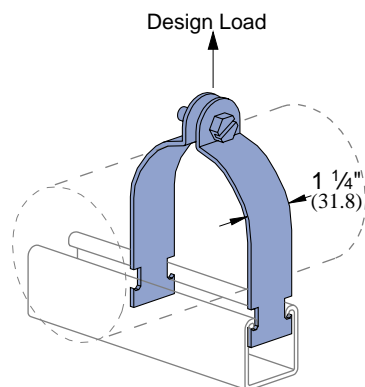

Slotted hex head screw and nut included.  
Finish: Electro-galvanized.

Part Number	Pipe Size In	O.D. Size In (mm)	Thickness Gauge (mm)	Wt/100 pcs Lbs (kg)	Design Load Lbs (kg)
P1425	3/8	0.577 14.7	16 1.5	9 4.1	400 181
P1426	1/2	0.706 17.9	16 1.5	11 5.0	400 181
P1427	3/4	0.922 23.4	16 1.5	12 5.4	400 181
P1428	1	1.163 29.5	14 1.9	15 6.8	600 272
P1429	1 1/4	1.510 38.4	14 1.9	18 8.2	600 272
P1430	1 1/2	1.740 44.2	12 2.7	29 13.2	800 363
P1431	2	2.197 55.8	12 2.7	33 15.0	800 363
P1118	2 1/2	2.875 73.0	12 2.7	40 18.1	800 363
P1119	3	3.500 88.9	12 2.7	47 21.3	800 363
P1120	3 1/2	4.000 101.6	11 3.0	62 28.1	1,000 454
P1121	4	4.500 114.3	11 3.0	67 30.4	1,000 454

15/8" Channel  
Telesnut System  
Nuts & Hardware  
General Fittings  
Pipe/Conduit Supports  
Electrical Fittings  
Concrete Inserts  
1 1/2" Framing System  
1 1/4" Framing System  
1 3/8" Framing System  
Fiberglass System  
Special Metals  
PrimeAngle System  
Product Index

P1648S thru P1653S



Part Number	"A" In	"B" In (mm)	"C" In	"D" In (mm)	Wt/100 pcs Lbs (kg)	Design Load Lbs (kg)
P1648S	1/4 -20	1/8 3.2	3/8 x 1 1/2	7/8 22.2	67 30.4	650 294.8
P1649S	5/16 -18	1/8 3.2	3/8 x 1 1/2	7/8 22.2	67 30.4	650 294.8
P1649AS	3/8 -16	1/8 3.2	3/8 x 1 1/2	7/8 22.2	67 30.4	650 294.8
P1650S	3/8 -16	3/16 4.8	1/2 x 1 1/2	15/16 23.8	100 45.4	1,100 499.0
P1650AS	1/2 -13	3/16 4.8	1/2 x 1 1/2	15/16 23.8	100 45.4	1,100 499.0
P1651S	1/2 -13	1/4 6.4	1/2 x 1 1/2	15/16 23.8	130 59.0	1,600 725.7
P1651AS	5/8 -11	1/4 6.4	1/2 x 1 1/2	15/16 23.8	130 59.0	1,600 725.7
P1652S	5/8 -11	5/16 7.9	5/8 x 1 1/2	15/16 33.3	160 72.6	2,400 1,088.6
P1653S	3/4 -10	5/16 7.9	5/8 x 1 1/2	15/16 33.3	160 72.6	2,400 1,088.6

For beams under 7/8" (22.2) thick flange.

P2398S, P2401S, P2403S



Part Number	"A" In	"B" In (mm)	"C" In	"D" In (mm)	Wt/100 pcs Lbs (kg)	Design Load Lbs (kg)
P2398S	1/4 -20	1/8 3.2	3/8 x 2	1 1/32 42.1	109 49.4	800 362.9
P2401S	3/8 -16	3/16 4.8	1/2 x 2	1 11/16 42.9	156 70.8	1,300 589.7
P2403S	1/2 -13	1/4 6.4	1/2 x 2	1 11/16 42.9	201 91.2	1,900 861.8

For beams between 3/4" (19.1) to 1 1/8" (41.3) thick flanges.





**UNISTRUT®**

# PIPE/CONDUIT SUPPORTS



Pipe/Conduit Clamps .....	139
Unicushion® .....	144
Pipe & Tubing (Cush-A-Clamp®) Clamps .....	146
Pipe Hangers .....	149
Pipe Rollers .....	150
Pipe Brackets .....	153
Reference Tables .....	154

## MATERIAL

Unistrut pipe clamps, unless noted, are punch-press made from hot-rolled, pickled and oiled steel plates, strip or coil, and conform to ASTM specifications A1008, A575, A576, A635, or A36. The fitting steel also meets the physical requirements of ASTM A1011 SS GR 33. The pickling of the steel produces a smooth surface free from scale.

Many items are also available in stainless steel. Consult factory for ordering information.

## FINISHES

Pipe supports are available in:

- Electro-galvanized (EG), conforming to ASTM B633 Type III SC1
- Hot-dipped galvanized (HG), conforming to ASTM A123 or A153 (hardware)
- Perma-Green II (GR), and plain (PL).

## APPLICATION

Unistrut pipe clamps, pipe hangers, brackets and rollers are designed for the support of electrical and mechanical services. Supports to meet nearly every requirement can be attained using Unistrut Metal Framing components.

## DIMENSIONS

Imperial dimensions are illustrated in inches. Metric dimensions are shown in parenthesis or as noted. Unless noted, all metric dimensions are in millimeters and rounded to one decimal place.

## DESIGN BOLT TORQUE

BOLT SIZE	1/4"	5/16"	3/8"	1/2"	5/8"	3/4"
FOOT LBS.	6	11	19	50	100	125
N·m	8	15	25	70	135	170

Note: When tightening 1/4" screws used with a two piece pipe clamp, a torque of 5 foot pounds (60 inch-pounds) should be used.

## DESIGN LOAD

Design load data, where shown, is based on the ultimate strength of the connection with a safety factor of 5.0, unless otherwise noted.

### Pipe Clamps In Special Materials (P1109, P1211, P1425, P2024 Series)

Material	Add Suffix to P/N	Example
Steel Strap, Everdur Hardware	E	P1109 E
Copper Coated Steel Strap & Hardware	CC	P1109 CC
Aluminum	AL	P1109 AL
Stainless Steel 304 or 316	SS or ST	P1109 SS
Plastic Coated Steel Straps	PC	P1109 PC

P1109 thru P1126

Pipe Clamps for Rigid Steel Conduit



Slotted hex head screw and nut included.  
Finish: Electro-galvanized.

Part Number	Pipe Size In	O.D. Size In (mm)	Thickness Gauge (mm)	Wt/100 pcs Lbs (kg)	Design Load Lbs (kg)
P1109	3/8	0.675 17.1	16 1.5	10 4.5	400 181
P1111	1/2	0.840 21.3	16 1.5	11 5.0	400 181
P1112	3/4	1.050 26.7	14 1.9	15 6.8	600 272
P1113	1	1.315 33.4	14 1.9	17 7.7	600 272
P1114	1 1/4	1.660 42.2	14 1.9	19 8.6	600 272
P1115	1 1/2	1.900 48.3	12 2.7	29 13.2	800 363
P1117	2	2.375 60.3	12 2.7	34 15.4	800 363
P1118	2 1/2	2.875 73.0	12 2.7	40 18.1	800 363
P1119	3	3.500 88.9	12 2.7	47 21.3	800 363
P1120	3 1/2	4.000 101.6	11 3.0	62 28.1	1,000 454
P1121	4	4.500 114.3	11 3.0	67 30.4	1,000 454
P1123	5	5.563 141.3	11 3.0	80 36.3	1,000 454
P1124	6	6.625 168.3	10 3.4	102 46.3	1,000 454
P1126	8	8.625 219.1	10 3.4	130 59.0	1,000 454

P1425 thru P1431

Pipe Clamps for Thin Wall Conduit (E.M.T.)



Slotted hex head screw and nut included.  
Finish: Electro-galvanized.

Part Number	Pipe Size In	O.D. Size In (mm)	Thickness Gauge (mm)	Wt/100 pcs Lbs (kg)	Design Load Lbs (kg)
P1425	3/8	0.577 14.7	16 1.5	9 4.1	400 181
P1426	1/2	0.706 17.9	16 1.5	11 5.0	400 181
P1427	3/4	0.922 23.4	16 1.5	12 5.4	400 181
P1428	1	1.163 29.5	14 1.9	15 6.8	600 272
P1429	1 1/4	1.510 38.4	14 1.9	18 8.2	600 272
P1430	1 1/2	1.740 44.2	12 2.7	29 13.2	800 363
P1431	2	2.197 55.8	12 2.7	33 15.0	800 363
P1118	2 1/2	2.875 73.0	12 2.7	40 18.1	800 363
P1119	3	3.500 88.9	12 2.7	47 21.3	800 363
P1120	3 1/2	4.000 101.6	11 3.0	62 28.1	1,000 454
P1121	4	4.500 114.3	11 3.0	67 30.4	1,000 454

15/8" Channel  
Telesnut System  
Nuts & Hardware  
General Fittings  
Pipe/Conduit Supports  
Electrical Fittings  
Concrete Inserts  
1 1/2" Framing System  
1 1/4" Framing System  
1 3/8" Framing System  
Fiberglass System  
Special Metals  
PrimeAngle System  
Product Index

P1648S thru P1653S



Part Number	"A" In	"B" In (mm)	"C" In	"D" In (mm)	Wt/100 pcs Lbs (kg)	Design Load Lbs (kg)
P1648S	1/4 -20	1/8 3.2	3/8 x 1 1/2	7/8 22.2	67 30.4	650 294.8
P1649S	5/16 -18	1/8 3.2	3/8 x 1 1/2	7/8 22.2	67 30.4	650 294.8
P1649AS	3/8 -16	1/8 3.2	3/8 x 1 1/2	7/8 22.2	67 30.4	650 294.8
P1650S	3/8 -16	3/16 4.8	1/2 x 1 1/2	15/16 23.8	100 45.4	1,100 499.0
P1650AS	1/2 -13	3/16 4.8	1/2 x 1 1/2	15/16 23.8	100 45.4	1,100 499.0
P1651S	1/2 -13	1/4 6.4	1/2 x 1 1/2	15/16 23.8	130 59.0	1,600 725.7
P1651AS	5/8 -11	1/4 6.4	1/2 x 1 1/2	15/16 23.8	130 59.0	1,600 725.7
P1652S	5/8 -11	5/16 7.9	5/8 x 1 1/2	15/16 33.3	160 72.6	2,400 1,088.6
P1653S	3/4 -10	5/16 7.9	5/8 x 1 1/2	15/16 33.3	160 72.6	2,400 1,088.6

For beams under 7/8" (22.2) thick flange.

P2398S, P2401S, P2403S



Part Number	"A" In	"B" In (mm)	"C" In	"D" In (mm)	Wt/100 pcs Lbs (kg)	Design Load Lbs (kg)
P2398S	1/4 -20	1/8 3.2	3/8 x 2	1 21/32 42.1	109 49.4	800 362.9
P2401S	3/8 -16	3/16 4.8	1/2 x 2	1 11/16 42.9	156 70.8	1,300 589.7
P2403S	1/2 -13	1/4 6.4	1/2 x 2	1 11/16 42.9	201 91.2	1,900 861.8

For beams between 3/4" (19.1) to 1 1/8" (41.3) thick flanges.







**UNISTRUT®**

# PIPE/CONDUIT SUPPORTS



Pipe/Conduit Clamps .....	139
Unicushion® .....	144
Pipe & Tubing (Cush-A-Clamp®) Clamps .....	146
Pipe Hangers .....	149
Pipe Rollers .....	150
Pipe Brackets .....	153
Reference Tables .....	154

## MATERIAL

Unistrut pipe clamps, unless noted, are punch-press made from hot-rolled, pickled and oiled steel plates, strip or coil, and conform to ASTM specifications A1008, A575, A576, A635, or A36. The fitting steel also meets the physical requirements of ASTM A1011 SS GR 33. The pickling of the steel produces a smooth surface free from scale.

Many items are also available in stainless steel. Consult factory for ordering information.

## FINISHES

Pipe supports are available in:

- Electro-galvanized (EG), conforming to ASTM B633 Type III SC1
- Hot-dipped galvanized (HG), conforming to ASTM A123 or A153 (hardware)
- Perma-Green II (GR), and plain (PL).

## APPLICATION

Unistrut pipe clamps, pipe hangers, brackets and rollers are designed for the support of electrical and mechanical services. Supports to meet nearly every requirement can be attained using Unistrut Metal Framing components.

## DIMENSIONS

Imperial dimensions are illustrated in inches. Metric dimensions are shown in parenthesis or as noted. Unless noted, all metric dimensions are in millimeters and rounded to one decimal place.

## DESIGN BOLT TORQUE

BOLT SIZE	1/4"	5/16"	3/8"	1/2"	5/8"	3/4"
FOOT LBS.	6	11	19	50	100	125
N·m	8	15	25	70	135	170

Note: When tightening 1/4" screws used with a two piece pipe clamp, a torque of 5 foot pounds (60 inch-pounds) should be used.

## DESIGN LOAD

Design load data, where shown, is based on the ultimate strength of the connection with a safety factor of 5.0, unless otherwise noted.

### Pipe Clamps In Special Materials (P1109, P1211, P1425, P2024 Series)

Material	Add Suffix to P/N	Example
Steel Strap, Everdur Hardware	E	P1109 E
Copper Coated Steel Strap & Hardware	CC	P1109 CC
Aluminum	AL	P1109 AL
Stainless Steel 304 or 316	SS or ST	P1109 SS
Plastic Coated Steel Straps	PC	P1109 PC