

Maestro sensor switch

The Lutron Maestro occupancy sensor switch combines a Maestro switch with a passive infrared occupancy or vacancy sensor. The sensor detects the heat from occupants moving within an area to determine whether the space is occupied. Based on the feedback from the sensor, the occupancy sensor switch will adjust the load accordingly.

Features

- Passive infrared sensors with exclusive Lutron XCT Technology for fine motion detection
- 180° sensor field-of-view
- Up to 30 ft x 30 ft (9 m x 9 m) [900 ft² (81 m²)] major motion coverage and 20 ft x 20 ft (6 m x 6 m) [400 ft² (36 m²)] minor motion coverage
- Occupancy version can be set to Auto-ON/Auto-OFF or Manual-ON/Auto-OFF
- Vacancy version available to meet CA Title 24 requirements
- Adjustable timeout (1, 5, 15, or 30 minutes) and high/low sensitivity adjustment
- Load types: incandescent, halogen, ELV, MLV, CFL, LED, magnetic fluorescent, electronic fluorescent, and fan.



- | | |
|----------------|---------------|
| MS-OPS2 | MS-VPS2 |
| MS-OPS2H-XX-C | MS-VPS5M |
| MS-OPS5M | MS-VPS6M2-DV |
| MS-OPS5MH-XX-C | UMS-VPS6M2-DV |
| MS-OPS6M2-DV | |
| UMS-OPS6M2-DV | |

Note: "XX" in model number represents color/finish code.

Models available

- MS-OPS2-XX¹
- MS-OPS2H-XX-C²
- MS-OPS5M-XX³
- MS-OPS5MH-XX-C²
- MS-OPS6M2-DV-XX
- UMS-OPS6M2-DV-XX⁴
- MS-VPS2-XX¹
- MS-VPS5M-XX³
- MS-VPS6M2-DV-XX
- UMS-VPS6M2-DV-XX⁴

¹ For clamshell packaging, add an "H" after the "2". Available in AL, IV, LA, and WH.

² Clamshell packaged product for Canada. Available in AL, IV, LA, and WH.

³ For clamshell packaging, add an "H" after the "M". Available in AL, IV, LA, and WH.

⁴ BAA-compliant model. For other BAA/TAA compliant products, please visit our website at www.lutron.com/BAA and select "download BAA product list".

Job Name:	Model Numbers:
Job Number:	

Specifications

Regulatory Approvals

- UL® Listed to U.S. and Canadian safety requirements.
- NOM Certification (MS- models only).

Power

- 120 V~ 50/60 Hz*
- 120–277 V~ 50/60 Hz*

Key Design Features

- All lighting loads
- Crush/tamper resistant lens
- Smart ambient light detection
- Adaptive switching algorithm for extended relay life
- XCT Technology for fine motion detection
- Lutron patented Softswitch

Environment

- Ambient operating temperature: 32 °F to 104 °F (0 °C to 40 °C), 0%–90% humidity, non-condensing. Indoor use only.

Warranty

- 5-Year Limited Warranty. For additional Warranty information, please visit www.lutron.com/TechnicalDocumentLibrary/Sensor_Warranty.pdf

Additional Information

- When using MS-OPS2, MS-OPS5M, MS-OPS6M2-DV, MS-VPS2, MS-VPS5M, or MS-VPS6M2-DV on GFI-controlled circuits, please see Lutron P/N 048440 on www.lutron.com
- For Maestro Occupancy sensing dimmer models, please see Lutron P/N 369270 on www.lutron.com
- For use with MA-AS, MSC-AS, MA-AS-277, or MSC-AS-277 to control the load from more than two locations, please see Lutron P/N 048435 on www.lutron.com
- For more information, please see www.lutron.com/occvacensors
- Lutron Customer Assistance: 1.844.LUTRON1

* Maximum current ratings for individual models are provided in the **Selection Matrix** on page 4.

Advanced Features

Switching

- Standard zero cross—maximizes relay life by switching at the point of minimum energy on the AC power curve
- Adaptive zero cross—maximizes relay life by switching at the point of minimum energy on the AC power curve. Actively adapts to variations in relay timing
- Lutron Patented Softswitch circuit—eliminates arcing at mechanical contacts when loads are switched. Extends relay life to an average of 1,000,000 cycles (on/off) for resistive, capacitive, or inductive sources

XCT Technology

Advanced sensing technology for fine motion detection ensures that the lights stay on while the room is occupied, and that the sensor does not turn on falsely when there is no occupancy in the room. For more information, see www.lutron.com/TechnicalDocumentLibrary/white%20paper%20XCT%204-23-09%20B.pdf

<p>Job Name:</p> <p>Job Number:</p>	<p>Model Numbers:</p>
------------------------------------------------------	------------------------------

Custom Settings

Ambient Light Detection

Lights turn on only if natural light in room is low.

- Smart—Ambient light threshold adjusts precisely to the user’s preference.

Instructions: If switch turns on when there is enough natural light, or if switch does not turn on when there is not enough natural light, press the large button within 5 seconds of entering the room. Over time, this interaction will “teach” the switch your preferred setting.

Sensor Operation

- Occupancy/Vacancy: Auto-ON / Auto-OFF or Manual-ON / Auto-OFF
- Vacancy only: Manual-ON / Auto-OFF only

Timeout Options

(See **Additional Features** on page 5 for default settings)

- 1 Minute
- 5 Minutes
- 15 Minutes
- 30 Minutes

Sensitivity Options

- High sensitivity (default)
- Low sensitivity

Auto-ON Options

(MS-OPS and UMS-OPS only)

- Occupancy (default): Auto-ON/Auto-OFF
- Vacancy*: Manual-ON/Auto-OFF
- Low Light: Lights turn on only if needed (if ambient light is below threshold)

* There is a 15-second grace period that begins when the lights are automatically turned off, during which the lights will automatically turn back on in response to motion. This grace period is provided as a safety and convenience feature in the event that the lights turn off while the room is still occupied, so that the user does not need to manually turn the lights back on. After 15 seconds, the grace period expires and the lights must be manually turned on.

Manual Off-While-Occupied Options

(MS-OPS and UMS-OPS only — see **Additional Features** on page 5 for default setting)

- Enabled
 - When the occupancy sensor switch is manually turned off, the occupancy sensor switch will not turn the lights back on automatically while the room is occupied.
 - Once the room is vacated, the Auto-ON feature returns to normal operation after the timeout period has expired.
 - This may be the preference in conference rooms or classrooms while viewing presentations. This feature requires motion to keep the lights off.
- Disabled
 - When the occupancy sensor switch is manually turned off, the Auto-ON feature will return to normal operation after 25 seconds.
 - This may be the preference if the user always wants the lights to turn on upon entering and the lights to turn off when the room is vacant.

Job Name:	Model Numbers:
Job Number:	

Selection Matrix



Model Number¹

MS-OPS2-XX		✓			2 A ⁶				✓		1
MS-OPS2H-XX-C		✓			2 A ⁶				✓		1
MS-OPS5M-XX			✓	✓	5 A		3 A	3 A	✓		2, 3, 5
MS-OPS5MH-XX-C			✓	✓	5 A		3 A	3 A	✓		2, 3, 5
MS-OPS6M2-DV-XX			✓	✓		6 A	3 A	3 A	✓		2-6
UMS-OPS6M2-DV-XX ⁵			✓	✓		6 A	3 A	3 A	✓		2-6
MS-VPS2-XX	✓	✓			2 A ⁶				✓		1
MS-VPS5M-XX	✓		✓	✓	5 A		3 A	3 A	✓		2, 3, 5
MS-VPS6M2-DV-XX	✓		✓	✓		6 A	3 A	3 A	✓		2-6
UMS-VPS6M2-DV-XX ⁵	✓		✓	✓		6 A	3 A	3 A	✓		2-6

- ¹ XX in model number represents color/finish code.
 - ² Occupancy sensors can be configured as Auto-ON/Auto-OFF or Manual-ON/Auto-OFF. Vacancy sensors are configured as Manual-ON/Auto-OFF only.
 - ³ Standard mechanical 3-way switch cannot be combined with companion switch.
 - ⁴ Companion switch MA-AS, MSC-AS, MA-AS-277, or MSC-AS-277 is required for multi-location installations (more than two locations controlling the same lighting circuit). Up to nine companion switches may be connected.
 - ⁵ BAA-compliant model. For other BAA/TAA compliant products, please visit our website at www.lutron.com/BAA and select "download BAA product list".
 - ⁶ 150 W LED, 200 W MLV, 250 W Incandescent/Halogen/ELV, 2 A Ballast.
- * **Note:** Neutral is optional only for retrofit or replacement applications when ground connection is available. Connect green-sleeve wire to ground when a neutral connection is not available. When a neutral connection is available, remove the green sleeve and connect the white wire to neutral. Please note that a ground or neutral wire is required for product to function. If neither wire is present, consult a licensed electrician.

Job Name:	Model Numbers:
Job Number:	

Additional Features



Model Number ¹						
MS-OPS2-XX	✓	Smart	Adaptive	✓	Disabled	5
MS-OPS2H-XX-C	✓	Smart	Adaptive	✓	Disabled	5
MS-OPS5M-XX	✓	Smart	Adaptive	✓	Disabled	5
MS-OPS5MH-XX-C	✓	Smart	Adaptive	✓	Disabled	5
MS-OPS6M2-DV-XX	✓	Smart	Adaptive	✓	Enabled	15
UMS-OPS6M2-DV-XX	✓	Smart	Adaptive	✓	Enabled	15
MS-VPS2-XX	✓	Smart	Adaptive	✓		5
MS-VPS5M-XX	✓	Smart	Adaptive	✓		5
MS-VPS6M2-DV-XX	✓	Smart	Adaptive	✓		15
UMS-VPS6M2-DV-XX	✓	Smart	Adaptive	✓		15

¹ XX in model number represents color / finish code.

Job Name: Job Number:	Model Numbers:
------------------------------	----------------

Placement and Operation

- The ability of the occupancy sensor switch to detect motion requires line-of-sight of room occupants. The occupancy sensor switch must have an unobstructed view of the room.
- Hot objects and moving air currents can affect the performance of the occupancy sensor switch.
- The performance of the occupancy sensor switch depends on a temperature differential between the ambient room temperature and that of room occupants. Warmer rooms may reduce the ability of the occupancy sensor switch to detect occupants.

Definitions

Major motion: movement of a person entering or passing through an area.

Minor motion: movement of a person occupying an area and engaging in small activities (e.g., reaching for a telephone, turning the pages of a book, opening a file folder, picking up a coffee cup).

NEMA WD7 Coverage

 Major motion coverage: 900 ft² (81 m²)

 Minor motion coverage: 400 ft² (36 m²)



Horizontal Beam Diagram



Vertical Beam Diagram



Job Name:	Model Numbers:
Job Number:	

Dimensions

Measurements shown as: in (mm).

Front View



Side View



Ganging

When ganging with other controls in the same wallbox, remove inside fins (UMS-OPS6M-DV and UMS-VPS6M-DV only).

Each control has inside fins removed



Middle of Gang control has all fins removed

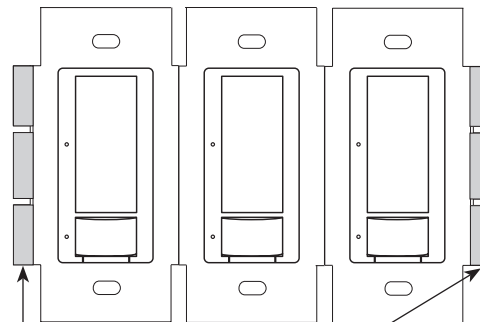

Do NOT remove outside fins on end-of-gang controls

Job Name:	Model Numbers:
Job Number:	

Mounting



Operation



- MS-OPS2
- MS-OPS5M
- MS-OPS6M2-DV
- UMS-OPS6M2-DV
- MS-VPS2
- MS-VPS5M
- MS-VPS6M2-DV
- UMS-VPS6M2-DV



*Note: Blue wire not on models: MS-OPS2, MS-VPS2.

Job Name:	Model Numbers:
Job Number:	

Wiring Diagrams

Wiring Diagram 1- with Neutral

Single Location Installation (120 V~)
-OPS2 and -VPS2



Note: When a neutral connection is available, remove the green sleeve and connect the white wire to neutral.

Wiring Diagram 1- without Neutral

Single Location Installation (120 V~)
-OPS2 and -VPS2



Note: Connect green-sleeved wire to ground only in retrofit and replacement applications.

Wiring Diagram 2 - with Neutral

Single Location Installation (120 V~)¹
-OPS5M, -OPS6M2-DV, -VPS5M, -VPS6M2-DV



Note: When a neutral connection is available, remove the green sleeve and connect the white wire to neutral.

Wiring Diagram 2 - without Neutral

Single Location Installation (120 V~)¹
-OPS5M, -OPS6M2-DV, -VPS5M, -VPS6M2-DV



Note: Connect green-sleeved wire to ground only in retrofit and replacement applications.

- ¹ When using controls in single location installations, tighten the blue terminal or cap blue wire. Do not connect the blue terminal/wire to any other wire or to ground.
- ² Only one occupancy sensor switch can be used per multi-location circuit.
- ³ A single standard mechanical 3-way switch or up to 9 companion switches may be connected to most occupancy sensor switches. Standard mechanical 3-way switch cannot be combined with companion switch. Total blue terminal wire length may be up to 150 ft (46 m).

Continued on next page...

Job Name:	Model Numbers:
Job Number:	

Wiring Diagrams *(continued)*

Wiring Diagram 3 - with Neutral

3-way Installation with Standard Mechanical Switch (120 V~)^{2, 3}

-OPS5M, -OPS6M2-DV, -VPS5M, -VPS6M2-DV



OR

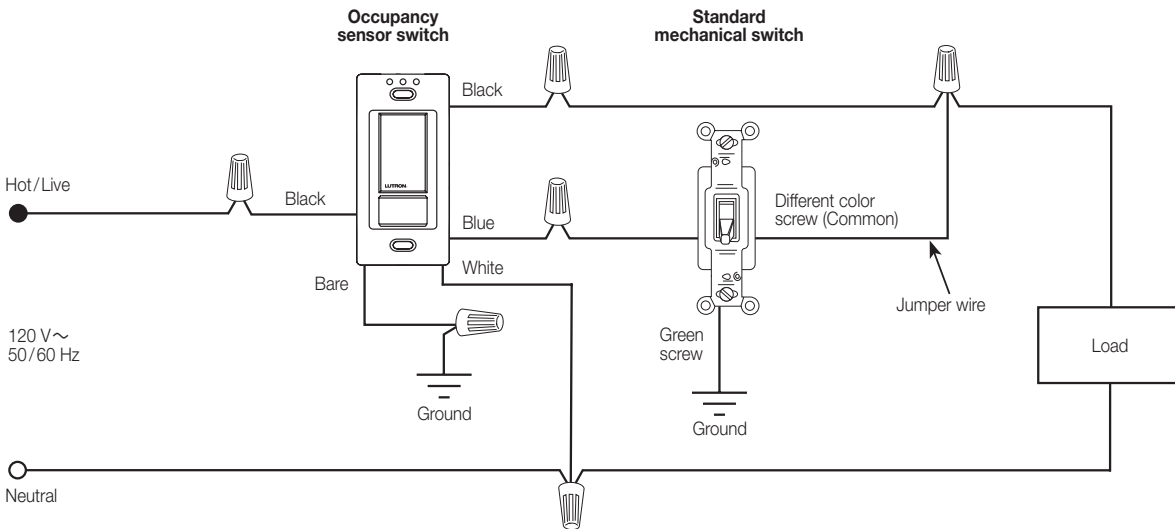

Note: When a neutral connection is available, remove the green sleeve and connect the white wire to neutral.

- ¹ When using controls in single location installations, tighten the blue terminal or cap blue wire. Do not connect the blue terminal/wire to any other wire or to ground.
- ² Only one occupancy sensor switch can be used per multi-location circuit.
- ³ A single standard mechanical 3-way switch or up to 9 companion switches may be connected to most occupancy sensor switches. Standard mechanical 3-way switch cannot be combined with companion switch. Total blue terminal wire length may be up to 150 ft (46 m).

Continued on next page...

Job Name:	Model Numbers:
Job Number:	

Wiring Diagrams *(continued)*

Wiring Diagram 3 - without Neutral
 3-way Installation with Standard Mechanical Switch (120 V~)^{2, 3}
 -OPS5M, -OPS6M2-DV, -VPS5M, -VPS6M2-DV



OR



Note: Connect green-sleeved wire to ground only in retrofit and replacement applications.

- ¹ When using controls in single location installations, tighten the blue terminal or cap blue wire. Do not connect the blue terminal/wire to any other wire or to ground.
- ² Only one occupancy sensor switch can be used per multi-location circuit.
- ³ A single standard mechanical 3-way switch or up to 9 companion switches may be connected to most occupancy sensor switches. Standard mechanical 3-way switch cannot be combined with companion switch. Total blue terminal wire length may be up to 150 ft (46 m).

Continued on next page...

Job Name:	Model Numbers:
Job Number:	

Wiring Diagrams (continued)

Wiring Diagram 4 - with Neutral

3-way Installation with Standard Mechanical Switch (277 V~)^{1, 2, 3}
 -OPS6M2-DV, -VPS6M2-DV



OR



Note: When a neutral connection is available, remove the green sleeve and connect the white wire to neutral.

- ¹ A single standard mechanical 3-way switch or up to 9 companion switches may be connected to most occupancy sensor switches. Standard mechanical 3-way switch cannot be combined with companion switch. Total blue terminal wire length may be up to 150 ft (46 m).
- ² Only one occupancy sensor switch can be used per multi-location circuit.
- ³ Fan load applies to 120 V~ only (not for 277 V~).
- ⁴ Occupancy sensor switch can be installed in any location.

Continued on next page...

Job Name:	Model Numbers:
Job Number:	

Wiring Diagrams (continued)

Wiring Diagram 4 - without Neutral

3-way Installation with Standard Mechanical Switch (277 V~)^{1, 2, 3}
-OPS6M2-DV, -VPS6M2-DV

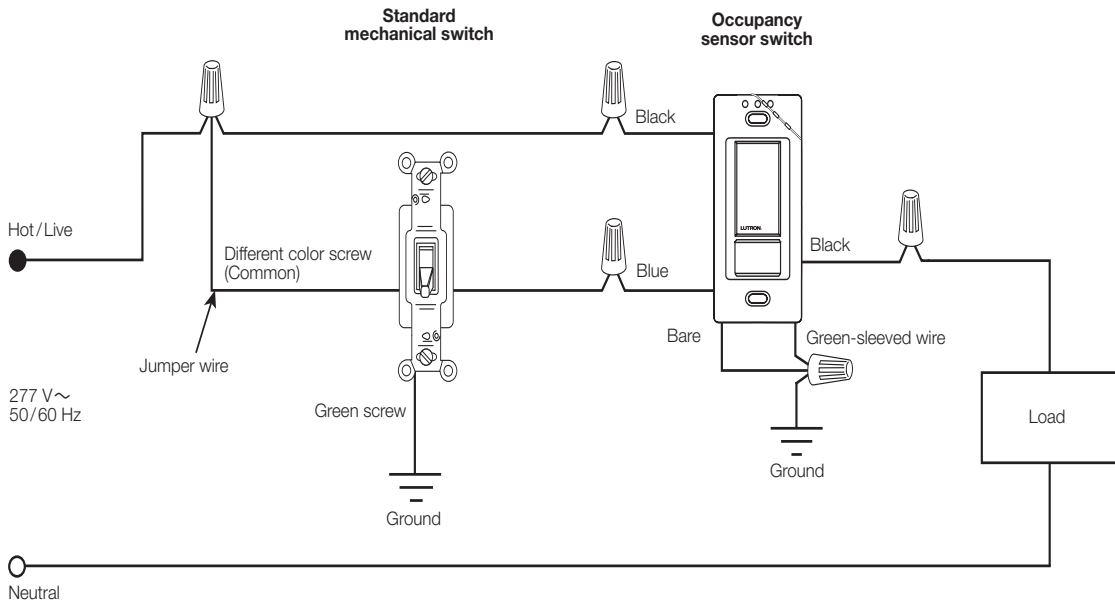

OR

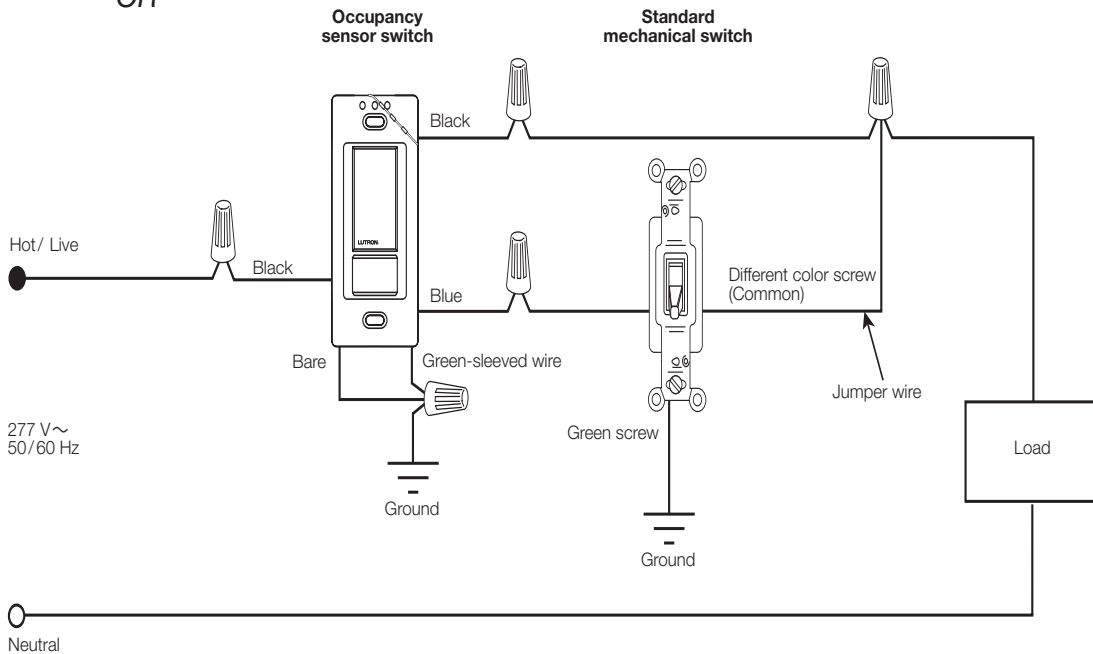

Note: Connect green-sleeved wire to ground only in retrofit and replacement applications.

- ¹ A single standard mechanical 3-way switch or up to 9 companion switches may be connected to most occupancy sensor switches. Standard mechanical 3-way switch cannot be combined with companion switch. Total blue terminal wire length may be up to 150 ft (46 m).
- ² Only one occupancy sensor switch can be used per multi-location circuit.
- ³ Fan load applies to 120 V~ only (not for 277 V~).
- ⁴ Occupancy sensor switch can be installed in any location.

Continued on next page...

Job Name:	Model Numbers:
Job Number:	

Wiring Diagrams *(continued)*

Wiring Diagram 5 - with Neutral

Multi-Location Installation (120 V~)^{1, 2, 4}

-OPS5M, -OPS6M2-DV, -VPS5M, -VPS6M2-DV with MA-AS or MSC-AS

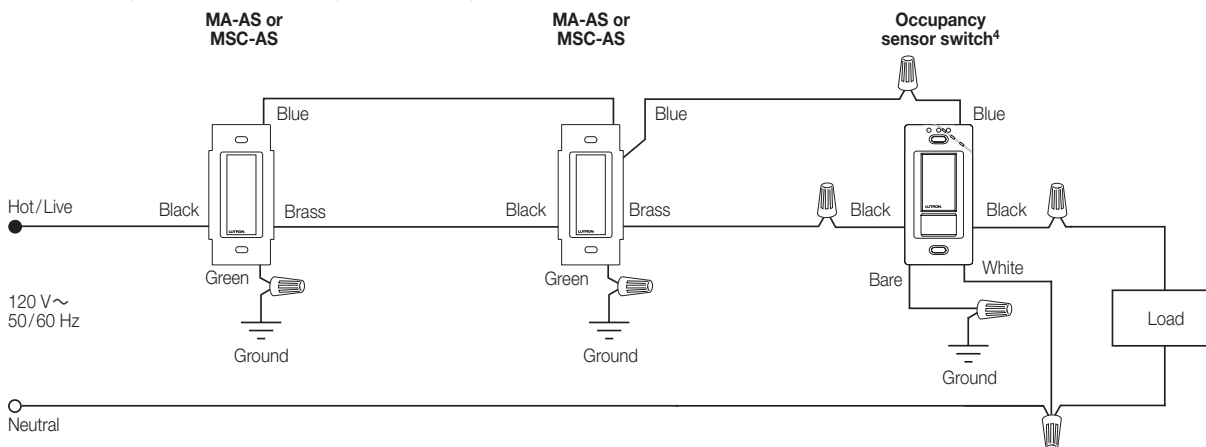

Note: When a neutral connection is available, remove the green sleeve and connect the white wire to neutral.

Wiring Diagram 5 - without Neutral

Multi-Location Installation (120 V~)^{1, 2, 4}

-OPS5M, -OPS6M2-DV, -VPS5M, -VPS6M2-DV with MA-AS or MSC-AS

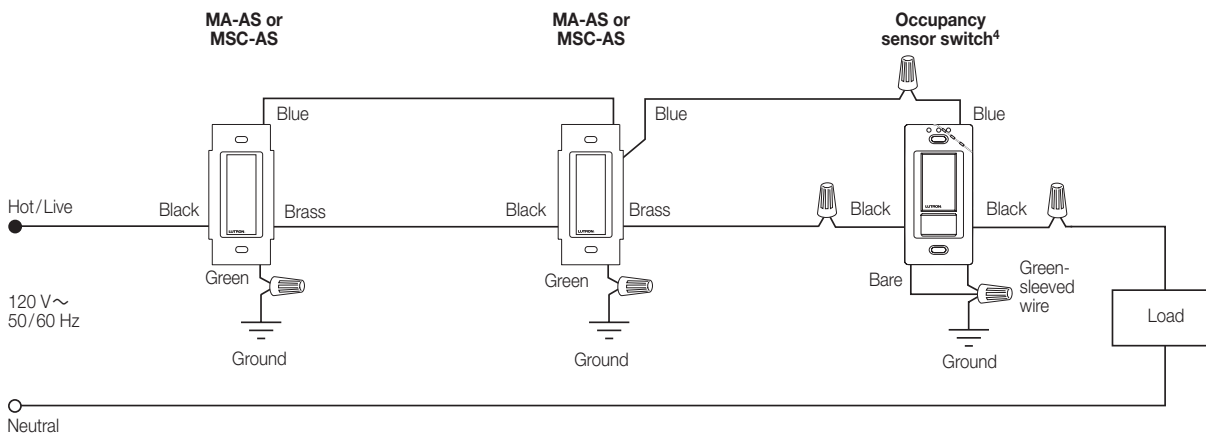

Note: Connect green-sleeved wire to ground only in retrofit and replacement applications.

- ¹ A single standard mechanical 3-way switch or up to 9 companion switches may be connected to most occupancy sensor switches. Standard mechanical 3-way switch cannot be combined with companion switch. Total blue terminal wire length may be up to 150 ft (46 m).
- ² Only one occupancy sensor switch can be used per multi-location circuit.
- ³ Fan load applies to 120 V~ only (not for 277 V~).
- ⁴ Occupancy sensor switch can be installed in any location.

Continued on next page...

Job Name:	Model Numbers:
Job Number:	

Wiring Diagrams *(continued)*

Wiring Diagram 6 - with Neutral

Multi-Location Installation (277 V~)^{1, 2, 3, 4}

-OPS6M2-DV, -VPS6M2-DV with MA-AS-277 or MSC-AS-277



Note: When a neutral connection is available, remove the green sleeve and connect the white wire to neutral.

Wiring Diagram 6 - without Neutral

Multi-Location Installation (277 V~)^{1, 2, 3, 4}

-OPS6M2-DV, -VPS6M2-DV with MA-AS-277 or MSC-AS-277

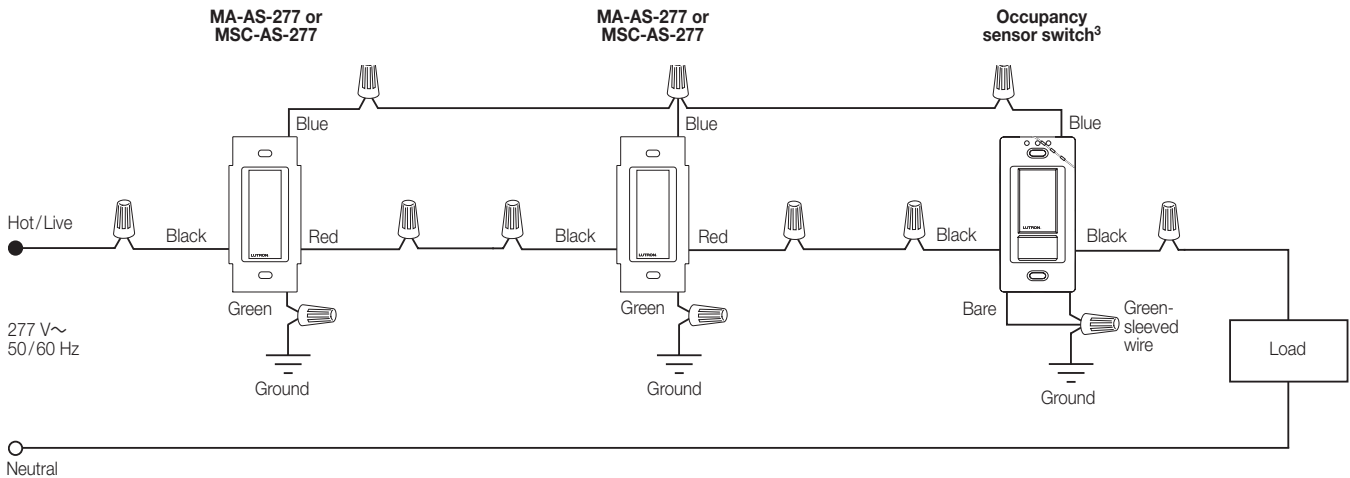

Note: Connect green-sleeved wire to ground only in retrofit and replacement applications.

- ¹ A single standard mechanical 3-way switch or up to 9 companion switches may be connected to most occupancy sensor switches. Standard mechanical 3-way switch cannot be combined with companion switch. Total blue terminal wire length may be up to 150 ft (46 m).
- ² Only one occupancy sensor switch can be used per multi-location circuit.
- ³ Fan load applies to 120 V~ only (not for 277 V~).
- ⁴ Occupancy sensor switch can be installed in any location.

Continued on next page...

Job Name:	Model Numbers:
Job Number:	

Colors and Finishes

Gloss Finishes



White
WH



Ivory
IV



Almond
AL



Light Almond
LA



Gray
GR



Brown
BR



Black
BL

Satin Finishes



Snow
SW



Midnight
MN



Taupe
TP



Biscuit
BI



Palladium
PD



Hot
HT

For the latest color offerings
please see our website:
<http://www.lutron.com/satincolors>

- Due to printing limitations, colors and finishes shown cannot be guaranteed to match actual product colors perfectly.
- Color chip keychains are available for more precise color matching:
Gloss Finishes: DG-CK-1
Satin Finishes: SF-CK-1

The Lutron logo, Lutron, Maestro, FASS, XCT, and Softswitch are trademarks or registered trademarks of Lutron Electronics Co., Inc. in the US and/or other countries. All other product names, logos, and brands are property of their respective owners.

Job Name:	Model Numbers:
Job Number:	

Maestro sensor switch

The Lutron Maestro occupancy sensor switch combines a Maestro switch with a passive infrared occupancy or vacancy sensor. The sensor detects the heat from occupants moving within an area to determine whether the space is occupied. Based on the feedback from the sensor, the occupancy sensor switch will adjust the load accordingly.

Features

- Passive infrared sensors with exclusive Lutron XCT Technology for fine motion detection
- 180° sensor field-of-view
- Up to 30 ft x 30 ft (9 m x 9 m) [900 ft² (81 m²)] major motion coverage and 20 ft x 20 ft (6 m x 6 m) [400 ft² (36 m²)] minor motion coverage
- Occupancy version can be set to Auto-ON/Auto-OFF or Manual-ON/Auto-OFF
- Vacancy version available to meet CA Title 24 requirements
- Adjustable timeout (1, 5, 15, or 30 minutes) and high/low sensitivity adjustment
- Load types: incandescent, halogen, ELV, MLV, CFL, LED, magnetic fluorescent, electronic fluorescent, and fan.



- | | |
|----------------|---------------|
| MS-OPS2 | MS-VPS2 |
| MS-OPS2H-XX-C | MS-VPS5M |
| MS-OPS5M | MS-VPS6M2-DV |
| MS-OPS5MH-XX-C | UMS-VPS6M2-DV |
| MS-OPS6M2-DV | |
| UMS-OPS6M2-DV | |

Note: "XX" in model number represents color/finish code.

Models available

- MS-OPS2-XX¹
- MS-OPS2H-XX-C²
- MS-OPS5M-XX³
- MS-OPS5MH-XX-C²
- MS-OPS6M2-DV-XX
- UMS-OPS6M2-DV-XX⁴
- MS-VPS2-XX¹
- MS-VPS5M-XX³
- MS-VPS6M2-DV-XX
- UMS-VPS6M2-DV-XX⁴

¹ For clamshell packaging, add an "H" after the "2". Available in AL, IV, LA, and WH.

² Clamshell packaged product for Canada. Available in AL, IV, LA, and WH.

³ For clamshell packaging, add an "H" after the "M". Available in AL, IV, LA, and WH.

⁴ BAA-compliant model. For other BAA/TAA compliant products, please visit our website at www.lutron.com/BAA and select "download BAA product list".

Job Name:	Model Numbers:
Job Number:	

Specifications

Regulatory Approvals

- UL® Listed to U.S. and Canadian safety requirements.
- NOM Certification (MS- models only).

Power

- 120 V~ 50/60 Hz*
- 120–277 V~ 50/60 Hz*

Key Design Features

- All lighting loads
- Crush/tamper resistant lens
- Smart ambient light detection
- Adaptive switching algorithm for extended relay life
- XCT Technology for fine motion detection
- Lutron patented Softswitch

Environment

- Ambient operating temperature: 32 °F to 104 °F (0 °C to 40 °C), 0%–90% humidity, non-condensing. Indoor use only.

Warranty

- 5-Year Limited Warranty. For additional Warranty information, please visit www.lutron.com/TechnicalDocumentLibrary/Sensor_Warranty.pdf

Additional Information

- When using MS-OPS2, MS-OPS5M, MS-OPS6M2-DV, MS-VPS2, MS-VPS5M, or MS-VPS6M2-DV on GFI-controlled circuits, please see Lutron P/N 048440 on www.lutron.com
- For Maestro Occupancy sensing dimmer models, please see Lutron P/N 369270 on www.lutron.com
- For use with MA-AS, MSC-AS, MA-AS-277, or MSC-AS-277 to control the load from more than two locations, please see Lutron P/N 048435 on www.lutron.com
- For more information, please see www.lutron.com/occvacensors
- Lutron Customer Assistance: 1.844.LUTRON1

* Maximum current ratings for individual models are provided in the **Selection Matrix** on page 4.

Advanced Features

Switching

- Standard zero cross—maximizes relay life by switching at the point of minimum energy on the AC power curve
- Adaptive zero cross—maximizes relay life by switching at the point of minimum energy on the AC power curve. Actively adapts to variations in relay timing
- Lutron Patented Softswitch circuit—eliminates arcing at mechanical contacts when loads are switched. Extends relay life to an average of 1,000,000 cycles (on/off) for resistive, capacitive, or inductive sources

XCT Technology

Advanced sensing technology for fine motion detection ensures that the lights stay on while the room is occupied, and that the sensor does not turn on falsely when there is no occupancy in the room. For more information, see www.lutron.com/TechnicalDocumentLibrary/white%20paper%20XCT%204-23-09%20B.pdf

<p>Job Name:</p> <p>Job Number:</p>	<p>Model Numbers:</p>
------------------------------------------------------	------------------------------

Custom Settings

Ambient Light Detection

Lights turn on only if natural light in room is low.

- Smart—Ambient light threshold adjusts precisely to the user’s preference.

Instructions: If switch turns on when there is enough natural light, or if switch does not turn on when there is not enough natural light, press the large button within 5 seconds of entering the room. Over time, this interaction will “teach” the switch your preferred setting.

Sensor Operation

- Occupancy/Vacancy: Auto-ON / Auto-OFF or Manual-ON / Auto-OFF
- Vacancy only: Manual-ON / Auto-OFF only

Timeout Options

(See **Additional Features** on page 5 for default settings)

- 1 Minute
- 5 Minutes
- 15 Minutes
- 30 Minutes

Sensitivity Options

- High sensitivity (default)
- Low sensitivity

Auto-ON Options

(MS-OPS and UMS-OPS only)

- Occupancy (default): Auto-ON/Auto-OFF
- Vacancy*: Manual-ON/Auto-OFF
- Low Light: Lights turn on only if needed (if ambient light is below threshold)

* There is a 15-second grace period that begins when the lights are automatically turned off, during which the lights will automatically turn back on in response to motion. This grace period is provided as a safety and convenience feature in the event that the lights turn off while the room is still occupied, so that the user does not need to manually turn the lights back on. After 15 seconds, the grace period expires and the lights must be manually turned on.

Manual Off-While-Occupied Options

(MS-OPS and UMS-OPS only — see **Additional Features** on page 5 for default setting)

- Enabled
 - When the occupancy sensor switch is manually turned off, the occupancy sensor switch will not turn the lights back on automatically while the room is occupied.
 - Once the room is vacated, the Auto-ON feature returns to normal operation after the timeout period has expired.
 - This may be the preference in conference rooms or classrooms while viewing presentations. This feature requires motion to keep the lights off.
- Disabled
 - When the occupancy sensor switch is manually turned off, the Auto-ON feature will return to normal operation after 25 seconds.
 - This may be the preference if the user always wants the lights to turn on upon entering and the lights to turn off when the room is vacant.

<p>Job Name:</p> <p>Job Number:</p>	<p>Model Numbers:</p>
------------------------------------------------------	------------------------------

Selection Matrix



Model Number¹

MS-OPS2-XX		✓			2 A ⁶				✓		1
MS-OPS2H-XX-C		✓			2 A ⁶				✓		1
MS-OPS5M-XX			✓	✓	5 A		3 A	3 A	✓		2, 3, 5
MS-OPS5MH-XX-C			✓	✓	5 A		3 A	3 A	✓		2, 3, 5
MS-OPS6M2-DV-XX			✓	✓		6 A	3 A	3 A	✓		2-6
UMS-OPS6M2-DV-XX ⁵			✓	✓		6 A	3 A	3 A	✓		2-6
MS-VPS2-XX	✓	✓			2 A ⁶				✓		1
MS-VPS5M-XX	✓		✓	✓	5 A		3 A	3 A	✓		2, 3, 5
MS-VPS6M2-DV-XX	✓		✓	✓		6 A	3 A	3 A	✓		2-6
UMS-VPS6M2-DV-XX ⁵	✓		✓	✓		6 A	3 A	3 A	✓		2-6

¹ XX in model number represents color/finish code.

² Occupancy sensors can be configured as Auto-ON/Auto-OFF or Manual-ON/Auto-OFF. Vacancy sensors are configured as Manual-ON/Auto-OFF only.

³ Standard mechanical 3-way switch cannot be combined with companion switch.

⁴ Companion switch MA-AS, MSC-AS, MA-AS-277, or MSC-AS-277 is required for multi-location installations (more than two locations controlling the same lighting circuit). Up to nine companion switches may be connected.

⁵ BAA-compliant model. For other BAA/TAA compliant products, please visit our website at www.lutron.com/BAA and select "download BAA product list".

⁶ 150 W LED, 200 W MLV, 250 W Incandescent/Halogen/ELV, 2 A Ballast.

* **Note:** Neutral is optional only for retrofit or replacement applications when ground connection is available. Connect green-sleeve wire to ground when a neutral connection is not available. When a neutral connection is available, remove the green sleeve and connect the white wire to neutral. Please note that a ground or neutral wire is required for product to function. If neither wire is present, consult a licensed electrician.

Job Name:	Model Numbers:
Job Number:	

Additional Features



Model Number ¹						
MS-OPS2-XX	✓	Smart	Adaptive	✓	Disabled	5
MS-OPS2H-XX-C	✓	Smart	Adaptive	✓	Disabled	5
MS-OPS5M-XX	✓	Smart	Adaptive	✓	Disabled	5
MS-OPS5MH-XX-C	✓	Smart	Adaptive	✓	Disabled	5
MS-OPS6M2-DV-XX	✓	Smart	Adaptive	✓	Enabled	15
UMS-OPS6M2-DV-XX	✓	Smart	Adaptive	✓	Enabled	15
MS-VPS2-XX	✓	Smart	Adaptive	✓		5
MS-VPS5M-XX	✓	Smart	Adaptive	✓		5
MS-VPS6M2-DV-XX	✓	Smart	Adaptive	✓		15
UMS-VPS6M2-DV-XX	✓	Smart	Adaptive	✓		15

¹ XX in model number represents color / finish code.

Job Name: Job Number:	Model Numbers:
------------------------------	----------------

Placement and Operation

- The ability of the occupancy sensor switch to detect motion requires line-of-sight of room occupants. The occupancy sensor switch must have an unobstructed view of the room.
- Hot objects and moving air currents can affect the performance of the occupancy sensor switch.
- The performance of the occupancy sensor switch depends on a temperature differential between the ambient room temperature and that of room occupants. Warmer rooms may reduce the ability of the occupancy sensor switch to detect occupants.

Definitions

Major motion: movement of a person entering or passing through an area.

Minor motion: movement of a person occupying an area and engaging in small activities (e.g., reaching for a telephone, turning the pages of a book, opening a file folder, picking up a coffee cup).

NEMA WD7 Coverage

 Major motion coverage: 900 ft² (81 m²)

 Minor motion coverage: 400 ft² (36 m²)



Horizontal Beam Diagram



Vertical Beam Diagram



Job Name:	Model Numbers:
Job Number:	

Dimensions

Measurements shown as: in (mm).

Front View

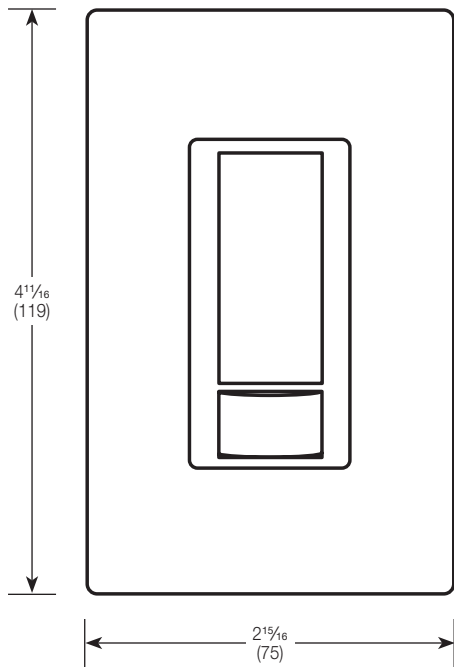

Side View

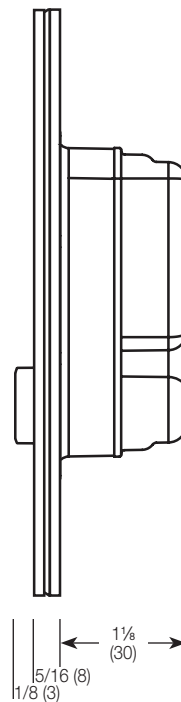

Ganging

When ganging with other controls in the same wallbox, remove inside fins (UMS-OPS6M-DV and UMS-VPS6M-DV only).

Each control has inside fins removed



Middle of Gang control has all fins removed



Do NOT remove outside fins on end-of-gang controls

Job Name:	Model Numbers:
Job Number:	

Mounting



Operation



- MS-OPS2
- MS-OPS5M
- MS-OPS6M2-DV
- UMS-OPS6M2-DV
- MS-VPS2
- MS-VPS5M
- MS-VPS6M2-DV
- UMS-VPS6M2-DV



*Note: Blue wire not on models: MS-OPS2, MS-VPS2.

Job Name:	Model Numbers:
Job Number:	

Wiring Diagrams

Wiring Diagram 1- with Neutral

Single Location Installation (120 V~)
-OPS2 and -VPS2

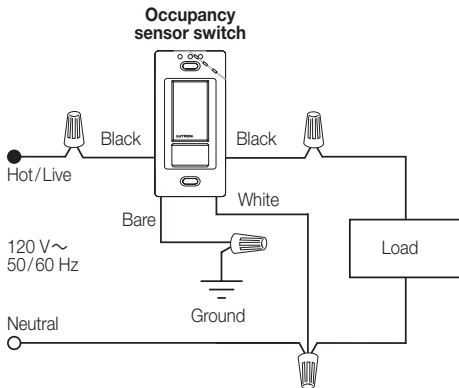

Note: When a neutral connection is available, remove the green sleeve and connect the white wire to neutral.

Wiring Diagram 1- without Neutral

Single Location Installation (120 V~)
-OPS2 and -VPS2

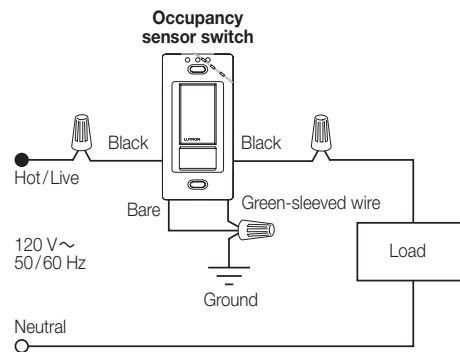

Note: Connect green-sleeved wire to ground only in retrofit and replacement applications.

Wiring Diagram 2 - with Neutral

Single Location Installation (120 V~)¹
-OPS5M, -OPS6M2-DV, -VPS5M, -VPS6M2-DV

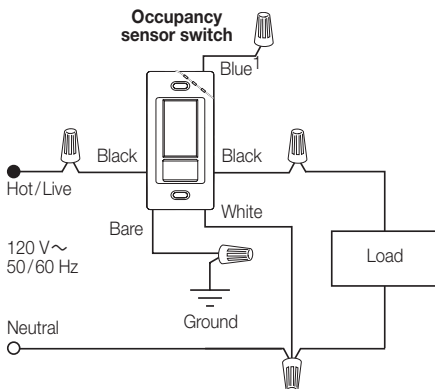

Note: When a neutral connection is available, remove the green sleeve and connect the white wire to neutral.

Wiring Diagram 2 - without Neutral

Single Location Installation (120 V~)¹
-OPS5M, -OPS6M2-DV, -VPS5M, -VPS6M2-DV

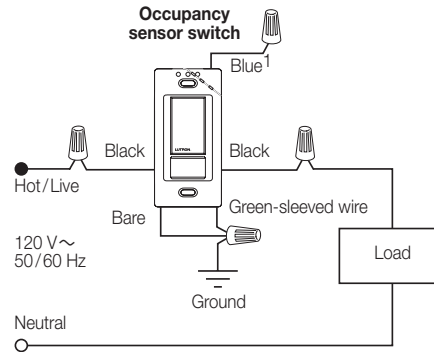

Note: Connect green-sleeved wire to ground only in retrofit and replacement applications.

- ¹ When using controls in single location installations, tighten the blue terminal or cap blue wire. Do not connect the blue terminal/wire to any other wire or to ground.
- ² Only one occupancy sensor switch can be used per multi-location circuit.
- ³ A single standard mechanical 3-way switch or up to 9 companion switches may be connected to most occupancy sensor switches. Standard mechanical 3-way switch cannot be combined with companion switch. Total blue terminal wire length may be up to 150 ft (46 m).

Continued on next page...

Job Name:	Model Numbers:
Job Number:	

Wiring Diagrams *(continued)*

Wiring Diagram 3 - with Neutral

3-way Installation with Standard Mechanical Switch (120 V~)^{2, 3}

-OPS5M, -OPS6M2-DV, -VPS5M, -VPS6M2-DV

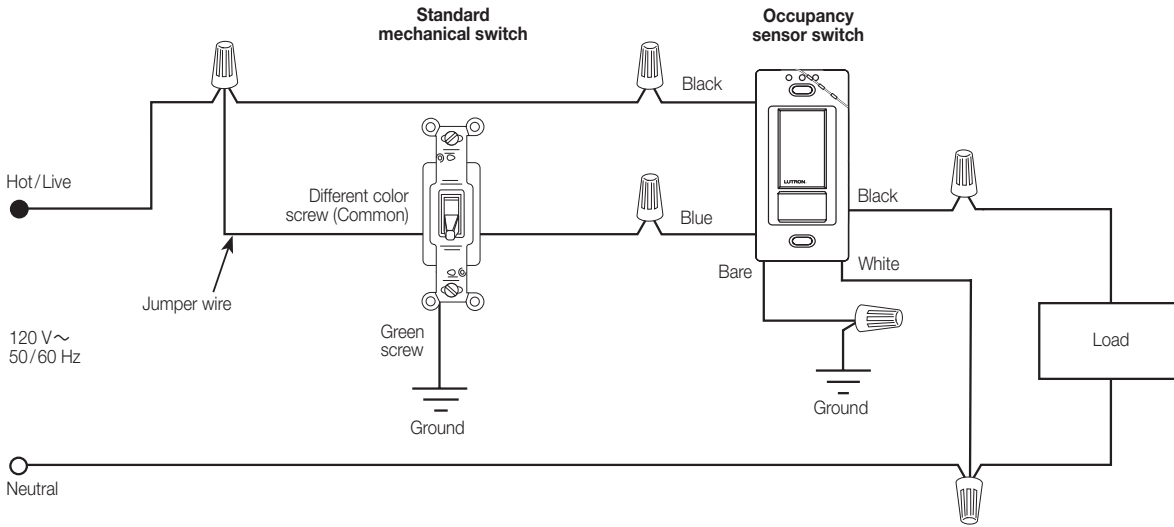

OR

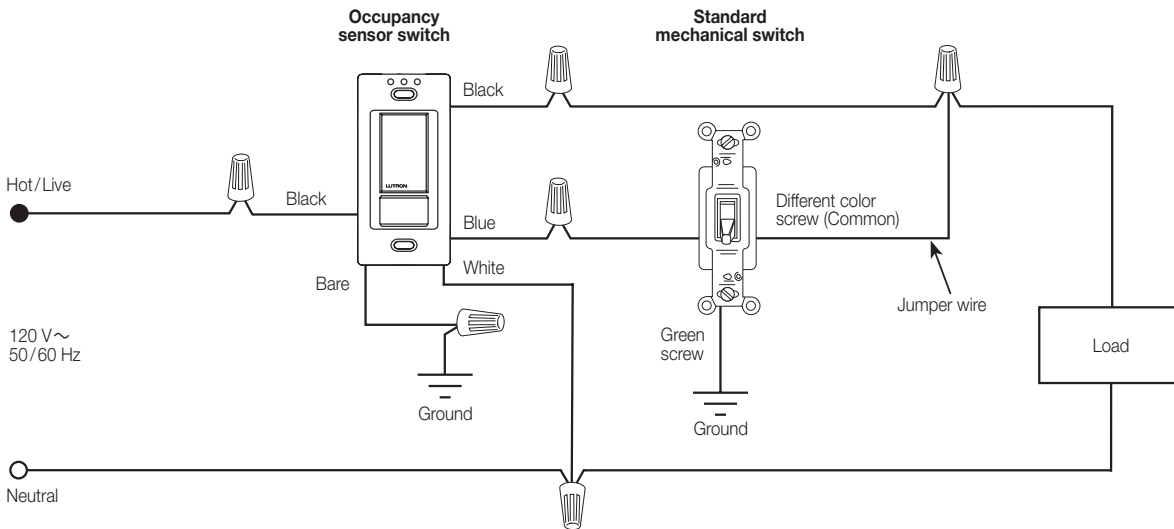

Note: When a neutral connection is available, remove the green sleeve and connect the white wire to neutral.

- ¹ When using controls in single location installations, tighten the blue terminal or cap blue wire. Do not connect the blue terminal/wire to any other wire or to ground.
- ² Only one occupancy sensor switch can be used per multi-location circuit.
- ³ A single standard mechanical 3-way switch or up to 9 companion switches may be connected to most occupancy sensor switches. Standard mechanical 3-way switch cannot be combined with companion switch. Total blue terminal wire length may be up to 150 ft (46 m).

Continued on next page...

Job Name:	Model Numbers:
Job Number:	

Wiring Diagrams *(continued)*

Wiring Diagram 3 - without Neutral
 3-way Installation with Standard Mechanical Switch (120 V~)^{2, 3}
 -OPS5M, -OPS6M2-DV, -VPS5M, -VPS6M2-DV



OR



Note: Connect green-sleeved wire to ground only in retrofit and replacement applications.

- ¹ When using controls in single location installations, tighten the blue terminal or cap blue wire. Do not connect the blue terminal/wire to any other wire or to ground.
- ² Only one occupancy sensor switch can be used per multi-location circuit.
- ³ A single standard mechanical 3-way switch or up to 9 companion switches may be connected to most occupancy sensor switches. Standard mechanical 3-way switch cannot be combined with companion switch. Total blue terminal wire length may be up to 150 ft (46 m).

Continued on next page...

Job Name:	Model Numbers:
Job Number:	

Wiring Diagrams (continued)

Wiring Diagram 4 - with Neutral

3-way Installation with Standard Mechanical Switch (277 V~)^{1, 2, 3}
 -OPS6M2-DV, -VPS6M2-DV



OR



Note: When a neutral connection is available, remove the green sleeve and connect the white wire to neutral.

- ¹ A single standard mechanical 3-way switch or up to 9 companion switches may be connected to most occupancy sensor switches. Standard mechanical 3-way switch cannot be combined with companion switch. Total blue terminal wire length may be up to 150 ft (46 m).
- ² Only one occupancy sensor switch can be used per multi-location circuit.
- ³ Fan load applies to 120 V~ only (not for 277 V~).
- ⁴ Occupancy sensor switch can be installed in any location.

Continued on next page...

Job Name:	Model Numbers:
Job Number:	

Wiring Diagrams (continued)

Wiring Diagram 4 - without Neutral

3-way Installation with Standard Mechanical Switch (277 V~)^{1, 2, 3}
-OPS6M2-DV, -VPS6M2-DV

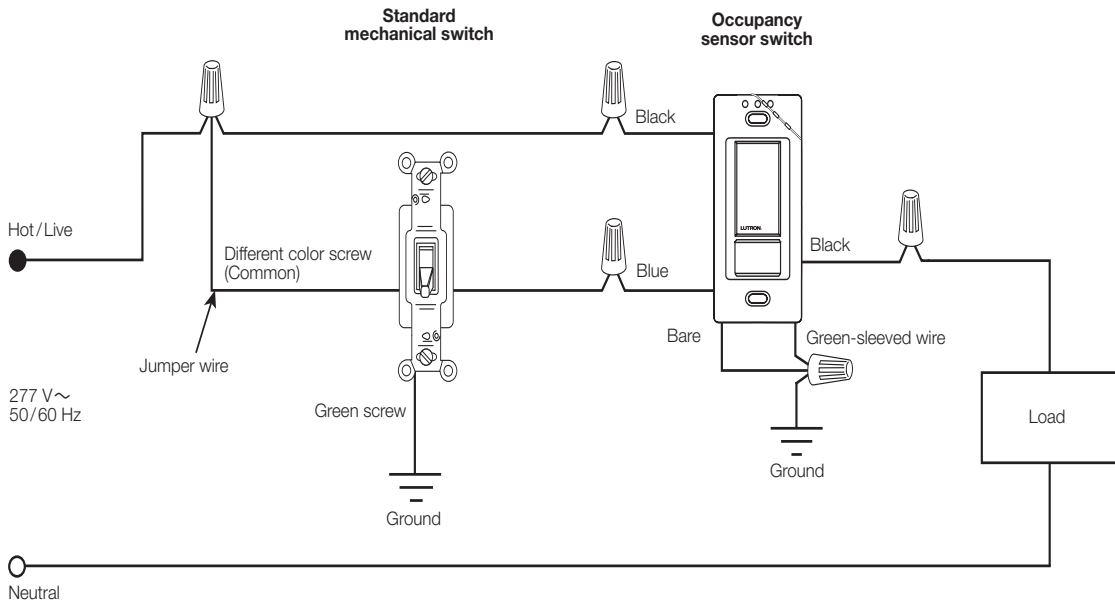

OR



Note: Connect green-sleeved wire to ground only in retrofit and replacement applications.

- ¹ A single standard mechanical 3-way switch or up to 9 companion switches may be connected to most occupancy sensor switches. Standard mechanical 3-way switch cannot be combined with companion switch. Total blue terminal wire length may be up to 150 ft (46 m).
- ² Only one occupancy sensor switch can be used per multi-location circuit.
- ³ Fan load applies to 120 V~ only (not for 277 V~).
- ⁴ Occupancy sensor switch can be installed in any location.

Continued on next page...

Job Name:	Model Numbers:
Job Number:	

Wiring Diagrams *(continued)*

Wiring Diagram 5 - with Neutral

Multi-Location Installation (120 V~)^{1, 2, 4}

-OPS5M, -OPS6M2-DV, -VPS5M, -VPS6M2-DV with MA-AS or MSC-AS



Note: When a neutral connection is available, remove the green sleeve and connect the white wire to neutral.

Wiring Diagram 5 - without Neutral

Multi-Location Installation (120 V~)^{1, 2, 4}

-OPS5M, -OPS6M2-DV, -VPS5M, -VPS6M2-DV with MA-AS or MSC-AS



Note: Connect green-sleeved wire to ground only in retrofit and replacement applications.

- ¹ A single standard mechanical 3-way switch or up to 9 companion switches may be connected to most occupancy sensor switches. Standard mechanical 3-way switch cannot be combined with companion switch. Total blue terminal wire length may be up to 150 ft (46 m).
- ² Only one occupancy sensor switch can be used per multi-location circuit.
- ³ Fan load applies to 120 V~ only (not for 277 V~).
- ⁴ Occupancy sensor switch can be installed in any location.

Continued on next page...

Job Name:	Model Numbers:
Job Number:	

Wiring Diagrams (continued)

Wiring Diagram 6 - with Neutral

Multi-Location Installation (277 V~)^{1, 2, 3, 4}

-OPS6M2-DV, -VPS6M2-DV with MA-AS-277 or MSC-AS-277



Note: When a neutral connection is available, remove the green sleeve and connect the white wire to neutral.

Wiring Diagram 6 - without Neutral

Multi-Location Installation (277 V~)^{1, 2, 3, 4}

-OPS6M2-DV, -VPS6M2-DV with MA-AS-277 or MSC-AS-277



Note: Connect green-sleeved wire to ground only in retrofit and replacement applications.

- ¹ A single standard mechanical 3-way switch or up to 9 companion switches may be connected to most occupancy sensor switches. Standard mechanical 3-way switch cannot be combined with companion switch. Total blue terminal wire length may be up to 150 ft (46 m).
- ² Only one occupancy sensor switch can be used per multi-location circuit.
- ³ Fan load applies to 120 V~ only (not for 277 V~).
- ⁴ Occupancy sensor switch can be installed in any location.

Continued on next page...

Job Name:	Model Numbers:
Job Number:	

Colors and Finishes

Gloss Finishes



White
WH



Ivory
IV



Almond
AL



Light Almond
LA



Gray
GR



Brown
BR



Black
BL

Satin Finishes



Snow
SW



Midnight
MN



Taupe
TP



Biscuit
BI



Palladium
PD



Hot
HT

For the latest color offerings
please see our website:
<http://www.lutron.com/satincolors>

- Due to printing limitations, colors and finishes shown cannot be guaranteed to match actual product colors perfectly.
- Color chip keychains are available for more precise color matching:
Gloss Finishes: DG-CK-1
Satin Finishes: SF-CK-1

The Lutron logo, Lutron, Maestro, FASS, XCT, and Softswitch are trademarks or registered trademarks of Lutron Electronics Co., Inc. in the US and/or other countries. All other product names, logos, and brands are property of their respective owners.

Job Name:	Model Numbers:
Job Number:	