



KT-LED15T8-48GC-840-D

T8 LED LAMP

DESCRIPTION

15W T8 LED | 4000K | >83 CRI | High Efficiency



LAMP TYPE: Linear
BULB TYPE: T8 LED
BASE TYPE: G13 (Medium Bi-Pin)
WATTAGE: 15W
COLOR TEMPERATURE: 4000K
COLOR RENDERING INDEX (CRI): >83
WARRANTY: 5 Years



PRODUCT FEATURES

- Replacement for Conventional Fluorescent Lamp
- 50,000+ Hour Lifetime
- Approximately 40% More Energy Efficient than Standard F32T8 Lamps
- Environmentally Friendly: No Mercury Used
- Instant Startup
- Frosted Lens Eliminates Pixelation
- UL Classified; Listed on DLC Qualified Product List
- Operating Temperature: -20°C/-4°F to 45°C/113°F
- Integral Driver (Isolated), Eliminates the Need for External Driver or Ballast
- 110+ Lumens per Watt
- Improved Lamp Durability with Shatterproof Coated Glass
- ETL Sanitation Listed NSF/ANSI Standard 2 - Food Equipment

OPERATING SPECIFICATIONS

ELECTRICAL CHARACTERISTICS

Input Voltage	Power Consumption	Power Factor	Input Current
120-277Vac	15W	>0.9	0.16A @ 120V 0.07A @ 277V

PHOTOMETRIC CHARACTERISTICS

Color Temperature (CCT)	4000K
Luminous Flux	1850 lm
Color Rendering Index (CRI)	>83
Efficacy	121 lm/W
Beam Angle	240°
Visible Light Area	325°

RATED LIFE

L70 (Hours)	50,000
-------------	--------

SPECTRAL DISTRIBUTION

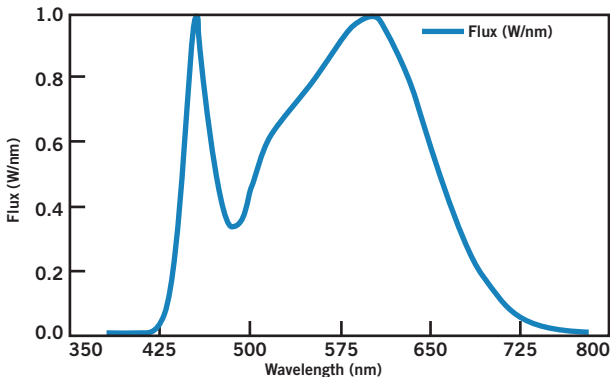

POLAR CANDELA DISTRIBUTION

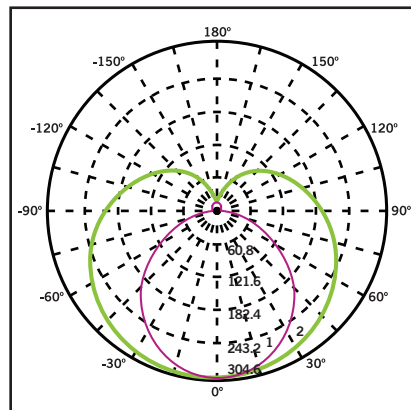

Maximum Candela = 1248.55
Located at Horizontal Angle = 0,
Vertical Angle 0

1. Violet Vertical Plane through Horizontal Angles (90-270)
2. Green Vertical Plane through Horizontal Angles (0-180)



KT-LED15T8-48GC-840-D

T8 LED LAMP

WIRING DIAGRAMS

1. Cut all existing connections to ballast as shown below and remove ballast.

Typical Ballast Configurations:



2. Re-wire fixture as shown below.

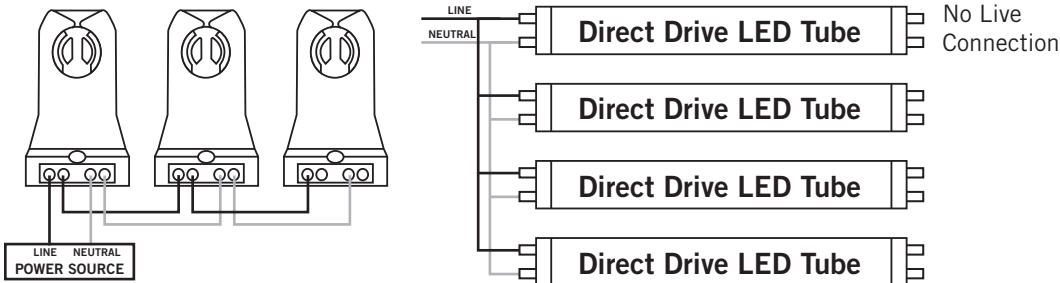

Typical Non-Shunted Lampholder

Connect wires directly to these terminals

CAUTION: Use only non-shunted lampholders.

Do not install product in a fixture with shunted lampholders (found in all fixtures using instant start ballasts). If the current lampholders are shunted, remove them and replace them with non-shunted lampholders. Make new connections directly to terminals as indicated above.

Keystone can provide any style replacement lampholders.
Call us at 800-464-2680.

PHYSICAL CHARACTERISTICS

LAMP DIMENSIONS

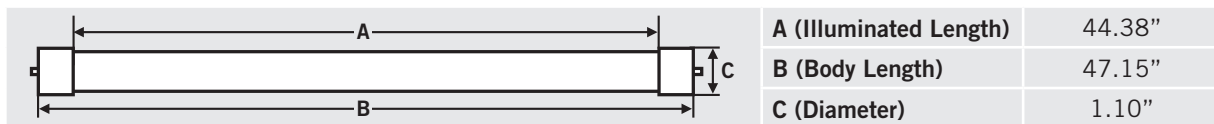

NOMINAL LENGTH: 48" BASE TYPE: G13 (Medium Bi-Pin)

ORDERING INFORMATION

ORDER CODE	PACKAGING STYLE	PACK QTY.	ITEM STATUS
KT-LED15T8-48GC-840-D /G3-CP	Carton Pack (Egg Crate Packaging)	25	Quick Ship
KT-LED15T8-48GC-840-D /G3-DP	Distributor Pack (Individual Cartons)	12	Quick Ship

CATALOG NUMBER BREAKDOWN

KT-LED15T8-48GC-840-D /G3-CP

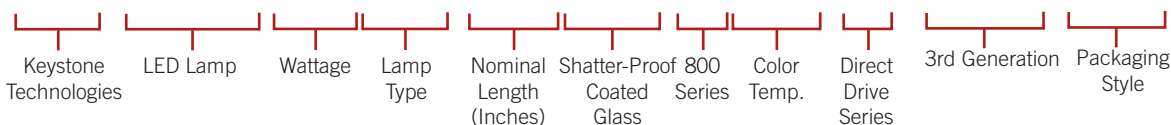



KT-LED15T8-48GC-840-D

T8 LED LAMP

DESCRIPTION

15W T8 LED | 4000K | >83 CRI | High Efficiency



LAMP TYPE: Linear
BULB TYPE: T8 LED
BASE TYPE: G13 (Medium Bi-Pin)
WATTAGE: 15W
COLOR TEMPERATURE: 4000K
COLOR RENDERING INDEX (CRI): >83
WARRANTY: 5 Years



PRODUCT FEATURES

- Replacement for Conventional Fluorescent Lamp
- 50,000+ Hour Lifetime
- Approximately 40% More Energy Efficient than Standard F32T8 Lamps
- Environmentally Friendly: No Mercury Used
- Instant Startup
- Frosted Lens Eliminates Pixelation
- UL Classified; Listed on DLC Qualified Product List
- Operating Temperature: -20°C/-4°F to 45°C/113°F
- Integral Driver (Isolated), Eliminates the Need for External Driver or Ballast
- 110+ Lumens per Watt
- Improved Lamp Durability with Shatterproof Coated Glass
- ETL Sanitation Listed NSF/ANSI Standard 2 - Food Equipment

OPERATING SPECIFICATIONS

ELECTRICAL CHARACTERISTICS

Input Voltage	Power Consumption	Power Factor	Input Current
120-277Vac	15W	>0.9	0.16A @ 120V 0.07A @ 277V

PHOTOMETRIC CHARACTERISTICS

Color Temperature (CCT)	4000K
Luminous Flux	1850 lm
Color Rendering Index (CRI)	>83
Efficacy	121 lm/W
Beam Angle	240°
Visible Light Area	325°

RATED LIFE

L70 (Hours)	50,000
-------------	--------

SPECTRAL DISTRIBUTION

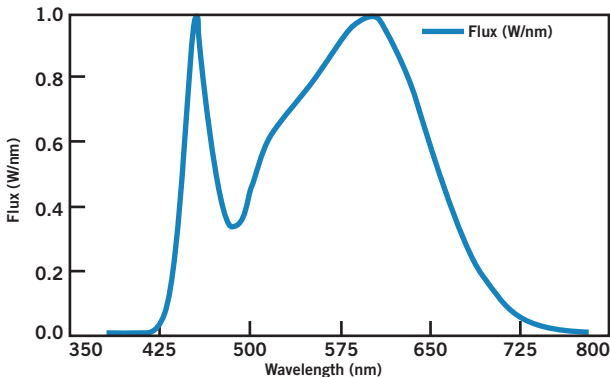

POLAR CANDELA DISTRIBUTION

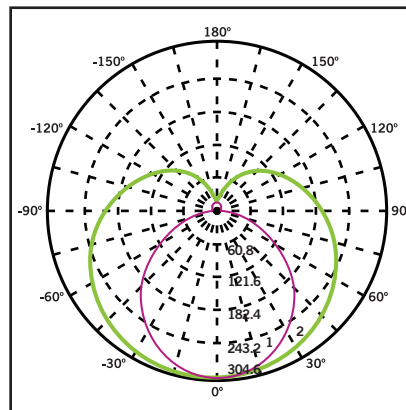

Maximum Candela = 1248.55
Located at Horizontal Angle = 0,
Vertical Angle 0

1. Violet Vertical Plane through Horizontal Angles (90-270)
2. Green Vertical Plane through Horizontal Angles (0-180)



KT-LED15T8-48GC-840-D

T8 LED LAMP

WIRING DIAGRAMS

1. Cut all existing connections to ballast as shown below and remove ballast.

Typical Ballast Configurations:

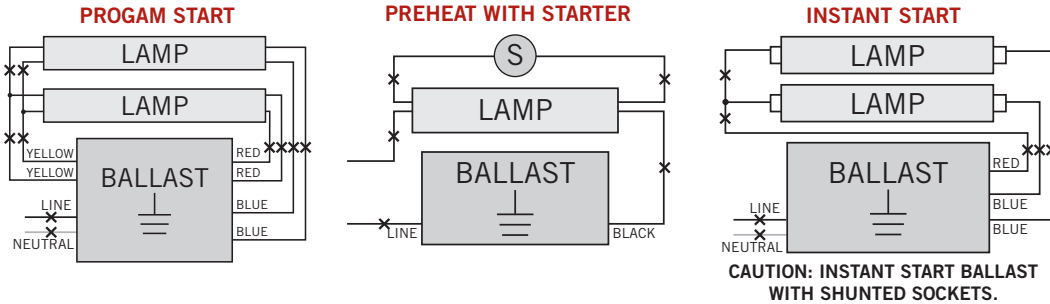

Typical Non-Shunted Lampholder

Connect wires directly to these terminals

CAUTION: Use only non-shunted lampholders.

Do not install product in a fixture with shunted lampholders (found in all fixtures using instant start ballasts). If the current lampholders are shunted, remove them and replace them with non-shunted lampholders. Make new connections directly to terminals as indicated above.

Keystone can provide any style replacement lampholders.
Call us at 800-464-2680.

2. Re-wire fixture as shown below.

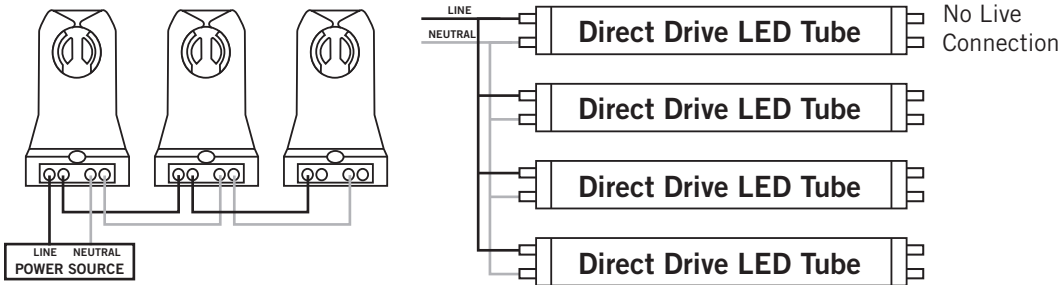

PHYSICAL CHARACTERISTICS

LAMP DIMENSIONS

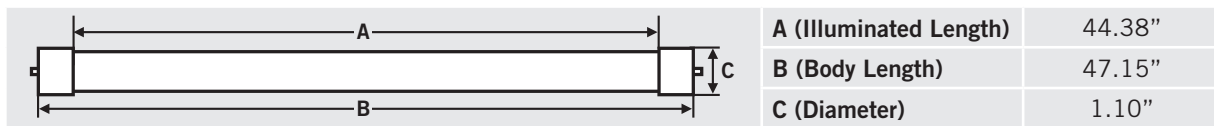

NOMINAL LENGTH: 48" BASE TYPE: G13 (Medium Bi-Pin)

ORDERING INFORMATION

ORDER CODE	PACKAGING STYLE	PACK QTY.	ITEM STATUS
KT-LED15T8-48GC-840-D /G3-CP	Carton Pack (Egg Crate Packaging)	25	Quick Ship
KT-LED15T8-48GC-840-D /G3-DP	Distributor Pack (Individual Cartons)	12	Quick Ship

CATALOG NUMBER BREAKDOWN

KT-LED15T8-48GC-840-D /G3-CP

