

Condulet conduit bodies – cast iron or aluminum

See page 8 for gaskets and covers

Applications:

Conduit outlet bodies are installed in conduit systems to:

- Act as pull outlets for conductors being installed
- Provide openings for making splices and taps in conductors
- Connect conduit sections
- Provide taps for branch conduit runs
- Make 90° bends in conduit runs
- Provide for access to conductors for maintenance and future system changes

Features:

Conduit outlet bodies:

- Form 7 Condulet® outlet bodies approach conduit in size for neat, compact installations
- Form 8 and Mark 9 bodies provide more room for heavier conductors
- Many shapes and sizes are available for rigid threaded conduit – for complete listings, see pages 6-13
- Conduit hubs have tapered threads and feature integral bushings for protection of wire insulation
- Form 7 has exclusive SNAPTIGHT™ and wedge nut cover attachment to provide clear, unobstructed cover opening
- Certified to UL50E (dusttight) when used with cover containing integral gasket

Gaskets:

Solid gaskets

- Are used with blank covers
- For Mark 9, can be converted to open type gaskets by tearing out center section along scored lines – ½" to 2" sizes
- For Form 7 are used with all covers

Open gaskets

- For Form 8 – ½" to 4" sizes
- For Mark 9 – 2½" to 4" sizes

Blank covers:

- Stainless steel cover screws are standard on Form 7, Form 8 and Mark 9 covers
- Form 7 – wedge nut design facilitates installation and removal; nuts are held captive in cover; covers can be used with or without gaskets; SNAPTIGHT Form 7 covers with integral sealing gaskets are installed without the use of screws, reducing installation time and costs; covers are reusable
- Form 8 – two cover screws provided on all sizes to provide tight cover and gasket assembly; Feraloy iron alloy covers have dome shapes for added strength and extra wiring room
- Mark 9 – self-retaining cover screws

Certifications and compliances:

Outlet bodies:

- UL standard: 514B
- Fed. Spec.: W-C-586D
- CSA standard: C22.2 No. 18
- NEMA 3R raintight (when installed with cover and gasket)
- UL50E dusttight Type 12

Standard materials:

- Form 7, Form 8 outlet bodies – Feraloy iron alloy
- Mark 9 outlet bodies – copper-free aluminum

Standard finishes:

- Form 7, Form 8 outlet bodies – electrogalvanized with aluminum acrylic paint
- Mark 9 outlet bodies – natural

Options:

Description

Suffix

Form 7 body and cover only:

- Copper-free aluminum **SA**
- Corro-free™ epoxy powder coat, external body only **S752**
- Corro-free epoxy powder coat, internal and external **S753**



Form 7



Mark 9



Form 8













Mogul

Condulet conduit bodies – cast iron or aluminum

See pages 10-13 for dimensions

Ordering information – threaded rigid bodies:

Shape	Style	Hub size									
		1/2"	3/4"	1"	1 1/4"	1 1/2"	2"	2 1/2"	3"	3 1/2"	4"
C											
	Form 7	C17	C27	C37	C47	C57	C67	C77	C87		
	Form 8	C18	C28	C38	C448	C58	C68	C78	C88		
	Mark 9	C19	C29	C39	C49	C59	C69	C789	C889	C989	C1089
E											
	Form 7	E17	E27	E37							
L											
	Form 7	L17	L27	L37	L47	L57	L67				
Double faced – may be used as LL or LR – has 2 openings, one of which is furnished with a blank sheet steel cover											
LB											
	Form 7	LB17	LB27	LB37	LB47	LB57	LB67	LB777	LB87	LB97	LB107
	Form 8	LB18	LB28	LB38	LB448	LB58	LB68	LB78	LB888	LB98	LB108
	Mark 9	LB19	LB29	LB39	LB49	LB59	LB69	LB789	LB889		LB1089
LL											
	Form 7	LL17	LL27	LL37	LL47	LL57	LL67	LL777	LL87	LL97	LL107
	Form 8	LL18	LL28	LL38	LL448	LL58	LL68	LL78	LL888		
	Mark 9	LL19	LL29	LL39	LL49	LL59	LL69	LL789	LL889	LL989	LL1089
LR											
	Form 7	LR17	LR27	LR37	LR47	LR57	LR67	LR777	LR87	LR97	LR107
	Form 8	LR18	LR28	LR38	LR448	LR58	LR68	LR78	LR888		
	Mark 9	LR19	LR29	LR39	LR49	LR59	LR69	LR789	LR889	LR989	LR1089
T											
	Form 7	T17	T27	T37	T47	T57	T67	T77	T87	T97	T107
	Form 8	T18	T28	T38	T448	T58	T68	T78	T88		
	Mark 9	T19	T29	T39	T49	T59	T69	T789	T889	T989	T1089
TA											
	Form 7	TA17	TA27	TA37	TA47	TA57	TA67				
TB											
	Form 7	TB17	TB27	TB37	TB47	TB57	TB67				
	Form 8	TB18	TB28	TB38	TB448	TB58	TB68				
	Mark 9	TB19	TB29	TB39	TB49	TB59	TB69				
U											
	Form 7	U17	U27	U37	U47	U57	U67				
X											
	Form 7	X17	X27	X37	X47	X57	X67				
	Form 8	X18	X28	X38	X448	X58	X68				
	Mark 9	X19	X29	X39							

Condulet conduit bodies – cast iron or aluminum

Covers and gaskets

Ordering information – blank covers:



Sheet steel

Size	Cat. # Form 7 wedge nut	Cat. # Form 7 SNAPTIGHT™ ^A	Cat. # Form 7 wedge nut with integral gasket ^C	Cat. # Form 8 ^E	Cat. # Form 8 with integral gasket ^C
1/2"	170	170SG	170G	180 ^E	180G ^E
3/4"	270	270SG	270G	280 ^E	280G ^E
1"	370	370SG	370G	380 ^E	380G ^E
1 1/4"	470	470SG	470G	480 ^E	480G ^E
1 1/2"	570	570SG	570G	580 ^E	580G ^E
2"	670	670SG	670G	680 ^E	680G ^E
2 1/2"	870		870G	880	
3"	870		870G	880	
3 1/2"	970		970G	980	
4"	970		970G	980	



Sheet aluminum

Feraloy iron alloy

Cast aluminum

Size	Cat. # Mark 9	Cat. # Mark 9 with integral gasket ^C	Cat. # Form 7	Cat. # Form 7 with integral gasket ^C	Cat. # Form 7 wedge nut	Cat. # Form 7 wedge nut with integral gasket ^C	Cat. # Form 8 ^D	Cat. # Form 7 wedge nut
1/2"	190	190G	170 SA	170G SA	170F	170FG	180F ^D	170F SA
3/4"	290	290G	270 SA	270G SA	270F	270FG	280F ^D	270F SA
1"	390	390G	370 SA	370G SA	370F	370FG	380F ^D	370F SA
1 1/4"	490	490G	470 SA	470G SA	470F	470FG	480F ^D	470F SA
1 1/2"	590	590G	570 SA	570G SA	570F	570FG	580F	570F SA
2"	690	690G	670 SA	670G SA	670F	670FG	680F	670F SA
2 1/2"	889		870 SA		870F		880F	870F SA
3"	889		870 SA		870F		880F	870F SA
3 1/2"	989		970 SA		970F		980F	970F SA
4"	989		970 SA		970F		980F	970F SA

Ordering information – neoprene solid gaskets:



Size	Cat. # Form 7	Cat. # Form 8 ^E	Cat. # Mark 9 ^F
1/2"	GASK571	GASK851N	GASK1941
3/4"	GASK572	GASK852N	GASK1942
1"	GASK573	GASK853N	GASK1943
1 1/4"	GASK574	GASK854N	GASK1944
1 1/2"	GASK575	GASK805N	GASK1945
2"	GASK576	GASK806N	GASK1946
2 1/2"	GASK578	GASK808N	GASK808N
3"	GASK578	GASK808N	GASK808N
3 1/2"	GASK579	GASK809N	GASK809N
4"	GASK579	GASK809N	GASK809N

- ^A Form 7 SNAPTIGHT covers with integral sealing gasket are installed without the use of screws.
- ^B Two cover screws on 1/2" to 2" Form 8 covers and four cover screws on 2 1/2" and larger Form 8 covers.
- ^C Urethane integral gaskets.
- ^D Two cover screws on 1/2" to 1 1/4" Form 8 covers and four cover screws on 1 1/2" and larger Form 8 covers.
- ^E 1/2" to 1 1/4" are solid gaskets; 1 1/2" to 4" are open gaskets.
- ^F 1/2" to 2" are solid gaskets; 2 1/4" to 4" are open gaskets.

Condulet conduit bodies – cast iron or aluminum

Dimensions (in inches):

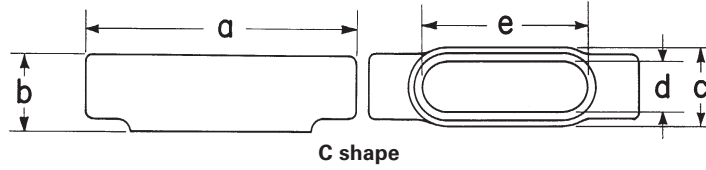

Form 7 C

Hub size	½"	¾"	1"	1¼"	1½"	2"	2½"	3"
a	5 ⁵ / ₈	6	7	7 ⁷ / ₁₆	8 ⁷ / ₁₆	9 ⁷ / ₁₆	12	11 ³ / ₄
b	1 ³ / ₈	1 ⁵ / ₈	1 ⁷ / ₈	2 ⁵ / ₁₆	2 ⁹ / ₁₆	3 ¹ / ₈	3 ⁵ / ₈	4 ³ / ₈
c	1 ³ / ₈	1 ³ / ₁₆	1 ³ / ₄	2 ³ / ₁₆	2 ⁷ / ₁₆	3	4 ¹ / ₄	4 ¹ / ₄
d	1 ⁵ / ₁₆	1 ¹ / ₈	1 ³ / ₈	1 ³ / ₄	1 ¹⁵ / ₁₆	2 ⁷ / ₁₆	3 ⁹ / ₁₆	3 ⁹ / ₁₆
e	3 ⁷ / ₁₆	3 ¹³ / ₁₆	4 ¹ / ₂	5	5 ⁷ / ₁₆	6 ³ / ₈	8 ³ / ₈	8 ³ / ₈

Form 8 C

Hub size	½"	¾"	1"	1¼"	1½"	2"	2½"	3"
a	5 ¹¹ / ₁₆	6 ³ / ₃₂	7 ⁷ / ₁₆	8 ¹ / ₂	10 ³ / ₈	12 ¹ / ₄	15 ⁵ / ₈	15 ⁵ / ₈
b	1 ⁷ / ₁₆	1 ¹¹ / ₁₆	1 ¹⁵ / ₁₆	2 ³ / ₈	2 ²⁵ / ₃₂	3 ³ / ₁₆	4 ⁷ / ₁₆	4 ¹³ / ₁₆
c	1 ³ / ₈	1 ³ / ₁₆	1 ³ / ₄	2 ³ / ₁₆	2 ⁷ / ₄	3 ³ / ₄	5	5
d	1	1 ³ / ₁₆	1 ³ / ₈	1 ³ / ₄	2 ¹ / ₈	3	4 ¹ / ₄	4 ¹ / ₄
e	3 ⁷ / ₁₆	3 ¹⁵ / ₁₆	4 ⁹ / ₁₆	5 ⁷ / ₁₆	6 ¹ / ₂	8 ⁷ / ₁₆	10 ¹ / ₈	10 ¹ / ₈

Mark 9 C

Hub size	½"	¾"	1"	1¼"	1½"	2"	2½"	3"	3½"	4"
a	4 ³¹ / ₃₂	5 ¹¹ / ₃₂	6 ¹⁹ / ₃₂	7 ⁵ / ₈	8 ¹¹ / ₃₂	10 ⁶ / ₈	15 ⁵ / ₈	15 ⁵ / ₈	18 ³ / ₄	18 ³ / ₄
b	1 ¹³ / ₃₂	1 ⁵ / ₈	1 ⁷ / ₈	2 ¹ / ₂	2 ¹³ / ₁₆	3 ⁷ / ₁₆	4 ⁷ / ₁₆	4 ⁹ / ₁₆	5 ¹¹ / ₁₆	5 ⁵ / ₁₆
c	1 ³ / ₈	1 ³ / ₁₆	1 ³ / ₄	2 ³ / ₁₆	2 ¹ / ₂	3 ⁷ / ₃₂	5	5	6 ¹ / ₄	6 ¹ / ₄
d	1 ¹ / ₈	1 ¹ / ₄	1 ³ / ₈	1 ²⁷ / ₃₂	2 ⁵ / ₃₂	2 ²⁵ / ₃₂	4 ¹ / ₄	4 ¹ / ₄	5 ¹ / ₁₆	5 ¹ / ₁₆
e	3 ⁹ / ₃₂	3 ²⁷ / ₃₂	4 ⁹ / ₁₆	5 ⁷ / ₁₆	5 ⁷ / ₈	8 ³ / ₃₂	10 ⁷ / ₈	10 ⁷ / ₈	13 ⁷ / ₁₆	13 ⁷ / ₁₆

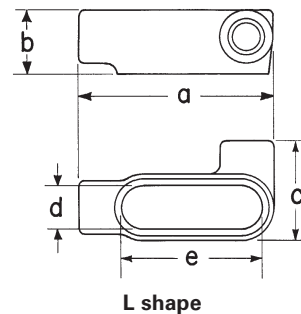
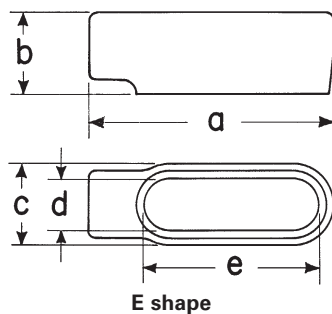

Form 7 E

Hub size	½"	¾"	1"
a	4 ⁹ / ₁₆	5 ³ / ₁₆	6
b	1 ³ / ₈	1 ⁵ / ₈	1 ⁷ / ₈
c	1 ³ / ₈	1 ³ / ₁₆	1 ³ / ₄
d	1 ⁵ / ₁₆	1 ¹ / ₈	1 ³ / ₈
e	3 ⁷ / ₁₆	3 ¹³ / ₁₆	4 ¹ / ₂

Form 7 L

Hub size	½"	¾"	1"	1¼"	1½"	2"
a	4 ⁹ / ₁₆	5 ³ / ₁₆	6	6 ¹ / ₂	7 ¹ / ₈	8 ¹ / ₈
b	1 ³ / ₈	1 ⁵ / ₈	1 ⁷ / ₈	2 ⁷ / ₁₆	2 ⁹ / ₁₆	3 ¹ / ₈
c	2 ¹ / ₄	2 ¹ / ₁₆	2 ³ / ₄	3 ³ / ₁₆	3 ⁹ / ₁₆	4 ¹ / ₈
d	1 ⁵ / ₁₆	1 ¹ / ₈	1 ³ / ₈	1 ³ / ₄	1 ¹⁵ / ₁₆	2 ¹ / ₁₆
e	3 ⁷ / ₁₆	3 ¹³ / ₁₆	4 ¹ / ₂	5	5 ⁷ / ₁₆	6 ³ / ₈

Condulet conduit bodies – cast iron or aluminum

Dimensions (in inches):

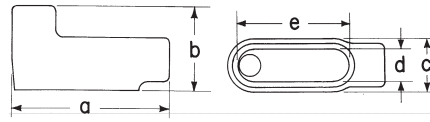

LB shape

Form 7 LB

Hub size	½"	¾"	1"	1¼"	1½"	2"	2½"	3"	3½"	4"
a	4 ⁹ / ₁₆	5 ³ / ₁₆	6	6½	7 ¹ / ₈	8 ¹ / ₈	10½	10½	12 ¹¹ / ₁₆	12 ¹¹ / ₁₆
b	2¼	2½	2 ⁷ / ₈	3 ⁵ / ₁₆	3 ¹¹ / ₁₆	4¼	5 ¹ / ₈	5 ¹ / ₈	6 ⁹ / ₁₆	7 ¹ / ₁₆
c	1 ³ / ₈	1 ³ / ₁₆	1 ³ / ₄	2 ³ / ₁₆	2 ¹ / ₁₆	3	4¼	4¼	5¼	5¼
d	1 ⁵ / ₁₆	1 ¹ / ₈	1 ³ / ₈	1 ³ / ₄	1 ¹⁵ / ₁₆	2 ¹ / ₁₆	3 ³ / ₁₆	3 ³ / ₁₆	4½	4½
e	3 ³ / ₁₆	3 ¹³ / ₁₆	4½	5	5 ¹ / ₁₆	6 ⁷ / ₈	8 ¹ / ₈	8 ¹ / ₈	10¼	10¼

Form 8 LB

Hub size	½"	¾"	1"	1¼"	1½"	2"	2½"	3"	3½"	4"
a	4 ¹⁵ / ₁₆	5 ³ / ₁₆	6 ¹⁵ / ₃₂	7 ¹⁷ / ₃₂	9 ¹ / ₈	11	13 ¹⁵ / ₁₆	13 ¹⁵ / ₁₆	16 ¹ / ₈	16 ¹ / ₈
b	2 ⁷ / ₃₂	2 ¹ / ₁₆	2 ¹³ / ₁₆	3 ¹¹ / ₃₂	4 ¹ / ₃₂	4 ¹³ / ₁₆	6 ¹ / ₈	6 ¹ / ₂	7 ⁹ / ₁₆	7 ⁹ / ₁₆
c	1 ³ / ₈	1 ³ / ₁₆	1 ³ / ₄	2 ³ / ₁₆	2 ¹ / ₄	3 ³ / ₄	5	5	6¼	6¼
d	1	1 ³ / ₁₆	1 ³ / ₈	1 ³ / ₄	2 ¹ / ₈	3	4¼	4¼	5 ¹ / ₁₆	5 ¹ / ₁₆
e	3 ³ / ₁₆	3 ¹⁵ / ₁₆	4 ⁹ / ₁₆	5 ⁵ / ₁₆	6½	8 ⁷ / ₁₆	10 ¹ / ₈	10 ¹ / ₈	13 ¹ / ₁₆	13 ¹ / ₁₆

Mark 9 LB

Hub size	½"	¾"	1"	1¼"	1½"	2"	2½"	3"	3½"	4"
a	4 ¹⁹ / ₃₂	5¼	6 ³ / ₃₂	7 ³ / ₃₂	7 ²⁵ / ₃₂	10 ³ / ₃₂	13 ¹⁵ / ₁₆	13 ¹⁵ / ₁₆	16 ¹ / ₈	16 ¹ / ₈
b	2 ¹ / ₈	2 ¹⁵ / ₃₂	2 ¹³ / ₁₆	3 ⁵ / ₈	3 ¹ / ₈	4 ¹⁹ / ₃₂	6 ¹ / ₈	6 ¹ / ₂	7 ⁹ / ₁₆	7 ⁹ / ₁₆
c	1 ³ / ₈	1 ¹⁵ / ₃₂	1 ³ / ₄	2 ³ / ₁₆	2 ¹ / ₂	3 ³ / ₃₂	5	5	6¼	6¼
d	1 ¹ / ₁₆	1 ⁹ / ₃₂	1 ¹ / ₁₆	1 ⁷ / ₈	2 ¹ / ₁₆	2 ²⁹ / ₃₂	4¼	4¼	5 ¹ / ₁₆	5 ¹ / ₁₆
e	3 ⁹ / ₃₂	3 ²⁷ / ₃₂	4 ⁹ / ₁₆	5 ³ / ₁₆	5 ¹ / ₈	8 ³ / ₃₂	10 ¹ / ₈	10 ¹ / ₈	13 ¹ / ₁₆	13 ¹ / ₁₆

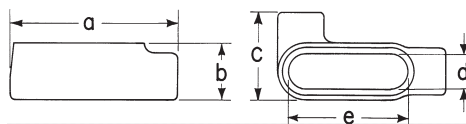

LL shape

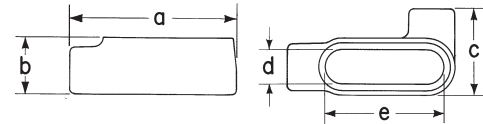

LR shape

Form 7 LL & LR

Hub size	½"	¾"	1"	1¼"	1½"	2"	2½"	3"	3½"	4"
a	4 ⁹ / ₁₆	5 ³ / ₁₆	6	6½	7 ¹ / ₈	8 ¹ / ₈	10½	10½	12 ¹¹ / ₁₆	12 ¹¹ / ₁₆
b	1 ³ / ₈	1 ³ / ₁₆	1 ⁷ / ₈	2 ¹ / ₁₆	2 ¹ / ₁₆	3 ¹ / ₈	3 ³ / ₈	4 ⁷ / ₈	4 ⁷ / ₈	5 ¹ / ₈
c	2¼	2 ¹ / ₁₆	2 ³ / ₄	3 ⁵ / ₁₆	3 ¹ / ₁₆	4 ¹ / ₈	5¼	5¼	6 ¹⁵ / ₁₆	6 ¹⁵ / ₁₆
d	1 ⁵ / ₁₆	1 ¹ / ₈	1 ³ / ₈	1 ³ / ₄	1 ¹⁵ / ₁₆	2 ¹ / ₁₆	3 ³ / ₁₆	3 ³ / ₁₆	4½	4½
e	3 ³ / ₁₆	3 ¹³ / ₁₆	4½	5	5 ¹ / ₁₆	6 ⁷ / ₈	8 ¹ / ₈	8 ¹ / ₈	10¼	10¼

Form 8 LL & LR

Hub size	½"	¾"	1"	1¼"	1½"	2"	2½"	3"
a	4 ¹⁵ / ₁₆	5 ³ / ₁₆	6 ¹⁵ / ₃₂	7 ¹⁷ / ₃₂	9 ¹ / ₈	11	13 ¹⁵ / ₁₆	13 ¹⁵ / ₁₆
b	1 ¹ / ₁₆	1 ¹¹ / ₁₆	1 ¹⁵ / ₁₆	2 ¹ / ₈	2 ²⁹ / ₃₂	3 ¹ / ₁₆	4 ¹ / ₁₆	4 ¹³ / ₁₆
c	2 ² / ₃₂	2 ¹ / ₁₆	2 ⁵ / ₈	3 ⁵ / ₃₂	4	5	6 ¹¹ / ₁₆	6 ¹¹ / ₁₆
d	1	1 ³ / ₁₆	1 ³ / ₈	1 ³ / ₄	2 ¹ / ₈	3	4¼	4¼
e	3 ³ / ₁₆	3 ¹⁵ / ₁₆	4 ⁹ / ₁₆	5 ⁵ / ₁₆	6½	8 ⁷ / ₁₆	10 ¹ / ₈	10 ¹ / ₈

Mark 9 LL & LR

Hub size	½"	¾"	1"	1¼"	1½"	2"	2½"	3"	3½"	4"
a	4 ¹⁹ / ₃₂	5¼	6 ³ / ₃₂	7 ³ / ₃₂	7 ⁵¹ / ₆₄	10 ³ / ₃₂	13 ¹⁵ / ₁₆	13 ¹⁵ / ₁₆	16 ¹ / ₈	16 ¹ / ₈
b	1 ¹³ / ₃₂	1 ⁵ / ₈	1 ⁷ / ₈	2 ¹ / ₂	2 ³ / ₁₆	3 ¹ / ₁₆	4 ¹ / ₁₆	4 ¹⁹ / ₁₆	5 ¹¹ / ₁₆	5 ⁹ / ₁₆
c	2 ¹ / ₈	2 ⁵ / ₁₆	2 ¹ / ₁₆	3¼	3½	4 ¹³ / ₆₄	6 ¹¹ / ₁₆	6 ¹ / ₁₆	8 ¹ / ₈	8 ¹ / ₈
d	1 ¹ / ₁₆	1 ¹ / ₄	1 ³ / ₈	1 ³ / ₄	2 ¹ / ₁₆	2 ²⁹ / ₃₂	4¼	4¼	5 ¹ / ₁₆	5 ¹ / ₁₆
e	3 ⁹ / ₃₂	3 ²⁷ / ₃₂	4 ⁹ / ₁₆	5 ³ / ₁₆	5 ¹ / ₈	8 ³ / ₃₂	10 ¹ / ₈	10 ¹ / ₈	13 ¹ / ₁₆	13 ¹ / ₁₆

Condulet conduit bodies – cast iron or aluminum

Dimensions (in inches):

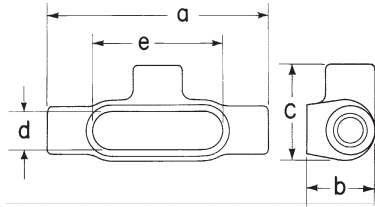

T shape

Form 7 T

Hub size	a	b	c	d	e
1/2"	5 ⁵ / ₈	1 ³ / ₄	2 ⁷ / ₁₆	1 ⁵ / ₁₆	3 ⁷ / ₁₆
3/4"	6 ¹ / ₄	2	2 ⁵ / ₈	1 ¹ / ₈	3 ¹³ / ₁₆
1"	7 ¹ / ₄	2 ¹ / ₄	3	1 ³ / ₈	4 ¹ / ₂
1 1/4"	7 ⁷ / ₁₆	2 ⁵ / ₁₆	3 ³ / ₁₆	1 ³ / ₄	5
1 1/2"	8 ³ / ₁₆	2 ⁹ / ₁₆	3 ⁹ / ₁₆	1 ¹⁵ / ₁₆	5 ¹ / ₁₆
2"	9 ³ / ₁₆	3 ³ / ₈	4 ¹ / ₈	2 ¹ / ₁₆	6 ³ / ₈
2 1/2"	12	3 ³ / ₈	5 ¹ / ₄	3 ⁷ / ₁₆	8 ⁷ / ₈
3"	12 ¹ / ₁₆	4 ³ / ₈	5 ¹ / ₄	3 ⁹ / ₁₆	8 ⁷ / ₈
3 1/2"	14 ⁷ / ₁₆	4 ⁷ / ₈	6 ¹⁵ / ₁₆	4 ¹ / ₂	10 ¹ / ₄
4"	14 ⁹ / ₁₆	5 ³ / ₈	6 ¹⁵ / ₁₆	4 ¹ / ₂	10 ¹ / ₄

Form 8 T

Hub size	a	b	c	d	e
1/2"	5 ¹¹ / ₁₆	1 ³ / ₄	2 ⁹ / ₃₂	1	3 ⁹ / ₁₆
3/4"	6 ⁹ / ₃₂	2	2 ⁹ / ₁₆	1 ¹ / ₁₆	3 ¹⁵ / ₁₆
1"	7 ⁷ / ₁₆	2 ¹ / ₄	2 ⁵ / ₈	1 ³ / ₈	4 ⁷ / ₁₆
1 1/4"	8 ¹ / ₂	2 ⁵ / ₈	3 ⁵ / ₃₂	1 ³ / ₄	5 ⁵ / ₁₆
1 1/2"	10 ³ / ₈	2 ²⁵ / ₃₂	4	2 ¹ / ₈	6 ¹ / ₂
2"	12 ¹ / ₄	3 ⁹ / ₁₆	5	3	8 ⁷ / ₁₆
2 1/2"	15 ⁵ / ₈	4 ¹ / ₁₆	6 ¹¹ / ₁₆	4 ¹ / ₄	10 ⁷ / ₈
3"	15 ⁵ / ₈	4 ¹³ / ₁₆	6 ¹¹ / ₁₆	4 ¹ / ₄	10 ⁷ / ₈

Mark 9 T

Hub size	a	b	c	d	e
1/2"	5	1 ¹³ / ₃₂	2 ¹ / ₈	1 ¹ / ₁₆	3 ⁹ / ₃₂
3/4"	5 ¹¹ / ₁₆	1 ⁵ / ₈	2 ⁵ / ₁₆	1 ¹ / ₄	3 ²⁷ / ₃₂
1"	6 ¹⁹ / ₃₂	1 ⁷ / ₈	2 ¹¹ / ₁₆	1 ³ / ₈	4 ⁷ / ₁₆
1 1/4"	7 ⁷ / ₈	2 ¹ / ₂	3 ¹ / ₄	1 ⁷ / ₈	5 ¹ / ₁₆
1 1/2"	8 ¹¹ / ₃₂	2 ¹³ / ₁₆	3 ¹ / ₂	2 ¹ / ₁₆	5 ⁷ / ₈
2"	10 ³ / ₈	3 ¹ / ₁₆	4 ¹³ / ₃₂	2 ²⁹ / ₃₂	8 ⁷ / ₃₂
2 1/2"	15 ⁵ / ₈	4 ⁷ / ₁₆	6 ¹¹ / ₁₆	4 ¹ / ₄	10 ⁷ / ₈
3"	15 ⁵ / ₈	4 ¹³ / ₁₆	6 ¹¹ / ₁₆	4 ¹ / ₄	10 ⁷ / ₈
3 1/2"	18 ⁷ / ₄	5 ¹¹ / ₁₆	8 ⁷ / ₈	5 ¹ / ₁₆	13 ¹ / ₁₆
4"	18 ⁷ / ₄	5 ¹⁵ / ₁₆	8 ⁷ / ₈	5 ¹ / ₁₆	13 ¹ / ₁₆

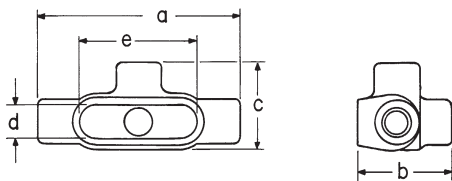

TA shape

Form 7 TA

Hub size	a	b	c	d	e
1/2"	5 ⁵ / ₈	2 ⁵ / ₈	2 ⁷ / ₁₆	1 ⁵ / ₁₆	3 ⁷ / ₁₆
3/4"	6 ¹ / ₄	2 ¹ / ₈	2 ⁵ / ₈	1 ¹ / ₈	3 ¹³ / ₁₆
1"	7 ¹ / ₄	3 ¹ / ₄	3	1 ³ / ₈	4 ¹ / ₂
1 1/4"	7 ⁷ / ₁₆	3 ⁵ / ₁₆	3 ³ / ₁₆	1 ³ / ₄	5
1 1/2"	8 ³ / ₁₆	3 ¹¹ / ₁₆	3 ⁹ / ₁₆	1 ¹⁵ / ₁₆	5 ¹ / ₁₆
2"	9 ³ / ₁₆	4 ¹ / ₄	4 ¹ / ₈	2 ¹ / ₁₆	6 ³ / ₈

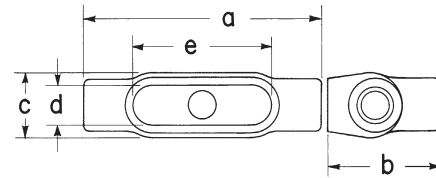

TB shape

Form 7 TB

Hub size	a	b	c	d	e
1/2"	5 ⁵ / ₈	2 ⁵ / ₈	1 ⁹ / ₁₆	1 ⁵ / ₁₆	3 ⁷ / ₁₆
3/4"	6 ¹ / ₄	2 ¹ / ₈	1 ³ / ₄	1 ¹ / ₈	3 ¹³ / ₁₆
1"	7 ¹ / ₄	3 ¹ / ₄	2	1 ³ / ₈	4 ¹ / ₂
1 1/4"	7 ⁷ / ₁₆	3 ⁵ / ₁₆	2 ³ / ₁₆	1 ³ / ₄	5
1 1/2"	8 ³ / ₁₆	5	2 ¹ / ₁₆	1 ¹⁵ / ₁₆	5 ¹ / ₁₆
2"	9 ³ / ₁₆	6 ¹ / ₈	3	2 ¹ / ₁₆	6 ³ / ₈

Form 8 TB

Hub size	a	b	c	d	e
1/2"	5 ¹¹ / ₁₆	2 ¹⁷ / ₃₂	1 ³ / ₈	1	3 ⁹ / ₁₆
3/4"	6 ⁹ / ₃₂	2 ³ / ₄	1 ⁹ / ₁₆	1 ³ / ₁₆	3 ¹⁵ / ₁₆
1"	7 ⁷ / ₁₆	3 ¹ / ₈	1 ³ / ₄	1 ³ / ₈	4 ⁷ / ₁₆
1 1/4"	8 ¹ / ₂	3 ¹¹ / ₃₂	2 ³ / ₁₆	1 ³ / ₄	5 ⁵ / ₁₆
1 1/2"	10 ³ / ₈	4 ¹ / ₃₂	2 ¹ / ₄	2 ¹ / ₈	6 ¹ / ₂
2"	12 ¹ / ₄	4 ¹³ / ₁₆	3 ³ / ₄	3	8 ⁷ / ₁₆

Mark 9 TB

Hub size	a	b	c	d	e
1/2"	5 ¹¹ / ₁₆	2 ³³ / ₆₄	1 ³ / ₈	1	3 ⁹ / ₁₆
3/4"	6 ⁹ / ₁₆	2 ¹ / ₈	1 ⁹ / ₁₆	1 ³ / ₁₆	3 ¹⁵ / ₁₆
1"	7 ⁷ / ₁₆	3 ¹ / ₈	1 ³ / ₄	1 ³ / ₈	4 ⁷ / ₁₆
1 1/4"	8 ¹ / ₂	3 ¹¹ / ₃₂	2 ³ / ₁₆	1 ³ / ₄	5 ⁵ / ₁₆
1 1/2"	8 ¹¹ / ₃₂	3 ¹ / ₈	2 ¹ / ₂	2 ³ / ₁₆	5 ⁷ / ₈
2"	10 ⁷ / ₈	4 ¹⁵ / ₃₂	3 ¹ / ₃₂	2 ¹³ / ₁₆	8 ⁷ / ₃₂

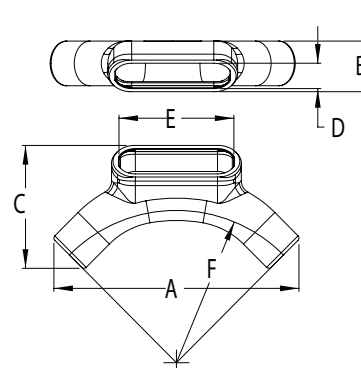

U shape

Form 7 U

Hub size	A	B	C	D	E	F (bend radius)
1/2"	7 ¹ / ₈	1 ¹ / ₂	3 ¹¹ / ₁₆	1 ⁵ / ₁₆	3 ⁷ / ₁₆	4.4
3/4"	7 ¹ / ₂	1 ¹¹ / ₁₆	3 ⁷ / ₈	1 ¹ / ₈	3 ¹³ / ₁₆	4.6
1"	9 ¹¹ / ₁₆	2	4 ¹³ / ₁₆	1 ³ / ₈	4 ¹ / ₂	6.0
1 1/4"	12	2 ¹ / ₂	5 ¹⁵ / ₁₆	1 ³ / ₄	5	7.4
1 1/2"	15 ⁵ / ₈	2 ⁷ / ₈	7 ³ / ₁₆	1 ¹⁵ / ₁₆	5 ¹ / ₁₆	9.6
2"	17 ⁹ / ₁₆	3 ³ / ₈	8 ³ / ₈	2 ¹ / ₁₆	6 ³ / ₈	10.9

Condulet conduit bodies – cast iron or aluminum

Dimensions (in inches):

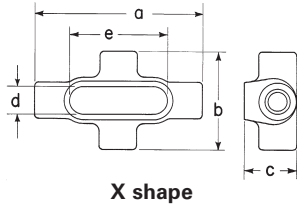

Form 7 X

Hub size	a	b	c	d	e
1/2"	5 ⁵ / ₈	3 ⁵ / ₁₆	1 ³ / ₄	1 ⁵ / ₁₆	3 ³ / ₁₆
3/4"	6 ¹ / ₄	3 ¹ / ₂	2	1 ¹ / ₈	3 ¹³ / ₁₆
1"	7 ¹ / ₄	4	2 ¹ / ₄	1 ³ / ₈	4 ¹ / ₂
1 1/4"	7 ⁷ / ₁₆	4 ¹ / ₈	2 ⁵ / ₁₆	1 ³ / ₄	5
1 1/2"	8 ³ / ₁₆	4 ⁵ / ₈	2 ³ / ₁₆	1 ¹⁵ / ₁₆	5 ¹ / ₁₆
2"	9 ³ / ₁₆	5 ³ / ₁₆	3 ¹ / ₈	2 ¹ / ₁₆	6 ³ / ₈

Form 8 X

Hub size	a	b	c	d	e
1/2"	5 ¹¹ / ₁₆	2 ²⁹ / ₃₂	1 ³ / ₄	1	3 ⁷ / ₁₆
3/4"	6 ⁹ / ₃₂	3 ¹ / ₁₆	2	1 ³ / ₁₆	3 ¹⁵ / ₁₆
1"	7 ³ / ₁₆	3 ¹ / ₂	2 ¹ / ₄	1 ³ / ₈	4 ⁹ / ₁₆
1 1/4"	8 ¹ / ₂	4 ¹ / ₈	2 ⁵ / ₈	1 ³ / ₄	5 ⁵ / ₁₆
1 1/2"	10 ³ / ₈	5 ¹ / ₄	2 ¹⁵ / ₃₂	2 ¹ / ₈	6 ¹ / ₂
2"	12 ¹ / ₄	6 ¹ / ₄	3 ³ / ₁₆	3	8 ³ / ₁₆

Mark 9 X

Hub size	a	b	c	d	e
1/2"	5 ¹¹ / ₁₆	2 ⁵⁷ / ₆₄	1 ³ / ₄	1	3 ⁵ / ₁₆
3/4"	6 ⁹ / ₁₆	3 ¹ / ₄	2	1 ³ / ₁₆	3 ¹⁵ / ₁₆
1"	7 ⁵ / ₁₆	3 ¹ / ₂	2 ¹ / ₄	1 ³ / ₈	4 ⁹ / ₁₆

Condulet conduit bodies – cast iron or aluminum

See page 8 for gaskets and covers

Applications:

Conduit outlet bodies are installed in conduit systems to:

- Act as pull outlets for conductors being installed
- Provide openings for making splices and taps in conductors
- Connect conduit sections
- Provide taps for branch conduit runs
- Make 90° bends in conduit runs
- Provide for access to conductors for maintenance and future system changes

Features:

Conduit outlet bodies:

- Form 7 Condulet® outlet bodies approach conduit in size for neat, compact installations
- Form 8 and Mark 9 bodies provide more room for heavier conductors
- Many shapes and sizes are available for rigid threaded conduit – for complete listings, see pages 6-13
- Conduit hubs have tapered threads and feature integral bushings for protection of wire insulation
- Form 7 has exclusive SNAPTIGHT™ and wedge nut cover attachment to provide clear, unobstructed cover opening
- Certified to UL50E (dusttight) when used with cover containing integral gasket

Gaskets:

Solid gaskets

- Are used with blank covers
- For Mark 9, can be converted to open type gaskets by tearing out center section along scored lines – ½" to 2" sizes
- For Form 7 are used with all covers

Open gaskets

- For Form 8 – ½" to 4" sizes
- For Mark 9 – 2½" to 4" sizes

Blank covers:

- Stainless steel cover screws are standard on Form 7, Form 8 and Mark 9 covers
- Form 7 – wedge nut design facilitates installation and removal; nuts are held captive in cover; covers can be used with or without gaskets; SNAPTIGHT Form 7 covers with integral sealing gaskets are installed without the use of screws, reducing installation time and costs; covers are reusable
- Form 8 – two cover screws provided on all sizes to provide tight cover and gasket assembly; Feraloy iron alloy covers have dome shapes for added strength and extra wiring room
- Mark 9 – self-retaining cover screws

Certifications and compliances:

Outlet bodies:

- UL standard: 514B
- Fed. Spec.: W-C-586D
- CSA standard: C22.2 No. 18
- NEMA 3R raintight (when installed with cover and gasket)
- UL50E dusttight Type 12

Standard materials:

- Form 7, Form 8 outlet bodies – Feraloy iron alloy
- Mark 9 outlet bodies – copper-free aluminum

Standard finishes:

- Form 7, Form 8 outlet bodies – electrogalvanized with aluminum acrylic paint
- Mark 9 outlet bodies – natural

Options:

Description

Suffix

Form 7 body and cover only:

- Copper-free aluminum **SA**
- Corro-free™ epoxy powder coat, external body only **S752**
- Corro-free epoxy powder coat, internal and external **S753**



Form 7



Mark 9



Form 8













Mogul

Condulet conduit bodies – cast iron or aluminum

See pages 10-13 for dimensions

Ordering information – threaded rigid bodies:

Shape	Style	Hub size									
		1/2"	3/4"	1"	1 1/4"	1 1/2"	2"	2 1/2"	3"	3 1/2"	4"
C											
	Form 7	C17	C27	C37	C47	C57	C67	C77	C87		
	Form 8	C18	C28	C38	C448	C58	C68	C78	C88		
	Mark 9	C19	C29	C39	C49	C59	C69	C789	C889	C989	C1089
E											
	Form 7	E17	E27	E37							
L											
	Form 7	L17	L27	L37	L47	L57	L67				
Double faced – may be used as LL or LR – has 2 openings, one of which is furnished with a blank sheet steel cover											
LB											
	Form 7	LB17	LB27	LB37	LB47	LB57	LB67	LB777	LB87	LB97	LB107
	Form 8	LB18	LB28	LB38	LB448	LB58	LB68	LB78	LB888	LB98	LB108
	Mark 9	LB19	LB29	LB39	LB49	LB59	LB69	LB789	LB889		LB1089
LL											
	Form 7	LL17	LL27	LL37	LL47	LL57	LL67	LL777	LL87	LL97	LL107
	Form 8	LL18	LL28	LL38	LL448	LL58	LL68	LL78	LL888		
	Mark 9	LL19	LL29	LL39	LL49	LL59	LL69	LL789	LL889	LL989	LL1089
LR											
	Form 7	LR17	LR27	LR37	LR47	LR57	LR67	LR777	LR87	LR97	LR107
	Form 8	LR18	LR28	LR38	LR448	LR58	LR68	LR78	LR888		
	Mark 9	LR19	LR29	LR39	LR49	LR59	LR69	LR789	LR889	LR989	LR1089
T											
	Form 7	T17	T27	T37	T47	T57	T67	T77	T87	T97	T107
	Form 8	T18	T28	T38	T448	T58	T68	T78	T88		
	Mark 9	T19	T29	T39	T49	T59	T69	T789	T889	T989	T1089
TA											
	Form 7	TA17	TA27	TA37	TA47	TA57	TA67				
TB											
	Form 7	TB17	TB27	TB37	TB47	TB57	TB67				
	Form 8	TB18	TB28	TB38	TB448	TB58	TB68				
	Mark 9	TB19	TB29	TB39	TB49	TB59	TB69				
U											
	Form 7	U17	U27	U37	U47	U57	U67				
X											
	Form 7	X17	X27	X37	X47	X57	X67				
	Form 8	X18	X28	X38	X448	X58	X68				
	Mark 9	X19	X29	X39							

Condulet conduit bodies – cast iron or aluminum

Covers and gaskets

Ordering information – blank covers:



Sheet steel

Size	Cat. # Form 7 wedge nut	Cat. # Form 7 SNAPTIGHT™ ^A	Cat. # Form 7 wedge nut with integral gasket ^C	Cat. # Form 8 ^E	Cat. # Form 8 with integral gasket ^C
1/2"	170	170SG	170G	180 ^E	180G ^E
3/4"	270	270SG	270G	280 ^E	280G ^E
1"	370	370SG	370G	380 ^E	380G ^E
1 1/4"	470	470SG	470G	480 ^E	480G ^E
1 1/2"	570	570SG	570G	580 ^E	580G ^E
2"	670	670SG	670G	680 ^E	680G ^E
2 1/2"	870		870G	880	
3"	870		870G	880	
3 1/2"	970		970G	980	
4"	970		970G	980	



Sheet aluminum



Feraloy iron alloy



Cast aluminum

Size	Cat. # Mark 9	Cat. # Mark 9 with integral gasket ^C	Cat. # Form 7	Cat. # Form 7 with integral gasket ^C	Cat. # Form 7 wedge nut	Cat. # Form 7 wedge nut with integral gasket ^C	Cat. # Form 8 ^D	Cat. # Form 7 wedge nut
1/2"	190	190G	170 SA	170G SA	170F	170FG	180F ^D	170F SA
3/4"	290	290G	270 SA	270G SA	270F	270FG	280F ^D	270F SA
1"	390	390G	370 SA	370G SA	370F	370FG	380F ^D	370F SA
1 1/4"	490	490G	470 SA	470G SA	470F	470FG	480F ^D	470F SA
1 1/2"	590	590G	570 SA	570G SA	570F	570FG	580F	570F SA
2"	690	690G	670 SA	670G SA	670F	670FG	680F	670F SA
2 1/2"	889		870 SA		870F		880F	870F SA
3"	889		870 SA		870F		880F	870F SA
3 1/2"	989		970 SA		970F		980F	970F SA
4"	989		970 SA		970F		980F	970F SA

Ordering information – neoprene solid gaskets:



Size	Cat. # Form 7	Cat. # Form 8 ^E	Cat. # Mark 9 ^F
1/2"	GASK571	GASK851N	GASK1941
3/4"	GASK572	GASK852N	GASK1942
1"	GASK573	GASK853N	GASK1943
1 1/4"	GASK574	GASK854N	GASK1944
1 1/2"	GASK575	GASK805N	GASK1945
2"	GASK576	GASK806N	GASK1946
2 1/2"	GASK578	GASK808N	GASK808N
3"	GASK578	GASK808N	GASK808N
3 1/2"	GASK579	GASK809N	GASK809N
4"	GASK579	GASK809N	GASK809N

- ^A Form 7 SNAPTIGHT covers with integral sealing gasket are installed without the use of screws.
- ^B Two cover screws on 1/2" to 2" Form 8 covers and four cover screws on 2 1/2" and larger Form 8 covers.
- ^C Urethane integral gaskets.
- ^D Two cover screws on 1/2" to 1 1/4" Form 8 covers and four cover screws on 1 1/2" and larger Form 8 covers.
- ^E 1/2" to 1 1/4" are solid gaskets; 1 1/2" to 4" are open gaskets.
- ^F 1/2" to 2" are solid gaskets; 2 1/4" to 4" are open gaskets.

Condulet conduit bodies – cast iron or aluminum

Dimensions (in inches):

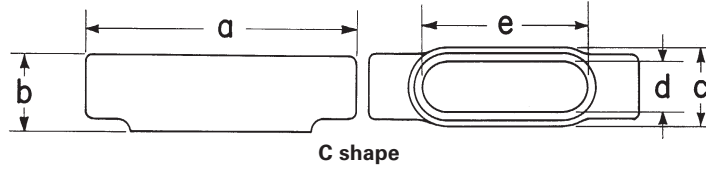

Form 7 C

Hub size	½"	¾"	1"	1¼"	1½"	2"	2½"	3"
a	5 ⁵ / ₈	6	7	7 ⁷ / ₁₆	8 ⁷ / ₁₆	9 ⁷ / ₁₆	12	11 ³ / ₄
b	1 ³ / ₈	1 ⁵ / ₈	1 ⁷ / ₈	2 ⁵ / ₁₆	2 ⁹ / ₁₆	3 ¹ / ₈	3 ⁵ / ₈	4 ³ / ₈
c	1 ³ / ₈	1 ³ / ₁₆	1 ³ / ₄	2 ³ / ₁₆	2 ⁷ / ₁₆	3	4 ¹ / ₄	4 ¹ / ₄
d	1 ⁵ / ₁₆	1 ¹ / ₈	1 ³ / ₈	1 ³ / ₄	1 ¹⁵ / ₁₆	2 ⁷ / ₁₆	3 ⁹ / ₁₆	3 ⁹ / ₁₆
e	3 ⁷ / ₁₆	3 ¹³ / ₁₆	4 ¹ / ₂	5	5 ⁷ / ₁₆	6 ³ / ₈	8 ³ / ₈	8 ³ / ₈

Form 8 C

Hub size	½"	¾"	1"	1¼"	1½"	2"	2½"	3"
a	5 ¹¹ / ₁₆	6 ³ / ₃₂	7 ⁷ / ₁₆	8 ¹ / ₂	10 ³ / ₈	12 ¹ / ₄	15 ⁵ / ₈	15 ⁵ / ₈
b	1 ⁷ / ₁₆	1 ¹¹ / ₁₆	1 ¹⁵ / ₁₆	2 ³ / ₈	2 ²⁵ / ₃₂	3 ³ / ₁₆	4 ⁷ / ₁₆	4 ¹³ / ₁₆
c	1 ³ / ₈	1 ³ / ₁₆	1 ³ / ₄	2 ³ / ₁₆	2 ⁷ / ₄	3 ³ / ₄	5	5
d	1	1 ³ / ₁₆	1 ³ / ₈	1 ³ / ₄	2 ¹ / ₈	3	4 ¹ / ₄	4 ¹ / ₄
e	3 ⁷ / ₁₆	3 ¹⁵ / ₁₆	4 ⁹ / ₁₆	5 ⁷ / ₁₆	6 ¹ / ₂	8 ⁷ / ₁₆	10 ¹ / ₈	10 ¹ / ₈

Mark 9 C

Hub size	½"	¾"	1"	1¼"	1½"	2"	2½"	3"	3½"	4"
a	4 ³¹ / ₃₂	5 ¹¹ / ₃₂	6 ¹⁹ / ₃₂	7 ⁵ / ₈	8 ¹¹ / ₃₂	10 ⁶ / ₈	15 ⁵ / ₈	15 ⁵ / ₈	18 ³ / ₄	18 ³ / ₄
b	1 ¹³ / ₃₂	1 ⁵ / ₈	1 ⁷ / ₈	2 ¹ / ₂	2 ¹³ / ₁₆	3 ⁷ / ₁₆	4 ⁷ / ₁₆	4 ¹³ / ₁₆	5 ¹¹ / ₁₆	5 ⁵ / ₁₆
c	1 ³ / ₈	1 ³ / ₁₆	1 ³ / ₄	2 ³ / ₁₆	2 ¹ / ₂	3 ⁷ / ₃₂	5	5	6 ¹ / ₄	6 ¹ / ₄
d	1 ¹ / ₈	1 ¹ / ₄	1 ³ / ₈	1 ²⁷ / ₃₂	2 ⁵ / ₃₂	2 ²⁵ / ₃₂	4 ¹ / ₄	4 ¹ / ₄	5 ¹ / ₁₆	5 ¹ / ₁₆
e	3 ⁹ / ₃₂	3 ²⁷ / ₃₂	4 ⁹ / ₁₆	5 ⁷ / ₁₆	5 ⁷ / ₈	8 ³ / ₃₂	10 ⁷ / ₈	10 ⁷ / ₈	13 ⁷ / ₁₆	13 ⁷ / ₁₆

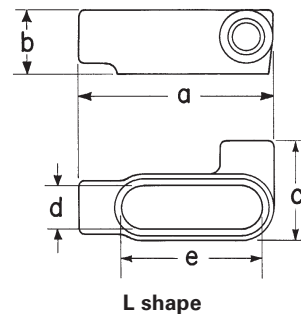
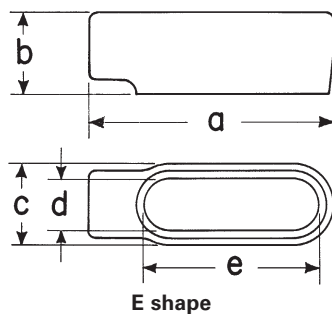

Form 7 E

Hub size	½"	¾"	1"
a	4 ⁹ / ₁₆	5 ³ / ₁₆	6
b	1 ³ / ₈	1 ⁵ / ₈	1 ⁷ / ₈
c	1 ³ / ₈	1 ³ / ₁₆	1 ³ / ₄
d	1 ⁵ / ₁₆	1 ¹ / ₈	1 ³ / ₈
e	3 ⁷ / ₁₆	3 ¹³ / ₁₆	4 ¹ / ₂

Form 7 L

Hub size	½"	¾"	1"	1¼"	1½"	2"
a	4 ⁹ / ₁₆	5 ³ / ₁₆	6	6 ¹ / ₂	7 ¹ / ₈	8 ¹ / ₈
b	1 ³ / ₈	1 ⁵ / ₈	1 ⁷ / ₈	2 ⁷ / ₁₆	2 ⁷ / ₁₆	3 ¹ / ₈
c	2 ¹ / ₄	2 ¹ / ₁₆	2 ³ / ₄	3 ³ / ₁₆	3 ⁹ / ₁₆	4 ¹ / ₈
d	1 ⁵ / ₁₆	1 ¹ / ₈	1 ³ / ₈	1 ³ / ₄	1 ¹⁵ / ₁₆	2 ¹ / ₁₆
e	3 ⁷ / ₁₆	3 ¹³ / ₁₆	4 ¹ / ₂	5	5 ⁷ / ₁₆	6 ³ / ₈

Condulet conduit bodies – cast iron or aluminum

Dimensions (in inches):

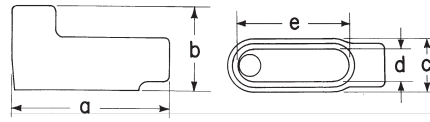

LB shape

Form 7 LB

Hub size	½"	¾"	1"	1¼"	1½"	2"	2½"	3"	3½"	4"
a	4 ⁹ / ₁₆	5 ³ / ₁₆	6	6½	7 ¹ / ₈	8 ¹ / ₈	10½	10½	12 ¹¹ / ₁₆	12 ¹¹ / ₁₆
b	2¼	2½	2 ⁷ / ₈	3 ⁵ / ₁₆	3 ¹¹ / ₁₆	4¼	5 ¹ / ₈	5 ⁷ / ₈	6 ⁹ / ₁₆	7 ¹ / ₁₆
c	1 ³ / ₈	1 ³ / ₁₆	1 ³ / ₄	2 ³ / ₁₆	2 ¹ / ₁₆	3	4¼	4¼	5¼	5¼
d	1 ⁵ / ₁₆	1 ¹ / ₈	1 ³ / ₈	1 ³ / ₄	1 ¹⁵ / ₁₆	2 ¹ / ₁₆	3 ³ / ₁₆	3 ³ / ₁₆	4½	4½
e	3 ³ / ₁₆	3 ¹³ / ₁₆	4½	5	5 ¹ / ₁₆	6 ⁷ / ₈	8 ¹ / ₈	8 ¹ / ₈	10¼	10¼

Form 8 LB

Hub size	½"	¾"	1"	1¼"	1½"	2"	2½"	3"	3½"	4"
a	4 ¹⁵ / ₁₆	5 ³ / ₁₆	6 ¹⁵ / ₃₂	7 ¹⁷ / ₃₂	9 ¹ / ₈	11	13 ¹⁵ / ₁₆	13 ¹⁵ / ₁₆	16 ¹ / ₈	16 ¹ / ₈
b	2 ⁷ / ₃₂	2 ¹ / ₁₆	2 ¹³ / ₁₆	3 ¹¹ / ₃₂	4 ¹ / ₃₂	4 ¹³ / ₁₆	6 ¹ / ₈	6 ¹ / ₂	7 ⁹ / ₁₆	7 ¹³ / ₁₆
c	1 ³ / ₈	1 ³ / ₁₆	1 ³ / ₄	2 ³ / ₁₆	2¼	3 ³ / ₄	5	5	6¼	6¼
d	1	1 ³ / ₁₆	1 ³ / ₈	1 ³ / ₄	2 ¹ / ₈	3	4¼	4¼	5 ¹ / ₁₆	5 ¹ / ₁₆
e	3 ³ / ₁₆	3 ¹⁵ / ₁₆	4 ⁹ / ₁₆	5 ⁵ / ₁₆	6½	8 ⁷ / ₁₆	10 ¹ / ₈	10 ¹ / ₈	13 ¹ / ₁₆	13 ¹ / ₁₆

Mark 9 LB

Hub size	½"	¾"	1"	1¼"	1½"	2"	2½"	3"	3½"	4"
a	4 ¹⁹ / ₃₂	5¼	6 ³ / ₃₂	7 ³ / ₃₂	7 ²⁵ / ₃₂	10 ³ / ₃₂	13 ¹⁵ / ₁₆	13 ¹⁵ / ₁₆	16 ¹ / ₈	16 ¹ / ₈
b	2 ⁷ / ₈	2 ¹⁵ / ₃₂	2 ¹³ / ₁₆	3 ⁵ / ₈	3 ⁷ / ₈	4 ¹⁹ / ₃₂	6 ¹ / ₈	6 ¹ / ₂	7 ⁹ / ₁₆	7 ⁹ / ₁₆
c	1 ³ / ₈	1 ¹⁹ / ₃₂	1 ³ / ₄	2 ³ / ₁₆	2½	3 ⁷ / ₃₂	5	5	6¼	6¼
d	1 ¹ / ₁₆	1 ⁹ / ₃₂	1 ¹ / ₁₆	1 ⁷ / ₈	2 ¹ / ₁₆	2 ²⁹ / ₃₂	4¼	4¼	5 ¹ / ₁₆	5 ¹ / ₁₆
e	3 ⁹ / ₃₂	3 ²⁷ / ₃₂	4 ⁹ / ₁₆	5 ³ / ₁₆	5 ¹ / ₈	8 ³ / ₃₂	10 ¹ / ₈	10 ¹ / ₈	13 ¹ / ₁₆	13 ¹ / ₁₆

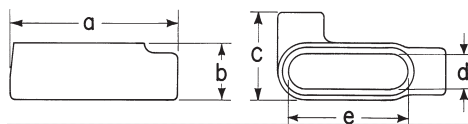

LL shape

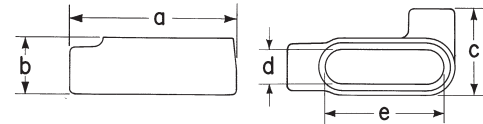

LR shape

Form 7 LL & LR

Hub size	½"	¾"	1"	1¼"	1½"	2"	2½"	3"	3½"	4"
a	4 ⁹ / ₁₆	5 ³ / ₁₆	6	6½	7 ¹ / ₈	8 ¹ / ₈	10½	10½	12 ¹¹ / ₁₆	12 ¹¹ / ₁₆
b	1 ³ / ₈	1 ³ / ₁₆	1 ⁷ / ₈	2 ¹ / ₁₆	2 ¹ / ₁₆	3 ¹ / ₈	3 ³ / ₈	4 ⁷ / ₈	4 ⁷ / ₈	5 ¹ / ₈
c	2¼	2 ¹ / ₁₆	2 ³ / ₄	3 ⁵ / ₁₆	3 ³ / ₁₆	4 ¹ / ₈	5¼	5¼	6 ¹⁵ / ₁₆	6 ¹⁵ / ₁₆
d	1 ⁵ / ₁₆	1 ¹ / ₈	1 ³ / ₈	1 ³ / ₄	1 ¹⁵ / ₁₆	2 ¹ / ₁₆	3 ³ / ₁₆	3 ³ / ₁₆	4½	4½
e	3 ³ / ₁₆	3 ¹³ / ₁₆	4½	5	5 ¹ / ₁₆	6 ⁷ / ₈	8 ¹ / ₈	8 ¹ / ₈	10¼	10¼

Form 8 LL & LR

Hub size	½"	¾"	1"	1¼"	1½"	2"	2½"	3"
a	4 ¹⁵ / ₁₆	5 ³ / ₁₆	6 ¹⁵ / ₃₂	7 ¹⁷ / ₃₂	9 ¹ / ₈	11	13 ¹⁵ / ₁₆	13 ¹⁵ / ₁₆
b	1 ¹ / ₁₆	1 ¹¹ / ₁₆	1 ¹⁵ / ₁₆	2 ¹ / ₈	2 ²⁹ / ₃₂	3 ¹ / ₁₆	4 ¹ / ₁₆	4 ¹³ / ₁₆
c	2 ² / ₃₂	2 ³ / ₁₆	2 ⁵ / ₈	3 ⁵ / ₃₂	4	5	6 ¹¹ / ₁₆	6 ¹¹ / ₁₆
d	1	1 ³ / ₁₆	1 ³ / ₈	1 ³ / ₄	2 ¹ / ₈	3	4¼	4¼
e	3 ³ / ₁₆	3 ¹⁵ / ₁₆	4 ⁹ / ₁₆	5 ⁵ / ₁₆	6½	8 ⁷ / ₁₆	10 ¹ / ₈	10 ¹ / ₈

Mark 9 LL & LR

Hub size	½"	¾"	1"	1¼"	1½"	2"	2½"	3"	3½"	4"
a	4 ¹⁹ / ₃₂	5¼	6 ³ / ₃₂	7 ³ / ₃₂	7 ⁵¹ / ₆₄	10 ³ / ₃₂	13 ¹⁵ / ₁₆	13 ¹⁵ / ₁₆	16 ¹ / ₈	16 ¹ / ₈
b	1 ¹³ / ₃₂	1 ⁵ / ₈	1 ⁷ / ₈	2 ¹ / ₂	2 ³ / ₁₆	3 ¹ / ₁₆	4 ¹ / ₁₆	4 ¹⁹ / ₁₆	5 ¹¹ / ₁₆	5 ¹³ / ₁₆
c	2 ¹ / ₈	2 ⁵ / ₁₆	2 ¹ / ₁₆	3¼	3½	4 ¹³ / ₆₄	6 ¹¹ / ₁₆	6 ¹ / ₁₆	8 ¹ / ₈	8 ¹ / ₈
d	1 ¹ / ₁₆	1¼	1 ³ / ₈	1 ³ / ₄	2 ¹ / ₁₆	2 ²⁹ / ₃₂	4¼	4¼	5 ¹ / ₁₆	5 ¹ / ₁₆
e	3 ⁹ / ₃₂	3 ²⁷ / ₃₂	4 ⁹ / ₁₆	5 ³ / ₁₆	5 ¹ / ₈	8 ³ / ₃₂	10 ¹ / ₈	10 ¹ / ₈	13 ¹ / ₁₆	13 ¹ / ₁₆

Condulet conduit bodies – cast iron or aluminum

Dimensions (in inches):

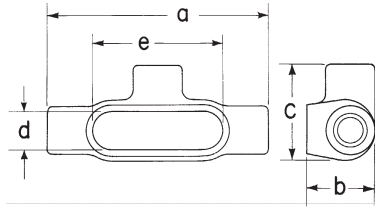

T shape

Form 7 T

Hub size	a	b	c	d	e
1/2"	5 ⁵ / ₈	1 ³ / ₄	2 ⁷ / ₁₆	1 ⁵ / ₁₆	3 ⁷ / ₁₆
3/4"	6 ¹ / ₄	2	2 ⁵ / ₈	1 ¹ / ₈	3 ¹³ / ₁₆
1"	7 ¹ / ₄	2 ¹ / ₄	3	1 ³ / ₈	4 ¹ / ₂
1 1/4"	7 ⁷ / ₁₆	2 ⁵ / ₁₆	3 ³ / ₁₆	1 ³ / ₄	5
1 1/2"	8 ³ / ₁₆	2 ⁹ / ₁₆	3 ⁹ / ₁₆	1 ¹⁵ / ₁₆	5 ¹ / ₁₆
2"	9 ³ / ₁₆	3 ³ / ₈	4 ¹ / ₈	2 ¹ / ₁₆	6 ³ / ₈
2 1/2"	12	3 ³ / ₈	5 ¹ / ₄	3 ⁷ / ₁₆	8 ⁷ / ₈
3"	12 ¹ / ₁₆	4 ³ / ₈	5 ¹ / ₄	3 ⁹ / ₁₆	8 ⁷ / ₈
3 1/2"	14 ⁷ / ₁₆	4 ⁷ / ₈	6 ¹⁵ / ₁₆	4 ¹ / ₂	10 ¹ / ₄
4"	14 ⁹ / ₁₆	5 ³ / ₈	6 ¹⁵ / ₁₆	4 ¹ / ₂	10 ¹ / ₄

Form 8 T

Hub size	a	b	c	d	e
1/2"	5 ¹¹ / ₁₆	1 ³ / ₄	2 ⁹ / ₃₂	1	3 ⁹ / ₁₆
3/4"	6 ⁹ / ₃₂	2	2 ⁹ / ₁₆	1 ¹ / ₁₆	3 ¹⁵ / ₁₆
1"	7 ⁷ / ₁₆	2 ¹ / ₄	2 ⁹ / ₈	1 ³ / ₈	4 ⁷ / ₁₆
1 1/4"	8 ¹ / ₂	2 ⁵ / ₈	3 ⁵ / ₃₂	1 ³ / ₄	5 ⁵ / ₁₆
1 1/2"	10 ³ / ₈	2 ²⁵ / ₃₂	4	2 ¹ / ₈	6 ¹ / ₂
2"	12 ¹ / ₄	3 ⁹ / ₁₆	5	3	8 ⁷ / ₁₆
2 1/2"	15 ⁵ / ₈	4 ¹ / ₁₆	6 ¹¹ / ₁₆	4 ¹ / ₄	10 ⁷ / ₈
3"	15 ⁵ / ₈	4 ¹³ / ₁₆	6 ¹¹ / ₁₆	4 ¹ / ₄	10 ⁷ / ₈

Mark 9 T

Hub size	a	b	c	d	e
1/2"	5	1 ¹³ / ₃₂	2 ¹ / ₈	1 ¹ / ₁₆	3 ⁹ / ₃₂
3/4"	5 ¹¹ / ₁₆	1 ⁵ / ₈	2 ⁵ / ₁₆	1 ¹ / ₄	3 ²⁷ / ₃₂
1"	6 ¹⁹ / ₃₂	1 ⁷ / ₈	2 ¹¹ / ₁₆	1 ³ / ₈	4 ⁷ / ₁₆
1 1/4"	7 ⁷ / ₈	2 ¹ / ₂	3 ¹ / ₄	1 ⁷ / ₈	5 ¹ / ₁₆
1 1/2"	8 ¹¹ / ₃₂	2 ¹³ / ₁₆	3 ¹ / ₂	2 ¹ / ₁₆	5 ⁷ / ₈
2"	10 ³ / ₈	3 ¹ / ₁₆	4 ¹³ / ₃₂	2 ²⁹ / ₃₂	8 ⁷ / ₃₂
2 1/2"	15 ⁵ / ₈	4 ⁷ / ₁₆	6 ¹¹ / ₁₆	4 ¹ / ₄	10 ⁷ / ₈
3"	15 ⁵ / ₈	4 ¹³ / ₁₆	6 ¹¹ / ₁₆	4 ¹ / ₄	10 ⁷ / ₈
3 1/2"	18 ⁷ / ₄	5 ¹¹ / ₁₆	8 ⁷ / ₈	5 ¹ / ₁₆	13 ¹ / ₁₆
4"	18 ⁷ / ₄	5 ¹⁵ / ₁₆	8 ⁷ / ₈	5 ¹ / ₁₆	13 ¹ / ₁₆

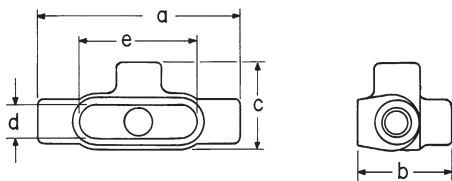

TA shape

Form 7 TA

Hub size	a	b	c	d	e
1/2"	5 ⁵ / ₈	2 ⁵ / ₈	2 ⁷ / ₁₆	1 ⁵ / ₁₆	3 ⁷ / ₁₆
3/4"	6 ¹ / ₄	2 ¹ / ₈	2 ⁵ / ₈	1 ¹ / ₈	3 ¹³ / ₁₆
1"	7 ¹ / ₄	3 ¹ / ₄	3	1 ³ / ₈	4 ¹ / ₂
1 1/4"	7 ⁷ / ₁₆	3 ⁵ / ₁₆	3 ³ / ₁₆	1 ³ / ₄	5
1 1/2"	8 ³ / ₁₆	3 ¹¹ / ₁₆	3 ⁹ / ₁₆	1 ¹⁵ / ₁₆	5 ¹ / ₁₆
2"	9 ³ / ₁₆	4 ¹ / ₄	4 ¹ / ₈	2 ¹ / ₁₆	6 ³ / ₈

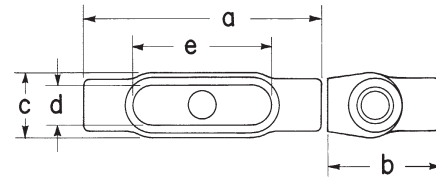

TB shape

Form 7 TB

Hub size	a	b	c	d	e
1/2"	5 ⁵ / ₈	2 ⁵ / ₈	1 ⁹ / ₁₆	1 ⁵ / ₁₆	3 ⁷ / ₁₆
3/4"	6 ¹ / ₄	2 ¹ / ₈	1 ³ / ₄	1 ¹ / ₈	3 ¹³ / ₁₆
1"	7 ¹ / ₄	3 ¹ / ₄	2	1 ³ / ₈	4 ¹ / ₂
1 1/4"	7 ⁷ / ₁₆	3 ⁵ / ₁₆	2 ³ / ₁₆	1 ³ / ₄	5
1 1/2"	8 ³ / ₁₆	5	2 ¹ / ₁₆	1 ¹⁵ / ₁₆	5 ¹ / ₁₆
2"	9 ³ / ₁₆	6 ¹ / ₈	3	2 ¹ / ₁₆	6 ³ / ₈

Form 8 TB

Hub size	a	b	c	d	e
1/2"	5 ¹¹ / ₁₆	2 ¹⁷ / ₃₂	1 ³ / ₈	1	3 ⁹ / ₁₆
3/4"	6 ⁹ / ₃₂	2 ³ / ₄	1 ⁹ / ₁₆	1 ³ / ₁₆	3 ¹⁵ / ₁₆
1"	7 ⁷ / ₁₆	3 ¹ / ₈	1 ³ / ₄	1 ³ / ₈	4 ⁷ / ₁₆
1 1/4"	8 ¹ / ₂	3 ¹¹ / ₃₂	2 ³ / ₁₆	1 ³ / ₄	5 ⁵ / ₁₆
1 1/2"	10 ³ / ₈	4 ¹ / ₃₂	2 ¹ / ₄	2 ¹ / ₈	6 ¹ / ₂
2"	12 ¹ / ₄	4 ¹³ / ₁₆	3 ³ / ₄	3	8 ⁷ / ₁₆

Mark 9 TB

Hub size	a	b	c	d	e
1/2"	5 ¹¹ / ₁₆	2 ³³ / ₆₄	1 ³ / ₈	1	3 ⁹ / ₁₆
3/4"	6 ⁹ / ₁₆	2 ¹ / ₈	1 ⁹ / ₁₆	1 ³ / ₁₆	3 ¹⁵ / ₁₆
1"	7 ⁷ / ₁₆	3 ¹ / ₈	1 ³ / ₄	1 ³ / ₈	4 ⁷ / ₁₆
1 1/4"	8 ¹ / ₂	3 ¹¹ / ₃₂	2 ³ / ₁₆	1 ³ / ₄	5 ⁵ / ₁₆
1 1/2"	8 ¹¹ / ₃₂	3 ¹ / ₈	2 ¹ / ₂	2 ³ / ₁₆	5 ⁷ / ₈
2"	10 ⁷ / ₈	4 ¹⁵ / ₃₂	3 ¹ / ₃₂	2 ¹³ / ₁₆	8 ⁷ / ₃₂

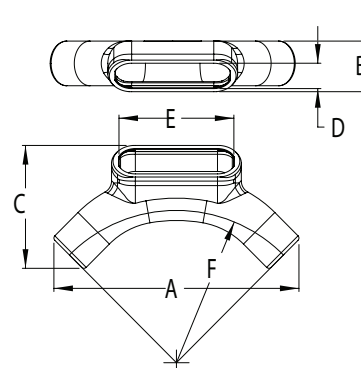

U shape

Form 7 U

Hub size	A	B	C	D	E	F (bend radius)
1/2"	7 ¹ / ₈	1 ¹ / ₂	3 ¹¹ / ₁₆	1 ⁵ / ₁₆	3 ⁷ / ₁₆	4.4
3/4"	7 ¹ / ₂	1 ¹¹ / ₁₆	3 ⁷ / ₈	1 ¹ / ₈	3 ¹³ / ₁₆	4.6
1"	9 ¹¹ / ₁₆	2	4 ¹³ / ₁₆	1 ³ / ₈	4 ¹ / ₂	6.0
1 1/4"	12	2 ¹ / ₂	5 ¹⁵ / ₁₆	1 ³ / ₄	5	7.4
1 1/2"	15 ⁵ / ₈	2 ⁷ / ₈	7 ³ / ₁₆	1 ¹⁵ / ₁₆	5 ¹ / ₁₆	9.6
2"	17 ⁹ / ₁₆	3 ³ / ₈	8 ³ / ₈	2 ¹ / ₁₆	6 ³ / ₈	10.9

Condulet conduit bodies – cast iron or aluminum

Dimensions (in inches):

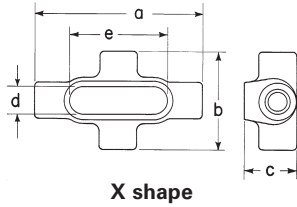

Form 7 X

Hub size	a	b	c	d	e
1/2"	5 ⁵ / ₈	3 ⁵ / ₁₆	1 ³ / ₄	1 ⁵ / ₁₆	3 ³ / ₁₆
3/4"	6 ¹ / ₄	3 ¹ / ₂	2	1 ¹ / ₈	3 ¹³ / ₁₆
1"	7 ¹ / ₄	4	2 ¹ / ₄	1 ³ / ₈	4 ¹ / ₂
1 1/4"	7 ⁷ / ₁₆	4 ¹ / ₈	2 ⁵ / ₁₆	1 ³ / ₄	5
1 1/2"	8 ³ / ₁₆	4 ⁵ / ₈	2 ³ / ₁₆	1 ¹⁵ / ₁₆	5 ⁷ / ₁₆
2"	9 ³ / ₁₆	5 ³ / ₁₆	3 ³ / ₈	2 ⁷ / ₁₆	6 ³ / ₈

Form 8 X

Hub size	a	b	c	d	e
1/2"	5 ¹¹ / ₁₆	2 ²⁹ / ₃₂	1 ³ / ₄	1	3 ⁷ / ₁₆
3/4"	6 ⁹ / ₃₂	3 ¹ / ₁₆	2	1 ³ / ₁₆	3 ¹⁵ / ₁₆
1"	7 ³ / ₁₆	3 ¹ / ₂	2 ¹ / ₄	1 ³ / ₈	4 ⁹ / ₁₆
1 1/4"	8 ¹ / ₂	4 ¹ / ₈	2 ⁵ / ₈	1 ³ / ₄	5 ⁷ / ₁₆
1 1/2"	10 ³ / ₈	5 ¹ / ₄	2 ¹⁵ / ₃₂	2 ¹ / ₈	6 ¹ / ₂
2"	12 ¹ / ₄	6 ¹ / ₄	3 ³ / ₁₆	3	8 ³ / ₁₆

Mark 9 X

Hub size	a	b	c	d	e
1/2"	5 ¹¹ / ₁₆	2 ⁵⁷ / ₆₄	1 ³ / ₄	1	3 ⁷ / ₁₆
3/4"	6 ⁹ / ₁₆	3 ¹ / ₄	2	1 ³ / ₁₆	3 ¹⁵ / ₁₆
1"	7 ⁵ / ₁₆	3 ¹ / ₂	2 ¹ / ₄	1 ³ / ₈	4 ⁹ / ₁₆