



KT-LED100HID-EX39-840-D /G2

HID REPLACEMENT LED LAMP

DESCRIPTION

100W HID Replacement LED Lamp | 4000K | > 80 CRI



LAMP TYPE: HID Replacement LED
BASE TYPE: EX39 (Mogul)
WATTAGE: 100W
COLOR TEMPERATURE: 4000K
METAL HALIDE EQUIVALENT: 400W
COLOR RENDERING INDEX (CRI): > 80
WARRANTY: 5 Years



PRODUCT FEATURES

- Replacement for conventional metal halide lamp
- 50,000+ hour lifetime
- Environmentally friendly: no mercury used
- Instant startup
- UL Listed, DLC Listed
- Operating temperature range: -30°C to 60°C / -22°F to 140°F.
- Exceeding 30°C / 86°F in fully enclosed fixtures will engage active cooling and power de-rating to ensure full product lifetime
- Active cooling technology: When internal thermal sensor is engaged, lamp power reduces to 80% of max; when sensor cools, lamp powers back up to 100% rated power
- Integral driver, eliminates the need for external driver or ballast; includes 6kV surge protection
- IP64 Rated; integrated heat sink quickly dissipates heat and guides water intrusion out of the lamp
- Lamp includes safety tether for additional security when installing lamp in luminaire
- Suitable for use in fully enclosed fixture. Minimum lamp compartment dimensions: 9.8in x 9.8in x 11.5in
- Do not use with standard dimmers. Not compatible with phase dimmers. Dimming functions with sensors only

OPERATING SPECIFICATIONS

ELECTRICAL CHARACTERISTICS

Input Voltage	Power Consumption	Power Factor	Input Current
120-277Vac	100W	>0.9	0.93A @ 120V 0.40A @ 277V

PHOTOMETRIC CHARACTERISTICS

Color Temperature (CCT)	4000K
Luminous Flux*	14,800 lm
Color Rendering Index (CRI)	>80
Efficacy	148 lm/W
Visible Light Area	360°

RATED LIFE

L70 (Hours)	50,000
-------------	--------

* Based off of total lamp lumens

SPECTRAL DISTRIBUTION

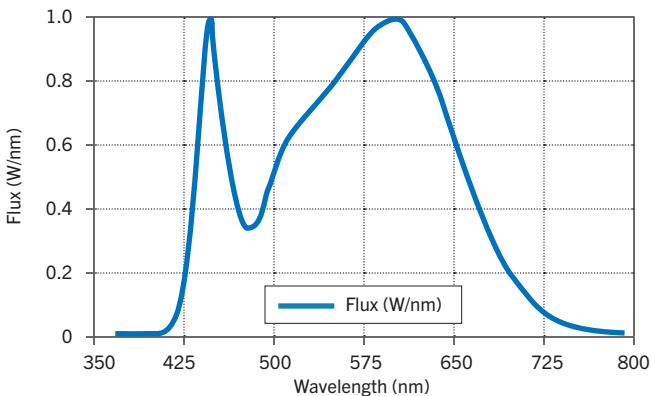

SMART PORT LED COMPATIBLE



On the top of the lamp is a low-voltage AUX port for Smart Port LED sensors. See *Accessories* for available sensor options.



KT-LED100HID-EX39-840-D /G2

HID REPLACEMENT LED LAMP

SMART PORT LED



On the top of the lamp is a low-voltage AUX port for lamp level sensor controls.

SMART PORT LED AUX SENSORS

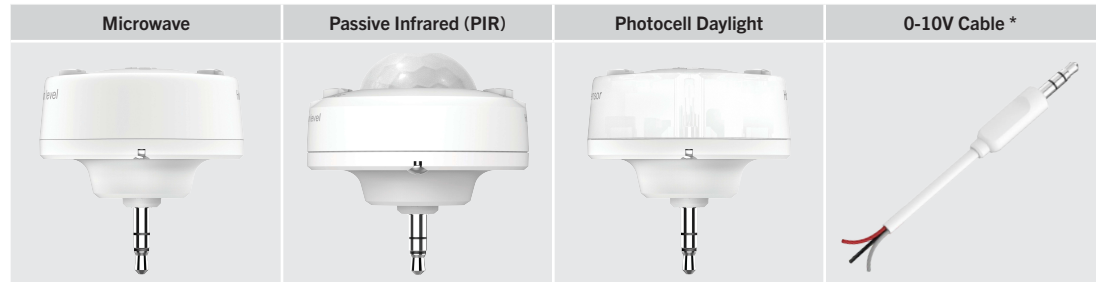

* For use with continuous dimming applications.

WIRING INSTRUCTIONS

STEP 1

Disconnect power. Disconnect and remove existing ballast, capacitor, and/or ignitor (where applicable) from fixture.

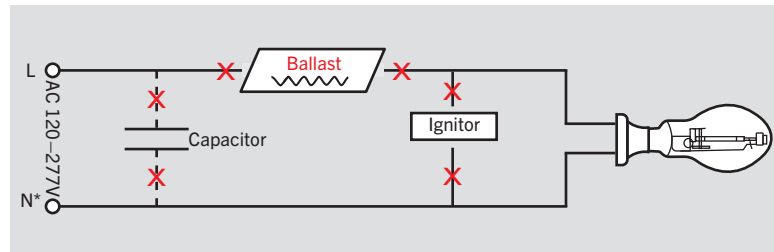

STEP 2

Rewire for line voltage to the lamp socket. Lamp is compatible with 120-277V from single phase, three phase wye, and three phase delta systems.

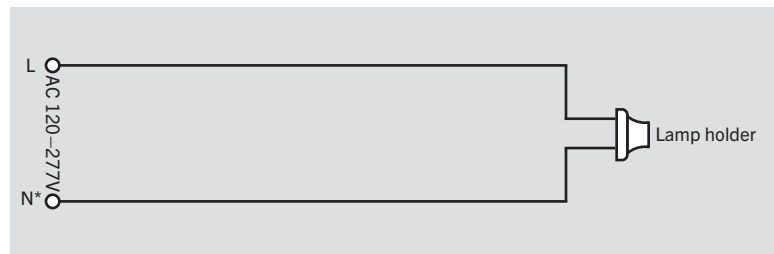

STEP 3

Install new LED replacement lamp. Ensure lamp is operating properly when power is turned on.

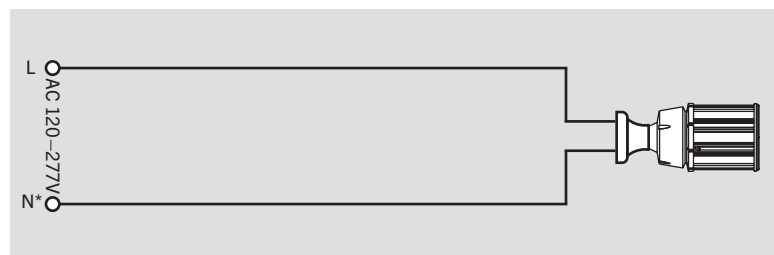
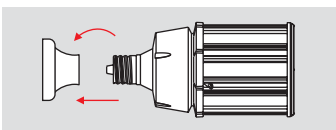

*or other line for certain three phase systems such as 120/208 three phase wye systems

EX39-based lamps will work in *both* **E39** and **EX39** sockets.

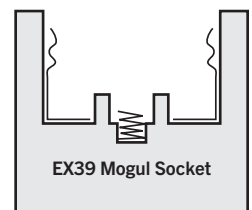
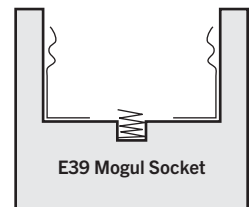



KT-LED100HID-EX39-840-D /G2

HID REPLACEMENT LED LAMP

PHYSICAL CHARACTERISTICS

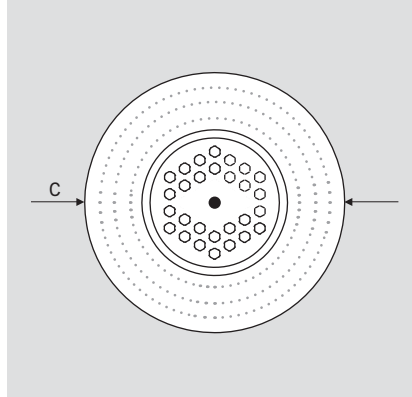
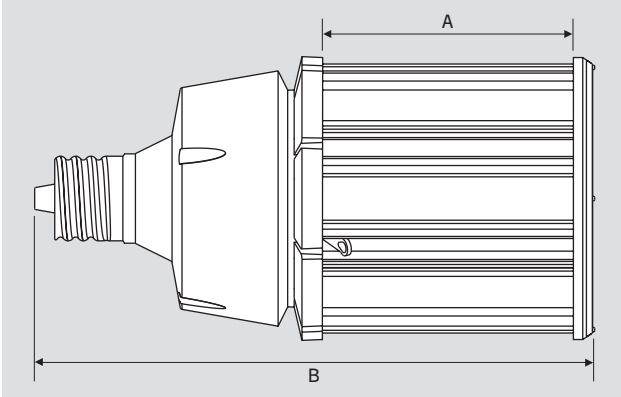

LAMP DIMENSIONS

A (Illuminated Length)	4.50"
B (Body Length)	10.32"
C (Diameter)	5.12"

BASE TYPE: EX39 (Mogul)

ACCESSORIES (SOLD SEPARATELY)

Catalog Number	Description
KTS-MW1-12V-AUX	SmartPort LED Microwave Occupancy sensor: On/Off with adjustable standby dimming level; 12V input
KTS-PIR1-12V-AUX	SmartPort LED PIR Occupancy sensor: On/Off with adjustable standby dimming level; 12V input
KTS-PS1-12V-AUX	SmartPort LED Photocell: On/Off with adjustable daylight threshold and timing; 12V input

ORDERING INFORMATION

ORDER CODE	PACK QTY.	EASY CODE	UPC	DLC PRODUCT ID
KT-LED100HID-EX39-840-D /G2-DP	16	LTN-77	843654121222	PL7SMIGOV2SA

CATALOG NUMBER BREAKDOWN

KT-LED100HID-EX39-840-D /G2

- 1
- 2
- 3
- 4
- 5
- 6
- 7
- 8
- 9
- 10

- 1 Keystone Technologies
- 2 LED Lamp
- 3 Wattage
- 4 Lamp Type
- 5 Base Type
- 6 800 Series
- 7 Color Temperature
- 8 Direct-Drive Series
- 9 Second Generation
- 10 Sensor Options

10 Sensor Options

	No Option
/PIR	PIR Occupancy Sensor included
/MW	Microwave Occupancy Sensor included
/PS	Photocell Sensor Included