

DESCRIPTION

Ideal for task, accent, office, cove, and utility, under and above cabinet lighting display, the Halo Undercabinet low-profile design delivers maximum energy savings with easy installation. The integrated universal driver design allows operation across a range of 120 to 277 volts and each fixture is equipped with a seleCCTable switch that allows users to customize color temperature. Fixtures are available in 9", 18", 24", 36" and 48" lengths with White and Matte Black finishes. To deliver added energy savings and increased utility, the HU30 also offers either a motion sensor or a USB port option for units 18 inch or larger. Each unit has an integrated on-off switch and offers smooth dimming down to 5% using a standard dimmer*. Multiple wiring options make installation a simple task. The HU30 also boasts a Minimum Color Rendering Index (CRI) of 90 in 2700K, 3000K, 3500K and 4000K color temperatures.

Catalog #		Type	
Project			
Comments		Date	
Prepared by			

SPECIFICATION FEATURES

Even Light Distribution

Specialized optical system consisting of tightly clustered proximity phosphor LEDs, advanced optical chamber coatings and lens materials resulting in soft illumination with high efficiency. These fixtures are ideal for task lighting over glossy surfaces with no distracting shadow patterns.

Color Temperature

4 position external SeleCCTable color temperature switch allows users to choose between 2700K, 3000K, 3500K and 4000K and adjust per their lighting needs.

PIR Motion Sensor

The PIR technology based motion sensor allows for fixture on/off to be managed based on movement detection. See table for detection distance. At time of installation, the sensor can be configured to vacancy or occupancy functionality as well as to control multiple fixtures connected together.***

USB Port

The USB output supplies 5V 0.5A and is useful for charging many smart devices and accessories requiring a USB input. Note that the USB power supply is integrated into the fixture and charging performance will be affected by the use of a dimmer.

Wiring Flexibility

Use any combination of three different wiring methods: Bring flexible conduit or Romex directly to either end or back of any size fixture. Conduit connector and romex strain relief hardware is included with each fixture. Otherwise users can utilize the available plug in connectors (sold separately) to link additional fixtures to the circuit (See instructions sheets for more detail).** Link any combination of fixtures up to 450 W total load using available connectors.

Durable Low Profile Housing

Extruded aluminum housing and color matched end caps with a sleek over all height of 3/4".

Mounting

Each unit is secured directly to the mounting surface with just two fasteners keeping installation costs and efforts low. Can be mounted in horizontal and vertical orientations.

Optional Accessories

Optional splice box has a connection port on each side to allow for runs in either or both directions. Includes Romex/ 1/2" conduit connector. Various connector cable options and lengths provide flexibility of mounting location.

Finish Options

Fixtures and accessories are available in both White (P) and Matte Black (MB) finishes.

Electronic Driver & Dimming

Universal Voltage (120-277V, 50/60Hz) Electronic driver provides flicker free light output and noise free operation. Designed for continuous dimming (ELV or TRIAC) down to 5% at 120V with compatible dimmers.*

Compliance & Certifications

- cULus listed
- Can be used to meet IECC, ASHRAE commercial and residential standards
- FCC
- Damp location listed
- Closet rated

Factory Defaults

The fixtures will be set to the following default where applicable:
CCT: 3000K

Motion sensor configuration:

- Occupancy
- Motion sensor time out: 8 minutes
- Pass through control: ON

Mounting Height H (ft)	Maximum Detection Distance ⁴ X (ft)
2	3
4	6
6	10

⁴ Actual detection distance may vary based on multiple factors including but not limited to angle of moving object and reflectivity of surrounding surfaces. Table is provided for guidance purposes only.

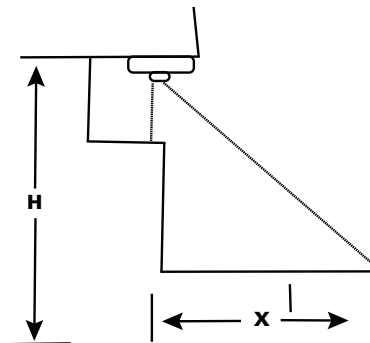

* See our website for dimming guidance information. www.eaton.com/lighting

** Plug in wire option is only available on either end (side) of the fixture. Back wire option is for romex or flexible conduit wiring only.

*** For the motion sensor to operate under vacancy functionality, the fixtures will need to be wired to a master switch or wall dimmer. Motion sensor control settings are not readily accessible after installation is complete. For details please refer to installation instructions.



HU30

Premium LED Undercabinet



seleCCTable

selectable color temp
2700K, 3000K, 3500K, 4000K



USB



PIR

motion sensor

ENERGY DATA

Power Factor: >0.98
THD: <20%
Color Temperature: SeleCCTable
2700K, 3000K, 3500K, 4000K
Color Rendering Index: 90
Nominal Lumens/Ft: 300

seleCCTable™



Can be used to comply with California Title 24 High Efficacy requirements. Certified to California Appliance Efficiency Database under JAB.

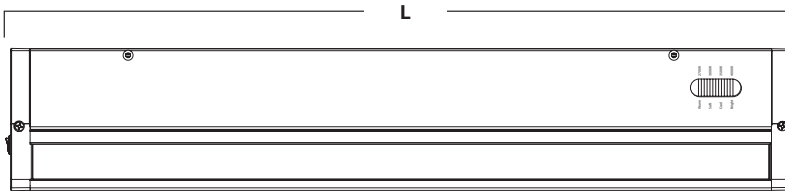

Size Description	9 in. Nominal	18 in. Nominal	24 in. Nominal	36 in. Nominal	48 in. Nominal
Length "L"	8.98" [228.1mm]	16.55" [420.4mm]	23.98" [609.1mm]	32.44" [824mm]	47.18" [1,198.4mm]
Wattage	3.7	8.2	11.1	14.2	21.4
Lumens	222	440	627	844	1253

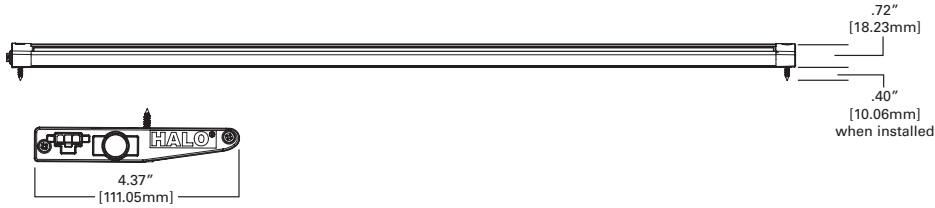

ORDERING INFORMATION

SAMPLE NUMBER: HU30ADV24P (24 inch Dimmable fixture, 90 CRI, SeleCCTable Color temperature, Motion sensor, White Finish)

Family	Configuration ¹ / Color Temp	Length ²	Finish
HU30 =Halo premium undercabinet	SCT =Selectable CCT only (limited to 9 inch) BSC =Selectable CCT + USB (Basic) ADV =Selectable CCT + PIR Sensor (Advanced)	09 =9" 18 =18" 24 =24" 36 =36" 48 =48"	P =White MB =Matte Black

- PIR sensor & USB port not offered together in a standard configuration.
- 9 in. SKU is only offered in SCT configuration.

CONNECTORS & ACCESSORIES



HU101
3" Daisy Chain Connector



HU102
6" Daisy Chain Connector

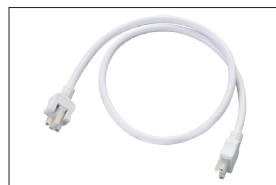

HU1010
12" Daisy Chain Connector



HU1011
18" Daisy Chain Connector

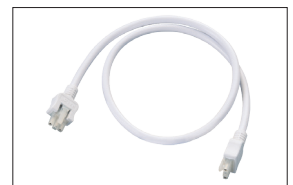

HU103
24" Daisy Chain Connector

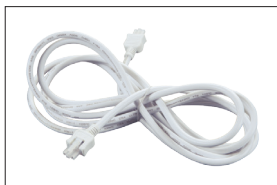

HU104
120" Daisy Chain Connector

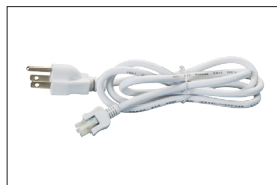

HU105
48" Power Cord - 120V only



HU109
Splice Box



HU107
1-1/2" Male-to-Male Connector

Finish: **P** = White; **MB** = Matte Black **Example:** HU101P = 3" Daisy Chain Connector, White

PHOTOMETRY

Fixture Application Illustration

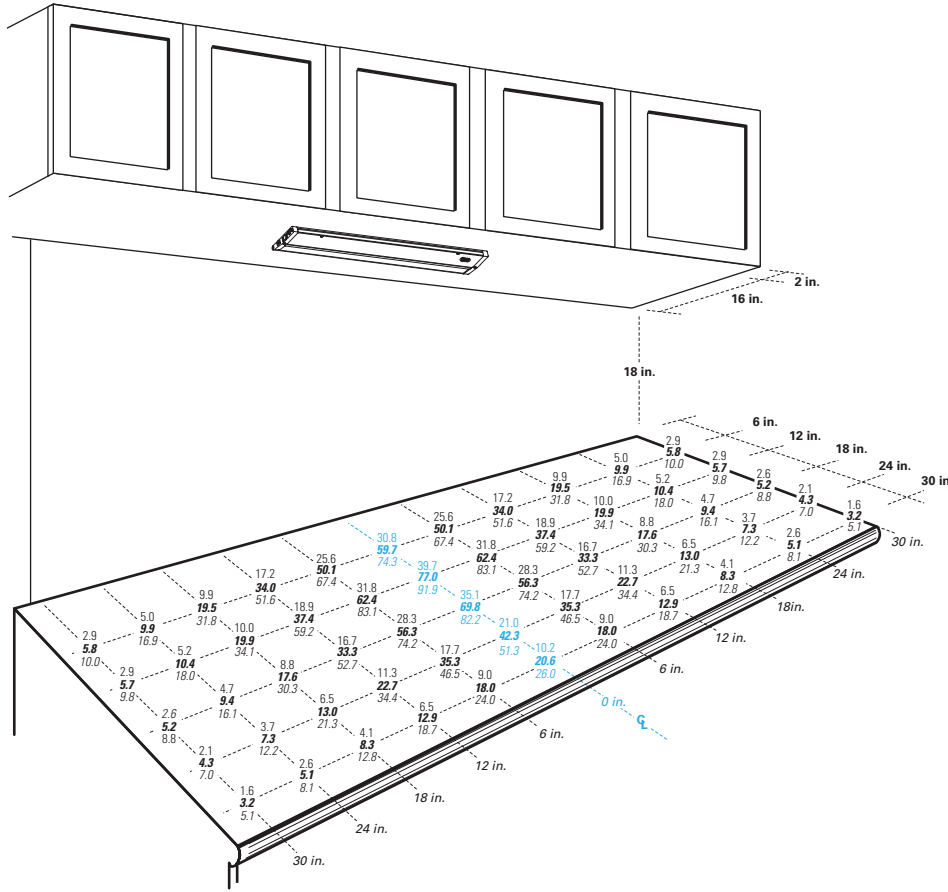

MOUNTING HEIGHT 18"

Top Number Report: HU30SCT09P.IES

Middle Number Report: HU30BSC18P.IES

Bottom Number Report: HU30BSC24P.IES

Countertop 60" x 30"

Diagram not to scale.

18" Mounting Height

Top Number Report - HU30SCT09P

Middle Number Report - HU30BSC18P

Bottom Number Report - HU30BSC24P

Width											Length
30in	24in	18in	12in	6in	0in	6in	12in	18in	24in	30in	
2.9	5.0	9.9	17.2	25.6	30.8	25.6	17.2	9.9	5.0	2.9	6 in
5.8	9.9	19.5	34.0	50.1	59.7	50.1	34.0	19.5	9.9	5.8	
10.0	16.9	31.8	51.6	67.4	74.3	67.4	51.6	31.8	16.9	10.0	
2.9	5.2	10.0	18.9	31.8	39.7	31.8	18.9	10.0	5.2	2.9	12 in
5.7	10.4	19.9	37.4	62.4	77.0	62.4	37.4	19.9	10.4	5.7	
9.8	18.0	34.1	59.2	83.1	91.9	83.1	59.2	34.1	18.0	9.8	
2.6	4.7	8.8	16.7	28.3	35.1	28.3	16.7	8.8	4.7	2.6	18 in
5.2	9.4	17.6	33.3	56.3	69.8	56.3	33.3	17.6	9.4	5.2	
8.8	16.1	30.3	52.7	74.2	82.2	74.2	52.7	30.3	16.1	8.8	
2.1	3.7	6.5	11.3	17.7	21.0	17.7	11.3	6.5	3.7	2.1	24 in
4.3	7.3	13.0	22.7	35.3	42.3	35.3	22.7	13.0	7.3	4.3	
7.0	12.2	21.3	34.4	46.5	51.3	46.5	34.4	21.3	12.2	7.0	
1.6	2.6	4.1	6.5	9.0	10.2	9.0	6.5	4.1	2.6	1.6	30 in
3.2	5.1	8.3	12.9	18.0	20.6	18.0	12.9	8.3	5.1	3.2	
5.1	8.1	12.8	18.7	24.0	26.0	24.0	18.7	12.8	8.1	5.1	

15" Mounting Height

Top Number Report - HU30SCT09P

Middle Number Report - HU30BSC18P

Bottom Number Report - HU30BSC24P

Width											Length
30in	24in	18in	12in	6in	0in	6in	12in	18in	24in	30in	
2.4	4.2	8.9	17.1	28.5	36.4	28.5	17.1	8.9	4.2	2.4	6 in
4.7	8.4	17.8	33.8	56.0	70.4	56.0	33.8	17.8	8.4	4.7	
8.3	14.9	30.5	54.1	75.1	83.3	75.1	54.1	30.5	14.9	8.3	
2.3	4.5	9.3	20.1	40.3	55.3	40.3	20.1	9.3	4.5	2.3	12 in
4.7	8.9	18.5	39.9	79.4	107.4	79.4	39.9	18.5	8.9	4.7	
8.2	16.3	34.5	69.8	107.1	117.5	107.1	69.8	34.5	16.3	8.2	
2.1	4.0	8.1	17.7	35.6	48.3	35.6	17.7	8.1	4.0	2.1	18 in
4.2	7.9	16.3	35.4	71.0	96.5	71.0	35.4	16.3	7.9	4.2	
7.3	14.4	30.5	61.7	94.9	104.5	94.9	61.7	30.5	14.4	7.3	
1.7	3.0	5.7	11.1	19.3	24.3	19.3	11.1	5.7	3.0	1.7	24 in
3.4	6.0	11.5	22.2	38.6	48.9	38.6	22.2	11.5	6.0	3.4	
5.7	10.5	19.9	35.6	50.9	56.5	50.9	35.6	19.9	10.5	5.7	
1.2	2.0	3.4	5.6	8.4	9.7	8.4	5.6	3.4	2.0	1.2	30 in
2.5	4.0	6.8	11.3	16.8	19.7	16.8	11.3	6.8	4.0	2.5	
4.0	6.6	10.9	16.7	22.0	24.1	22.0	16.7	10.9	6.6	4.0	

DESCRIPTION

Ideal for task, accent, office, cove, and utility, under and above cabinet lighting display, the Halo Undercabinet low-profile design delivers maximum energy savings with easy installation. The integrated universal driver design allows operation across a range of 120 to 277 volts and each fixture is equipped with a seleCCTable switch that allows users to customize color temperature. Fixtures are available in 9", 18", 24", 36" and 48" lengths with White and Matte Black finishes. To deliver added energy savings and increased utility, the HU30 also offers either a motion sensor or a USB port option for units 18 inch or larger. Each unit has an integrated on-off switch and offers smooth dimming down to 5% using a standard dimmer*. Multiple wiring options make installation a simple task. The HU30 also boasts a Minimum Color Rendering Index (CRI) of 90 in 2700K, 3000K, 3500K and 4000K color temperatures.

Catalog #		Type	
Project			
Comments		Date	
Prepared by			

SPECIFICATION FEATURES

Even Light Distribution

Specialized optical system consisting of tightly clustered proximity phosphor LEDs, advanced optical chamber coatings and lens materials resulting in soft illumination with high efficiency. These fixtures are ideal for task lighting over glossy surfaces with no distracting shadow patterns.

Color Temperature

4 position external SeleCCTable color temperature switch allows users to choose between 2700K, 3000K, 3500K and 4000K and adjust per their lighting needs.

PIR Motion Sensor

The PIR technology based motion sensor allows for fixture on/off to be managed based on movement detection. See table for detection distance. At time of installation, the sensor can be configured to vacancy or occupancy functionality as well as to control multiple fixtures connected together.***

USB Port

The USB output supplies 5V 0.5A and is useful for charging many smart devices and accessories requiring a USB input. Note that the USB power supply is integrated into the fixture and charging performance will be affected by the use of a dimmer.

Wiring Flexibility

Use any combination of three different wiring methods: Bring flexible conduit or Romex directly to either end or back of any size fixture. Conduit connector and romex strain relief hardware is included with each fixture. Otherwise users can utilize the available plug in connectors (sold separately) to link additional fixtures to the circuit (See instructions sheets for more detail).** Link any combination of fixtures up to 450 W total load using available connectors.

Durable Low Profile Housing

Extruded aluminum housing and color matched end caps with a sleek over all height of 3/4".

Mounting

Each unit is secured directly to the mounting surface with just two fasteners keeping installation costs and efforts low. Can be mounted in horizontal and vertical orientations.

Optional Accessories

Optional splice box has a connection port on each side to allow for runs in either or both directions. Includes Romex/ 1/2" conduit connector. Various connector cable options and lengths provide flexibility of mounting location.

Finish Options

Fixtures and accessories are available in both White (P) and Matte Black (MB) finishes.

Electronic Driver & Dimming

Universal Voltage (120-277V, 50/60Hz) Electronic driver provides flicker free light output and noise free operation. Designed for continuous dimming (ELV or TRIAC) down to 5% at 120V with compatible dimmers.*

Compliance & Certifications

- cULus listed
- Can be used to meet IECC, ASHRAE commercial and residential standards
- FCC
- Damp location listed
- Closet rated

Factory Defaults

The fixtures will be set to the following default where applicable:
CCT: 3000K

Motion sensor configuration:

- Occupancy
- Motion sensor time out: 8 minutes
- Pass through control: ON

Mounting Height H (ft)	Maximum Detection Distance ⁴ X (ft)
2	3
4	6
6	10

⁴ Actual detection distance may vary based on multiple factors including but not limited to angle of moving object and reflectivity of surrounding surfaces. Table is provided for guidance purposes only.

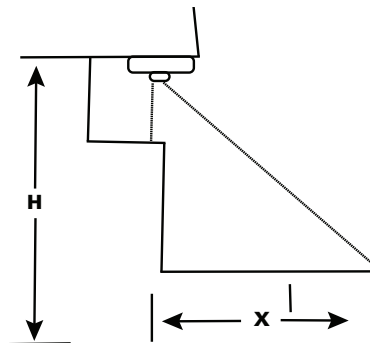

* See our website for dimming guidance information. www.eaton.com/lighting

** Plug in wire option is only available on either end (side) of the fixture. Back wire option is for romex or flexible conduit wiring only.

*** For the motion sensor to operate under vacancy functionality, the fixtures will need to be wired to a master switch or wall dimmer. Motion sensor control settings are not readily accessible after installation is complete. For details please refer to installation instructions.

HU30
Premium LED Undercabinet

seleCCTable
selectable color temp
2700K, 3000K, 3500K, 4000K

USB

PIR
motion sensor

ENERGY DATA
Power Factor: >0.98
THD: <20%
Color Temperature: SeleCCTable
2700K, 3000K, 3500K, 4000K
Color Rendering Index: 90
Nominal Lumens/Ft: 300

seleCCTable™

Can be used for
IECC
International Energy Conservation Code High Efficacy Compliance

Efficiency Standards
T24 California Title 24 Residential and Non-Residential Compliant

Can be used to comply with California Title 24 High Efficacy requirements. Certified to California Appliance Efficiency Database under JAB.

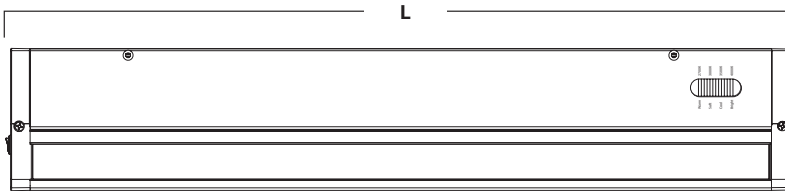

Size Description	9 in. Nominal	18 in. Nominal	24 in. Nominal	36 in. Nominal	48 in. Nominal
Length "L"	8.98" [228.1mm]	16.55" [420.4mm]	23.98" [609.1mm]	32.44" [824mm]	47.18" [1,198.4mm]
Wattage	3.7	8.2	11.1	14.2	21.4
Lumens	222	440	627	844	1253

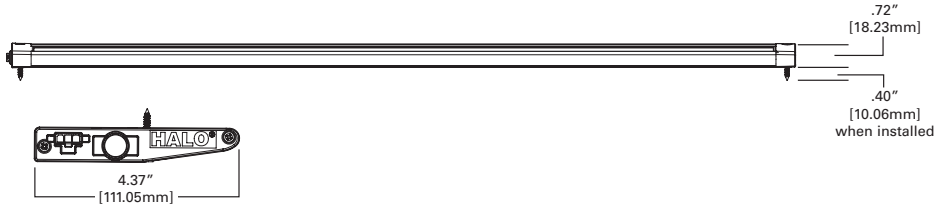

ORDERING INFORMATION

SAMPLE NUMBER: HU30ADV24P (24 inch Dimmable fixture, 90 CRI, SeleCCTable Color temperature, Motion sensor, White Finish)

Family	Configuration ¹ / Color Temp	Length ²	Finish
HU30 =Halo premium undercabinet	SCT =Selectable CCT only (limited to 9 inch) BSC =Selectable CCT + USB (Basic) ADV =Selectable CCT + PIR Sensor (Advanced)	09 =9" 18 =18" 24 =24" 36 =36" 48 =48"	P =White MB =Matte Black

- PIR sensor & USB port not offered together in a standard configuration.
- 9 in. SKU is only offered in SCT configuration.

CONNECTORS & ACCESSORIES



HU101
3" Daisy Chain Connector



HU102
6" Daisy Chain Connector

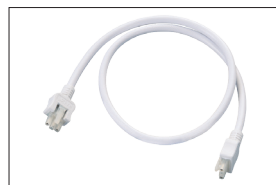

HU1010
12" Daisy Chain Connector

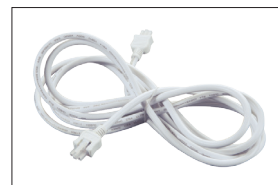

HU1011
18" Daisy Chain Connector

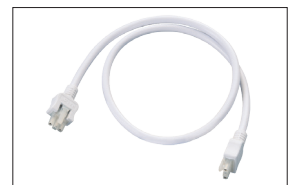

HU103
24" Daisy Chain Connector

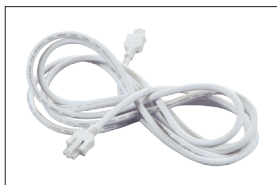

HU104
120" Daisy Chain Connector

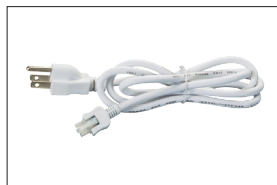

HU105
48" Power Cord - 120V only



HU109
Splice Box



HU107
1-1/2" Male-to-Male Connector

Finish: **P** = White; **MB** = Matte Black Example: HU101P = 3" Daisy Chain Connector, White

PHOTOMETRY

Fixture Application Illustration

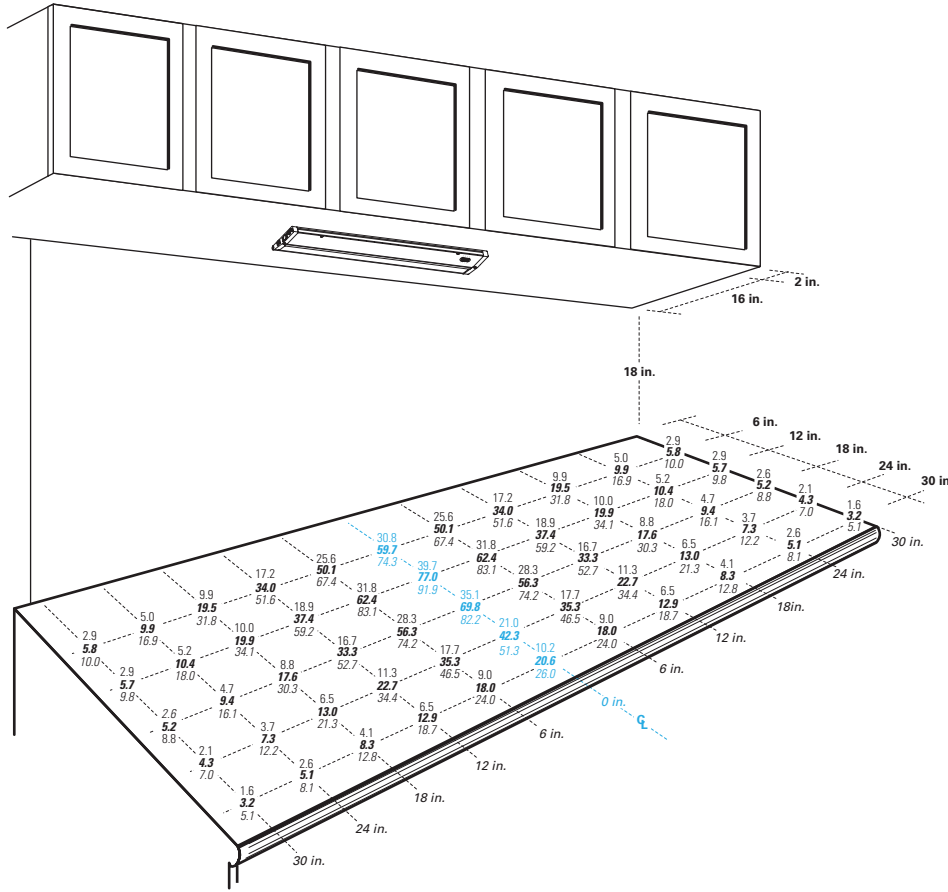

MOUNTING HEIGHT 18"

Top Number Report: HU30SCT09P.IES

Middle Number Report: HU30BSC18P.IES

Bottom Number Report: HU30BSC24P.IES

Countertop 60" x 30"

Diagram not to scale.

18" Mounting Height

Top Number Report - HU30SCT09P

Middle Number Report - HU30BSC18P

Bottom Number Report - HU30BSC24P

Width											Length
30in	24in	18in	12in	6in	0in	6in	12in	18in	24in	30in	
2.9	5.0	9.9	17.2	25.6	30.8	25.6	17.2	9.9	5.0	2.9	6 in
5.8	9.9	19.5	34.0	50.1	59.7	50.1	34.0	19.5	9.9	5.8	
10.0	16.9	31.8	51.6	67.4	74.3	67.4	51.6	31.8	16.9	10.0	
2.9	5.2	10.0	18.9	31.8	39.7	31.8	18.9	10.0	5.2	2.9	12 in
5.7	10.4	19.9	37.4	62.4	77.0	62.4	37.4	19.9	10.4	5.7	
9.8	18.0	34.1	59.2	83.1	91.9	83.1	59.2	34.1	18.0	9.8	
2.6	4.7	8.8	16.7	28.3	35.1	28.3	16.7	8.8	4.7	2.6	18 in
5.2	9.4	17.6	33.3	56.3	69.8	56.3	33.3	17.6	9.4	5.2	
8.8	16.1	30.3	52.7	74.2	82.2	74.2	52.7	30.3	16.1	8.8	
2.1	3.7	6.5	11.3	17.7	21.0	17.7	11.3	6.5	3.7	2.1	24 in
4.3	7.3	13.0	22.7	35.3	42.3	35.3	22.7	13.0	7.3	4.3	
7.0	12.2	21.3	34.4	46.5	51.3	46.5	34.4	21.3	12.2	7.0	
1.6	2.6	4.1	6.5	9.0	10.2	9.0	6.5	4.1	2.6	1.6	30 in
3.2	5.1	8.3	12.9	18.0	20.6	18.0	12.9	8.3	5.1	3.2	
5.1	8.1	12.8	18.7	24.0	26.0	24.0	18.7	12.8	8.1	5.1	

15" Mounting Height

Top Number Report - HU30SCT09P

Middle Number Report - HU30BSC18P

Bottom Number Report - HU30BSC24P

Width											Length
30in	24in	18in	12in	6in	0in	6in	12in	18in	24in	30in	
2.4	4.2	8.9	17.1	28.5	36.4	28.5	17.1	8.9	4.2	2.4	6 in
4.7	8.4	17.8	33.8	56.0	70.4	56.0	33.8	17.8	8.4	4.7	
8.3	14.9	30.5	54.1	75.1	83.3	75.1	54.1	30.5	14.9	8.3	
2.3	4.5	9.3	20.1	40.3	55.3	40.3	20.1	9.3	4.5	2.3	12 in
4.7	8.9	18.5	39.9	79.4	107.4	79.4	39.9	18.5	8.9	4.7	
8.2	16.3	34.5	69.8	107.1	117.5	107.1	69.8	34.5	16.3	8.2	
2.1	4.0	8.1	17.7	35.6	48.3	35.6	17.7	8.1	4.0	2.1	18 in
4.2	7.9	16.3	35.4	71.0	96.5	71.0	35.4	16.3	7.9	4.2	
7.3	14.4	30.5	61.7	94.9	104.5	94.9	61.7	30.5	14.4	7.3	
1.7	3.0	5.7	11.1	19.3	24.3	19.3	11.1	5.7	3.0	1.7	24 in
3.4	6.0	11.5	22.2	38.6	48.9	38.6	22.2	11.5	6.0	3.4	
5.7	10.5	19.9	35.6	50.9	56.5	50.9	35.6	19.9	10.5	5.7	
1.2	2.0	3.4	5.6	8.4	9.7	8.4	5.6	3.4	2.0	1.2	30 in
2.5	4.0	6.8	11.3	16.8	19.7	16.8	11.3	6.8	4.0	2.5	
4.0	6.6	10.9	16.7	22.0	24.1	22.0	16.7	10.9	6.6	4.0	