

DESCRIPTION

Designed for sloped ceiling installations for ceilings from 2/12 to 12/12 pitch. The socket aiming mechanism allows the lamp to be aimed straight down regardless of ceiling pitch. H6451C is sealed and gasketed to limit airflow between plenum and heated or air conditioned areas.

Catalog #	Type
Project	
Comments	
Prepared by	Date

SPECIFICATION FEATURES

A...Reflector/Baffle

Round aperture matches other recessed downlights and provides a clean finished look.

B...Trim Ring

Aluminum Trim Ring

C...Housing

Aluminum single wall housing.

D...Junction Box

Junction Box is UL listed for through branch circuit wiring and has seven 1/2" knockouts with true pry-out slots and four Romex pry-outs slots with integral strain relief.

E...GOT NAIL! Pass-N-Thru™ Bar Hangers

Bar Hanger Features include:

- Pre-installed nail easily installs in regular lumber, engineered lumber and laminated beams
- Safety and guidance system prevents snagging, ensures smooth straight nail penetration and allows bar hangers to be easily removed if necessary.

- Automatic levelling flange aligns the housing and lets you hold the housing in place with one hand while driving nails
- Housing can be positioned at any point within 24" joist span
- Score lines allow "toolless" shortening for 12" joists
- Bar hangers may be repositioned 90°
- Bar hangers do not need to be removed from frame for shortening
- Integral T-bar clips snaps onto T-bars - no additional clips required

F...Socket

Exclusive socket aiming mechanism swivels and rotates to properly align lamp. Lamp socket and trim can be adjusted 20° laterally for compound slope ceiling or to compensate for off axis aiming. Socket plug provides protection against paint overspray.

G...Integral Thermal Protector

Integral thermal protector guards against improper lamping.

Labels

- UL Listed for Damp Location
 - UL listed for Feed Through
 - UL listed for Direct Contact with Insulation and combustible material
 - CSA Certified
- Meets following requirements:
- State of California Title 24
 - Washington State Energy Code
 - International Energy Conservation Code (IECC)
 - New York State Energy Conservation Construction Code
 - Certified Under ASTM-E283

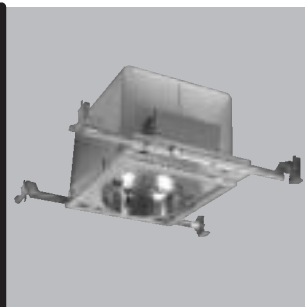

H6451C

**P A R 3 0 L , R 3 0 ,
B R 3 0**

**ALLSLOPE
IC
AIR-TITE HOUSING**

**FOR INSULATED
SLOPED CEILINGS
AND DIRECT
CONTACT WITH
INSULATION**

**AIR-TITE HOUSING
PREVENTS AIRFLOW
BETWEEN ATTIC AND
LIVING AREAS**

airtite™

with all trims listed

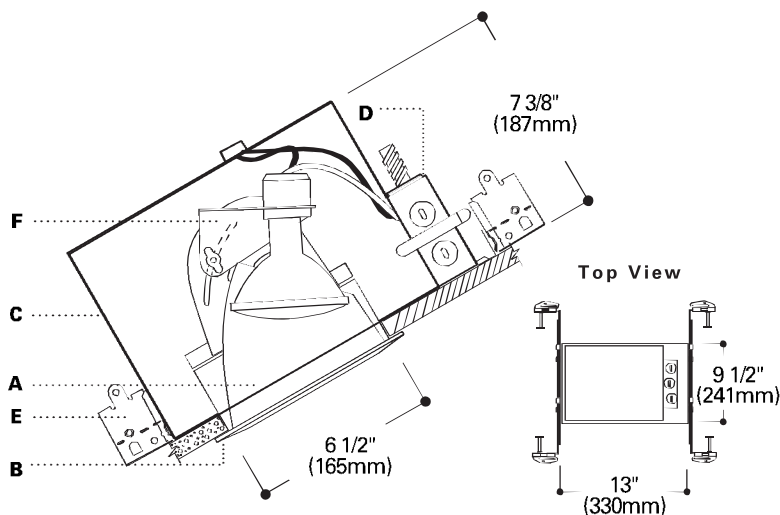







ORDERING INFORMATION SAMPLE NUMBER: H6451C455SC

Complete unit consists of housing and trim.

Housing

H6451C=7" Allslope IC AIR-TITE Housing

Trims

	<p>Specular Reflector 75W PAR30L, 75WR30, 65W BR30 455SC=Specular Clear 455CG=Champagne Gold OD: 7 1/4" (184mm)</p>		<p>Baffle Eyeball - 30° Tilt 75W R30, 65W BR30 417P=Black Baffle, White Eyeball and Ring 417PB=Black Baffle, Brass Eyeball and Ring 417W=White Baffle, White Eyeball and Ring OD: 8" (203mm)</p>
	<p>Black Coilex Baffle 50W PAR30L, 60W BR30 456P=Black Baffle, White Trim Ring OD: 7 1/4" (184mm)</p>		<p>Eyeball - 30° Tilt 65W BR30, 75W R30, 75W PAR30L 78P=White Eyeball and Ring 78B=Brass Eyeball and Ring 78PB=Polished Brass Eyeball and Ring OD: 8" (203mm)</p>
	<p>White Coilex Baffle 50W PAR30L, 65W BR30 75W PAR30L (with H1999 Socket Extender) 456W=White Baffle, White Trim Ring OD: 7 1/4" (184mm)</p>		<p>Albalite Lens 60W A19 170PS=Albalite Lens, White Ring OD: 8" (203mm)</p>
			<p>Eyeball - 30° Tilt 75W PAR30 74P=White Eyeball, White Ring OD: 8" (203mm)</p>

Note: Specifications and Dimensions subject to change without notice.

Visit our web site at www.cooperlighting.com

Customer First Center 1121 Highway 74 South Peachtree City, GA 30269 770.486.4800 FAX 770 486.4801
 Cooper Lighting 5925 McLaughlin Rd. Mississauga, Ontario, Canada L5R 1B8 905.507.4000 FAX 905.568.7049

DESCRIPTION

Designed for sloped ceiling installations for ceilings from 2/12 to 12/12 pitch. The socket aiming mechanism allows the lamp to be aimed straight down regardless of ceiling pitch. H6451C is sealed and gasketed to limit airflow between plenum and heated or air conditioned areas.

Catalog #	Type
Project	
Comments	
Prepared by	Date

SPECIFICATION FEATURES

A...Reflector/Baffle

Round aperture matches other recessed downlights and provides a clean finished look.

B...Trim Ring

Aluminum Trim Ring

C...Housing

Aluminum single wall housing.

D...Junction Box

Junction Box is UL listed for through branch circuit wiring and has seven 1/2" knockouts with true pry-out slots and four Romex pry-outs slots with integral strain relief.

E...GOT NAIL! Pass-N-Thru™ Bar Hangers

Bar Hanger Features include:

- Pre-installed nail easily installs in regular lumber, engineered lumber and laminated beams
- Safety and guidance system prevents snagging, ensures smooth straight nail penetration and allows bar hangers to be easily removed if necessary.

- Automatic levelling flange aligns the housing and lets you hold the housing in place with one hand while driving nails
- Housing can be positioned at any point within 24" joist span
- Score lines allow "toolless" shortening for 12" joists
- Bar hangers may be repositioned 90°
- Bar hangers do not need to be removed from frame for shortening
- Integral T-bar clips snaps onto T-bars - no additional clips required

F...Socket

Exclusive socket aiming mechanism swivels and rotates to properly align lamp. Lamp socket and trim can be adjusted 20° laterally for compound slope ceiling or to compensate for off axis aiming. Socket plug provides protection against paint overspray.

G...Integral Thermal Protector

Integral thermal protector guards against improper lamping.

Labels

- UL Listed for Damp Location
 - UL listed for Feed Through
 - UL listed for Direct Contact with Insulation and combustible material
 - CSA Certified
- Meets following requirements:
- State of California Title 24
 - Washington State Energy Code
 - International Energy Conservation Code (IECC)
 - New York State Energy Conservation Construction Code
 - Certified Under ASTM-E283



H6451C

**P A R 3 0 L , R 3 0 ,
B R 3 0**
**ALLSLOPE
IC
AIR-TITE HOUSING**

**FOR INSULATED
SLOPED CEILING
AND DIRECT
CONTACT WITH
INSULATION**

**AIR-TITE HOUSING
PREVENTS AIRFLOW
BETWEEN ATTIC AND
LIVING AREAS**



with all trims listed

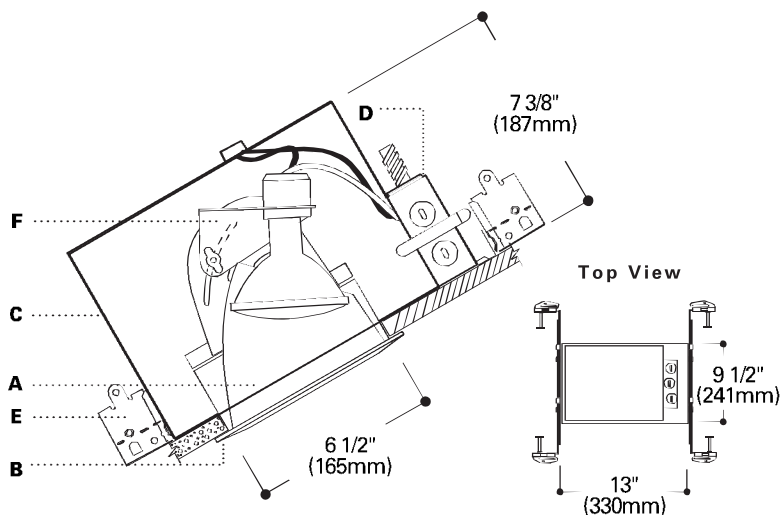

ADV042514





ORDERING INFORMATION SAMPLE NUMBER: H6451C455SC

Complete unit consists of housing and trim.

Housing

H6451C=7" Allslope IC AIR-TITE Housing

Trims

	<p>Specular Reflector 75W PAR30L, 75WR30, 65W BR30 455SC=Specular Clear 455CG=Champagne Gold OD: 7 1/4" (184mm)</p>		<p>Baffle Eyeball - 30° Tilt 75W R30, 65W BR30 417P=Black Baffle, White Eyeball and Ring 417PB=Black Baffle, Brass Eyeball and Ring 417W=White Baffle, White Eyeball and Ring OD: 8 "(203mm)</p>
	<p>Black Coilex Baffle 50W PAR30L, 60W BR30 456P=Black Baffle, White Trim Ring OD: 7 1/4" (184mm)</p>		<p>Eyeball - 30° Tilt 65W BR30, 75W R30, 75W PAR30L 78P=White Eyeball and Ring 78B=Brass Eyeball and Ring 78PB=Polished Brass Eyeball and Ring OD: 8 "(203mm)</p>
	<p>White Coilex Baffle 50W PAR30L, 65W BR30 75W PAR30L (with H1999 Socket Extender) 456W=White Baffle, White Trim Ring OD: 7 1/4" (184mm)</p>		<p>Albalite Lens 60W A19 170PS=Albalite Lens, White Ring OD: 8 "(203mm)</p>
			<p>Eyeball - 30° Tilt 75W PAR30 74P=White Eyeball, White Ring OD: 8 "(203mm)</p>

Note: Specifications and Dimensions subject to change without notice.

Visit our web site at www.cooperlighting.com