

Metalux AP Series

DESCRIPTION

FM series is a versatile LED ceiling or wall mount series which can be used in a broad range of residential and commercial applications. This series provides customers with a high quality luminaire utilizing the latest LED, solid state lighting and electronic driver technology for optimal performance and maximized energy efficiency. With a traditional opal white lens, the FM series produces even, uniform light distribution and ideal choice for offices, corridors, stairways, bedroom, closet and foyers applications where customers are replacing incandescent, circline or compact fluorescent lamps.

Catalog #		Type
Project		
Comments		Date
Prepared by		

SPECIFICATION FEATURES

Construction

Housing consists of die formed steel which is post painted to offer the ideal aesthetics. Diffuser are white opal injection molded acrylic blends offering the ideal light distribution. These lens are offered in three different sizes: 9, 11, 15, 19 inch models. Lens are attached with easy mount tabs.

Controls

Equipped standard with triac dimmable electronic drivers which provides extensive energy savings over existing fluorescent lamp options. All drivers are suitable for 120V applications. Dimmable to 10%; compatible with most Triac dimmers.

Electrical

Long-Life LED system coupled with electrical driver to deliver optimal performance. LEDs are 3000K or 4000K with a typical CRI 80. Projected life is 50,000 hours at 70% lumen output.

Shielding

Specially developed LED lens blend allows this product series to offer optimal light out and providing smooth even illumination with no pixilation. Lenses are designed from smooth opal white acrylic and provide 360° uniform light distribution. Lens is securely held in place by swing clips and can be easily removed for installation and maintenance.

Installation

Fixture may be surface (wall or ceiling) mounted.

Compliance

UL/CUL Listed. Energy Star Qualified. Lighting Facts Approved. Suitable for Damp locations.



FM LED Flushmount

Wall or Ceiling Mount

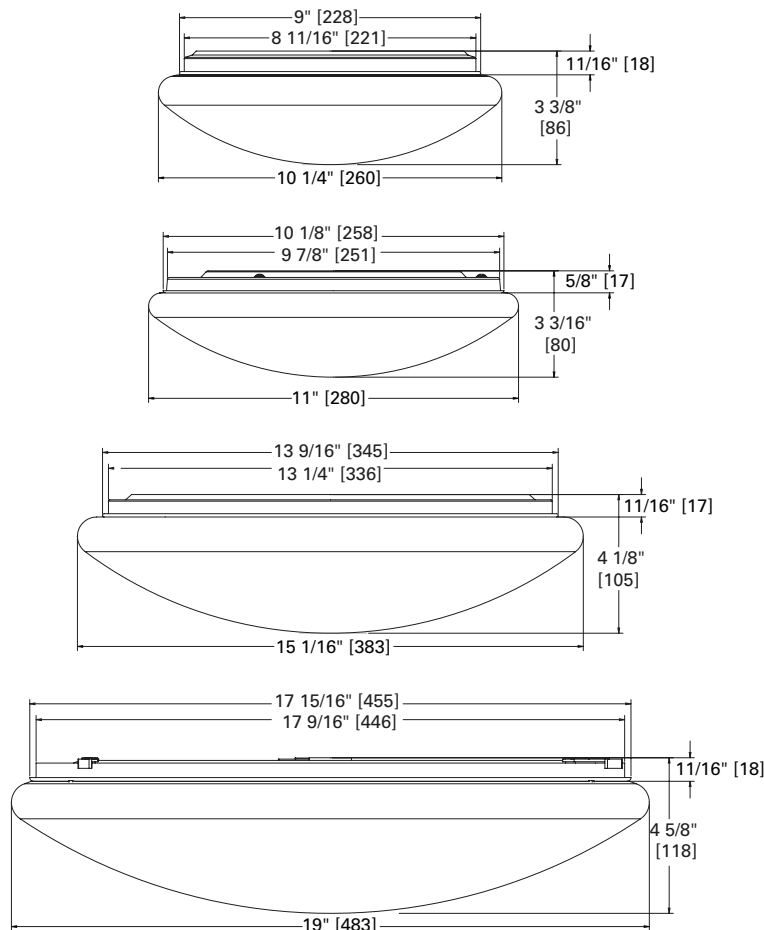

Wattage

Size	3000K	4000K	Watts
9"	950	950	12.2
11"	1050	1100	13.5
15"	1600	1700	21.3
19"	2350	2450	30.5

ORDERING INFORMATION

Application FM	Fixture Size	Color W	Fixture Shape R	CCT	Voltage R
FM = Flush Mount	9 = 9" 11 = 11" 15 = 15" 19 = 19"	W = White	R = Round	30 = 3000K 40 = 4000K	R = 120V

Specifications & dimensions subject to change without notice.
Consult your Eaton Representative for availability and ordering information.

3000K LIGHTING FACTS

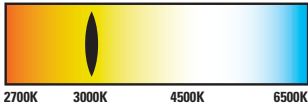
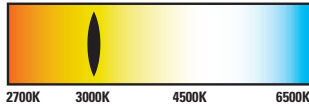
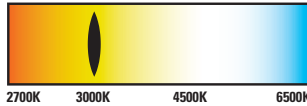
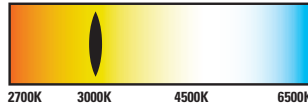
PRODUCT SPECIFICATIONS	PRODUCT SPECIFICATIONS	PRODUCT SPECIFICATIONS	PRODUCT SPECIFICATIONS
Lumens (Light Output) 950	Lumens (Light Output) 1050	Lumens (Light Output) 1600	Lumens (Light Output) 2350
Watts 12.2	Watts 13.5	Watts 21.3	Watts 30.4
Lumens Per Watt (Efficacy) 78	Lumens Per Watt (Efficacy) 78	Lumens Per Watt (Efficacy) 75	Lumens Per Watt (Efficacy) 77
Color Accuracy (CRI) 80	Color Accuracy (CRI) 80	Color Accuracy (CRI) 80	Color Accuracy (CRI) 80
Light Color (CCT) 3000K <small>Correlated Color Temperature (CCT)</small>	Light Color (CCT) 3000K <small>Correlated Color Temperature (CCT)</small>	Light Color (CCT) 3000K <small>Correlated Color Temperature (CCT)</small>	Light Color (CCT) 3000K <small>Correlated Color Temperature (CCT)</small>
			
FM9WR30R	FM11WR30R	FM15WR30R	FM19WR30R

4000K LIGHTING FACTS

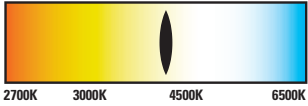
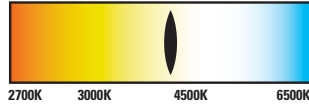
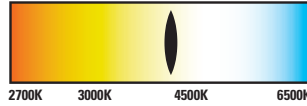
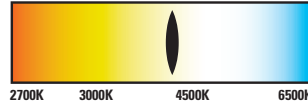
PRODUCT SPECIFICATIONS	PRODUCT SPECIFICATIONS	PRODUCT SPECIFICATIONS	PRODUCT SPECIFICATIONS
Lumens (Light Output) 950	Lumens (Light Output) 1100	Lumens (Light Output) 1700	Lumens (Light Output) 2450
Watts 11.4	Watts 13.3	Watts 20.2	Watts 30.5
Lumens Per Watt (Efficacy) 83	Lumens Per Watt (Efficacy) 83	Lumens Per Watt (Efficacy) 83	Lumens Per Watt (Efficacy) 80
Color Accuracy (CRI) 80	Color Accuracy (CRI) 80	Color Accuracy (CRI) 80	Color Accuracy (CRI) 80
Light Color (CCT) 4000K <small>Correlated Color Temperature (CCT)</small>	Light Color (CCT) 4000K <small>Correlated Color Temperature (CCT)</small>	Light Color (CCT) 4000K <small>Correlated Color Temperature (CCT)</small>	Light Color (CCT) 4000K <small>Correlated Color Temperature (CCT)</small>
			
FM9WR40R	FM11WR40R	FM15WR40R	FM19WR40R

Shipping Data

Catalog No.	Individual Wt.	Master Pack
FM9	1.0 lbs.	8
FM11	1.8 lbs.	4
FM15	3.5 lbs.	4
FM19	5.6 lbs.	2

Retail Catalog Data

Catalog No.	UPC	I2of5
FM9WR30R	080083757510	10080083757517
FM9WR40R	080083770168	10080083757494
FM11WR30R	080083757473	10080083757470
FM11WR40R	080083770083	10080083770080
FM15WR30R	080083757435	10080083757432
FM15WR40R	080083760466	10080083760463
FM19WR30R	080083757398	10080083757395
FM19WR40R	080083760473	10080083760470

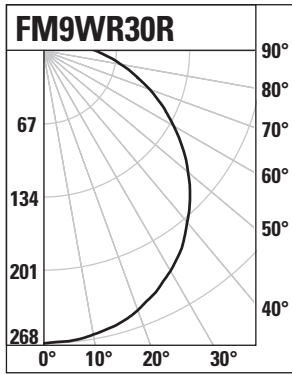

Description
9" Circular LED flush mount luminaire

CCT = 3000K
Lumens = 1048.1
Input Watts = 12.2
Efficacy = 85.9
Test Report = P27993

Zonal Lumen Summary		
Zone	Lumens	% Fixture
0°-30°	211.1	20.1
0°-40°	348.9	33.3
0°-60°	635.1	60.6
0°-90°	912.1	87
0°-180°	1048.1	100

Coefficients of Utilization

rc	rw	Effective floor cavity reflectance 20%																							
		80%				70%				50%				30%				10%				0			
		70	50	30	10	70	50	30	10	50	30	10	50	60	10	50	30	10	50	30	10				
RCR																									
0	116	116	116	116	112	112	112	112	104	104	104	97	97	97	90	90	90	87							
1	104	98	93	88	99	94	90	85	88	84	80	81	78	76	76	73	71	68							
2	93	84	77	70	89	81	74	68	75	70	65	70	65	61	65	61	58	55							
3	85	73	64	57	81	71	63	56	66	59	53	61	56	51	57	52	48	45							
4	77	64	55	48	74	62	54	47	58	51	45	54	48	43	51	45	41	38							
5	71	57	48	41	68	55	47	40	52	44	39	48	42	37	45	40	35	33							
6	65	51	42	36	62	50	41	35	47	39	34	44	37	32	41	35	31	29							
7	60	46	37	31	58	46	37	31	42	35	30	42	35	30	37	32	27	25							
8	56	42	34	28	54	41	33	27	39	31	26	36	30	25	34	29	24	22							
9	52	39	30	25	50	38	30	24	35	28	24	33	27	23	32	26	22	20							
10	49	36	28	22	47	35	27	22	33	26	21	31	25	21	29	24	20	18							

Candlepower		
0°	Flux	
0°	268	
5°	267	25
15°	260	73
25°	244	112
35°	221	138
45°	190	147
55°	156	140
65°	121	120
75°	87	92
85°	59	51
90°	48	26

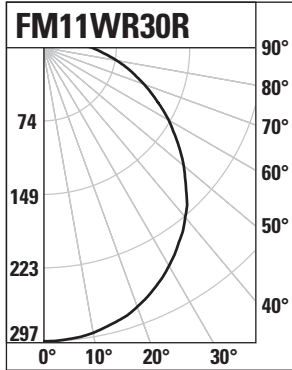

Description
11" Circular LED flush mount luminaire

CCT = 3000K
Lumens = 1098.5
Input Watts = 13.5
Efficacy = 81.4
Test Report = P27995

Zonal Lumen Summary		
Zone	Lumens	% Fixture
0°-30°	232.9	21.2
0°-40°	383.3	34.9
0°-60°	690.6	62.9
0°-90°	981.4	89.3
0°-180°	1098.5	100

Coefficients of Utilization

rc	rw	Effective floor cavity reflectance 20%																							
		80%				70%				50%				30%				10%				0			
		70	50	30	10	70	50	30	10	50	30	10	50	60	10	50	30	10	50	30	10				
RCR																									
0	117	117	117	117	113	113	113	113	105	105	105	98	98	98	92	92	92	89							
1	104	98	93	89	100	95	90	86	89	85	82	83	80	77	78	75	73	70							
2	94	85	77	71	90	82	75	69	77	71	66	72	67	63	67	63	60	57							
3	85	74	65	58	82	71	63	57	67	60	54	63	57	52	59	54	50	47							
4	78	65	56	49	75	63	54	48	59	52	46	55	49	44	52	47	42	40							
5	71	58	49	42	68	56	47	41	53	45	39	50	43	38	47	41	37	34							
6	66	52	43	36	63	50	42	36	48	40	34	45	38	33	42	37	32	30							
7	61	47	38	32	59	46	37	31	43	36	30	41	34	29	39	33	28	26							
8	57	43	34	28	54	42	33	28	39	32	27	37	31	26	35	30	25	23							
9	53	39	31	25	51	38	30	25	36	29	24	34	28	24	33	27	23	21							
10	50	36	28	23	48	35	28	22	34	27	22	32	26	21	30	25	21	19							

Candlepower		
0°	Flux	
0°	297	
5°	296	28
15°	287	81
25°	268	124
35°	240	150
45°	205	159
55°	166	149
65°	127	126
75°	92	97
85°	61	53
90°	49	27

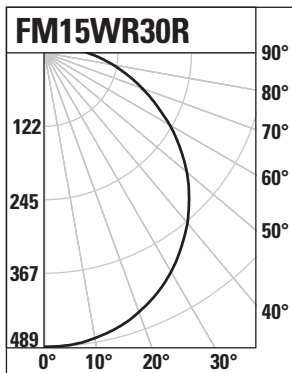

Description
15" Circular LED flush mount luminaire

CCT = 3000K
Lumens = 1793.9
Input Watts = 21.4
Efficacy = 83.8
Test Report = P27997

Zonal Lumen Summary		
Zone	Lumens	% Fixture
0°-30°	383.6	21.4
0°-40°	631.7	35.2
0°-60°	1140.4	63.6
0°-90°	1596.7	89
0°-180°	1793.9	100

Coefficients of Utilization

rc	rw	Effective floor cavity reflectance 20%																							
		80%				70%				50%				30%				10%				0			
		70	50	30	10	70	50	30	10	50	30	10	50	60	10	50	30	10	50	30	10				
RCR																									
0	116	116	116	116	112	112	112	112	105	105	105	98	98	98	92	92	92	89							
1	104	99	94	89	100	95	91	87	89	85	82	83	80	78	78	76	73	70							
2	94	85	78	71	90	82	75	70	77	71	66	72	67	63	67	64	60	57							
3	85	74	66	59	82	72	64	57	67	60	55	63	57	53	59	54	50	48							
4	78	65	56	49	75	63	55	48	59	52	46	56	50	45	52	47	43	40							
5	72	58	49	42	69	56	48	41	53	46	40	50	43	38	47	41	37	35							
6	66	52	43	37	63	51	42	36	48	40	35	45	39	34	43	37	32	30							
7	61	47	38	32	59	46	38	32	43	36	31	41	34	30	39	33	29	26							
8	57	43	34	28	55	42	34	28	40	32	27	38	31	26	36	30	26	24							
9	53	39	31	25	51	38	31	25	36	29	24	35	28	24	33	27	23	21							
10	50	36	28	23	48	35	28	23	34	27	22	32	26	21	30	25	21	19							

Candlepower		
0°	Flux	
0°	489	
5°	488	46
15°	473	134
25°	442	204
35°	396	248
45°	340	263
55°	275	246
65°	205	204
75°	143	152
85°	92	80
90°	71	39

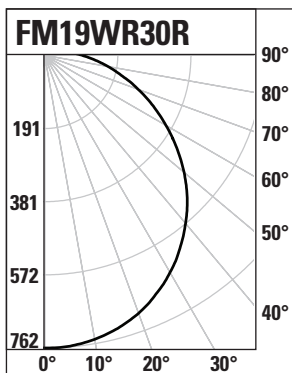

Description
19" Circular LED flush mount luminaire

CCT = 3000K
Lumens = 2669.6
Input Watts = 30.5
Efficacy = 87.5
Test Report = P27999

Zonal Lumen Summary		
Zone	Lumens	% Fixture
0°-30°	596.6	22.3
0°-40°	981	36.7
0°-60°	1761.6	66
0°-90°	2437.8	91.3
0°-180°	2669.6	100

Coefficients of Utilization

rc	rw	Effective floor cavity reflectance 20%																							
		80%				70%				50%				30%				10%				0			
		70	50	30	10	70	50	30	10	50	30	10	50	60	10	50	30	10	50	30	10				
RCR																									
0	117	117	117	117	113	113	113	113	106	106	106	100	100	100	94	94	94	91							
1	105	99	95	90	101	96	92	88	90	87	83	85	82	79	80	78	75	73							
2	95	86	78	72	91	83	76	71	78	73	68	74	69	65	69	65	62	59							
3	86	75	66	59	83	73	65	58	68	62	56	64	59	54	61	56	52	49							
4	79	66	57	50	76	64	56	49	61	53	47	57	51	46	54	49	44	42							
5	72	59	50	43	69	57	49	42	54	47	41	51	45	40	48	43	38	36							
6	67	53	44	37	64	51	43	37	49	41	36	46	40	35	44	38	34	31							
7	62	48	39	33	59	47	38	32	44	37	31	42	35	31	40	34	30	28							
8	57	44	35	29	55	43	34	29	40	33	28	39	32	27	37	31	27	25							
9	54	40	32	26	52	39	31	26	37	30	25	35	29	24	34	28	24	22							
10	50	37	29	23	48	36	28	23	34	27	23	33	27	22	31	26	22	20							

Candlepower		
0°	Flux	
0°	762	
5°	760	72
15°	736	208
25°		

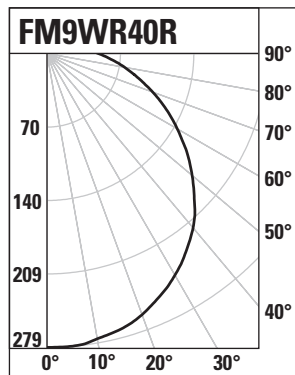

Description
9" Circular LED flush mount luminaire

CCT = 4000K
Lumens = 1090
Input Watts = 11.4
Efficacy = 95.6
Test Report = P27994

Zonal Lumen Summary		
Zone	Lumens	% Fixture
0°-30°	220.2	20.2
0°-40°	364.3	33.4
0°-60°	662.1	60.7
0°-90°	948.4	87
0°-180°	1090	100

Coefficients of Utilization

rc rw	Effective floor cavity reflectance 20%																	
	80%				70%				50%			30%			10%		0	
	70	50	30	10	70	50	30	10	50	30	10	50	60	10	50	30	10	0
RCR																		
0	116	116	116	116	112	112	112	112	104	104	104	97	97	97	90	90	90	87
1	104	98	93	88	99	94	90	86	88	84	80	81	78	76	76	73	71	68
2	93	84	77	70	89	81	74	68	75	70	65	70	65	61	65	61	58	55
3	85	73	65	58	81	71	63	56	66	59	53	61	56	51	57	52	48	46
4	77	65	55	48	74	62	54	47	58	51	45	54	48	43	51	45	41	38
5	71	57	48	41	68	56	47	40	52	44	39	49	42	37	45	40	35	33
6	65	52	42	36	62	50	41	35	47	39	34	44	37	32	41	35	31	29
7	60	47	38	31	58	45	37	31	42	35	30	40	33	28	37	32	27	25
8	56	42	34	28	54	41	33	27	39	31	26	36	30	25	34	29	24	22
9	52	39	30	25	50	38	30	24	36	29	24	34	27	23	32	26	22	20
10	49	36	28	22	47	35	27	22	33	26	21	31	25	21	29	24	20	18

Candlepower		
0°	Flux	
0°	279	
5°	279	27
15°	271	76
25°	254	117
35°	230	144
45°	198	153
55°	162	145
65°	125	124
75°	90	95
85°	61	53
90°	49	27

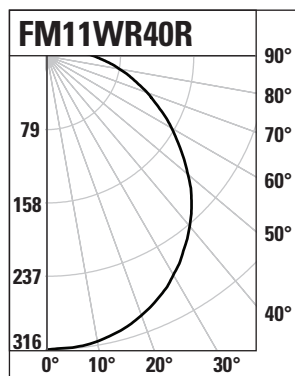

Description
11" Circular LED flush mount luminaire

CCT = 4000K
Lumens = 1162.7
Input Watts = 13.3
Efficacy = 87.4
Test Report = P27996

Zonal Lumen Summary		
Zone	Lumens	% Fixture
0°-30°	248.2	21.3
0°-40°	408.7	35.2
0°-60°	736	63.3
0°-90°	1041.5	89.6
0°-180°	1162.7	100

Coefficients of Utilization

rc rw	Effective floor cavity reflectance 20%																	
	80%				70%				50%			30%			10%		0	
	70	50	30	10	70	50	30	10	50	30	10	50	60	10	50	30	10	0
RCR																		
0	117	117	117	117	113	113	113	113	105	105	105	99	99	99	92	92	92	90
1	104	99	94	89	100	95	91	87	89	85	82	83	80	77	78	76	73	70
2	94	85	77	71	90	82	75	69	77	71	66	72	67	63	67	63	60	57
3	85	74	65	58	82	72	64	57	67	60	55	63	57	52	59	54	50	47
4	78	65	56	49	75	63	54	48	59	52	46	56	49	44	52	47	43	40
5	71	58	49	42	69	56	48	41	53	45	40	50	43	38	47	41	37	34
6	66	52	43	36	63	51	42	36	48	40	35	45	38	33	43	37	32	30
7	61	47	38	32	59	46	37	31	43	36	30	41	34	30	39	33	29	26
8	57	43	34	28	55	42	34	28	40	32	27	38	31	26	36	30	26	23
9	53	39	31	25	51	38	30	25	36	29	24	35	28	24	33	27	23	21
10	50	36	28	23	48	35	28	23	34	27	22	32	26	21	30	25	21	19

Candlepower		
0°	Flux	
0°	316	
5°	315	30
15°	306	86
25°	286	132
35°	256	160
45°	220	170
55°	176	158
65°	134	133
75°	96	102
85°	64	56
90°	51	28

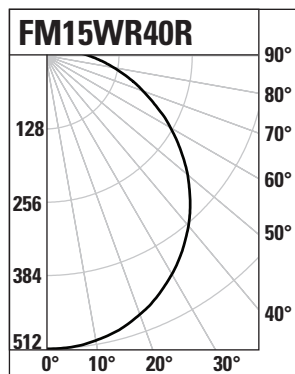

Description
15" Circular LED flush mount luminaire

CCT = 4000K
Lumens = 1880.8
Input Watts = 20.3
Efficacy = 92.7
Test Report = P27998

Zonal Lumen Summary		
Zone	Lumens	% Fixture
0°-30°	401.9	21.4
0°-40°	662.2	35.2
0°-60°	1195.4	63.6
0°-90°	1673.9	89
0°-180°	1880.8	100

Coefficients of Utilization

rc rw	Effective floor cavity reflectance 20%																	
	80%				70%				50%			30%			10%		0	
	70	50	30	10	70	50	30	10	50	30	10	50	60	10	50	30	10	0
RCR																		
0	116	116	116	116	112	112	112	112	105	105	105	98	98	98	92	92	92	89
1	104	99	94	89	100	95	91	87	89	85	82	83	80	78	78	76	73	70
2	94	85	78	71	90	82	75	70	77	71	66	72	67	63	67	64	60	57
3	85	74	66	59	82	72	64	57	67	60	55	63	57	53	59	54	50	48
4	78	65	56	49	75	63	54	48	59	52	46	56	50	45	52	47	43	40
5	72	58	49	42	69	56	48	41	53	46	40	50	43	38	47	41	37	35
6	66	52	43	37	63	51	42	36	48	40	35	45	39	34	43	37	32	30
7	61	47	38	32	59	46	38	32	43	36	31	41	34	30	39	33	29	26
8	57	43	34	28	55	42	34	28	40	32	27	38	31	26	36	30	26	24
9	53	39	31	25	51	38	31	25	36	29	24	35	28	24	33	27	23	21
10	50	36	28	23	48	35	28	23	34	27	22	32	26	21	30	25	21	19

Candlepower		
0°	Flux	
0°	512	
5°	511	49
15°	496	140
25°	463	213
35°	416	260
45°	357	275
55°	288	258
65°	215	214
75°	150	159
85°	96	84
90°	75	41

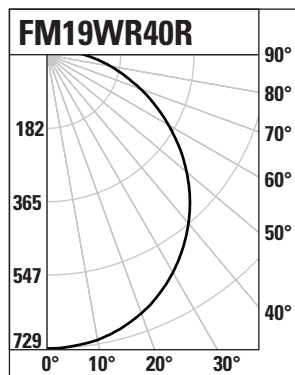

Description
19" Circular LED flush mount luminaire

CCT = 4000K
Lumens = 2552.5
Input Watts = 30.6
Efficacy = 83.4
Test Report = P28000

Zonal Lumen Summary		
Zone	Lumens	% Fixture
0°-30°	570.3	22.3
0°-40°	937.7	36.7
0°-60°	1682.5	65.9
0°-90°	2325.3	91.1
0°-180°	2552.5	100

Coefficients of Utilization

rc rw	Effective floor cavity reflectance 20%																	
	80%				70%				50%			30%			10%		0	
	70	50	30	10	70	50	30	10	50	30	10	50	60	10	50	30	10	0
RCR																		
0	117	117	117	117	113	113	113	113	106	106	106	100	100	100	94	94	94	91
1	105	99	95	90	101	96	92	88	90	87	83	85	82	79	80	77	75	73
2	95	86	78	72	91	83	76	71	78	72	68	73	69	65	69	65	62	59
3	86	75	66	59	83	73	65	58	68	62	56	64	59	54	61	56	52	49
4	79	66	57	50	76	64	56	49	61	53	47	57	51	46	54	49	44	42
5	72	59	50	43	69	57	49	42	54	47	41	51	45	40	48	43	38	36
6	67	53	44	37	64	51	43	37	49	41	36	46	40	35	44	38	34	31
7	62	48	39	33	59	47	38	32	44	37	31	42	35	31	40	34	30	28
8	57	44	35	29	55	43	34	29	40	33	28	39	32	27	37	31	27	24
9	54	40	32	26	52	39	31	26	37	30	25	35	29	24	34	28	24	22
10	50	37	29	23	48	36	28	23	34	27	23	33	27	22	31	26	22	20

Candlepower		
0°	Flux	
0°	729	
5°	726	69
15°	704	199
25°	656	303
35°	587	367
45°	501	386
55°	401	358
65°	296	294
75°	200	212
85°	124	109
90°	94	52

Metalux AP Series

DESCRIPTION

FM series is a versatile LED ceiling or wall mount series which can be used in a broad range of residential and commercial applications. This series provides customers with a high quality luminaire utilizing the latest LED, solid state lighting and electronic driver technology for optimal performance and maximized energy efficiency. With a traditional opal white lens, the FM series produces even, uniform light distribution and ideal choice for offices, corridors, stairways, bedroom, closet and foyers applications where customers are replacing incandescent, circline or compact fluorescent lamps.

Catalog #		Type
Project		
Comments		Date
Prepared by		

SPECIFICATION FEATURES

Construction

Housing consists of die formed steel which is post painted to offer the ideal aesthetics. Diffuser are white opal injection molded acrylic blends offering the ideal light distribution. These lens are offered in three different sizes: 9, 11, 15, 19 inch models. Lens are attached with easy mount tabs.

Controls

Equipped standard with triac dimmable electronic drivers which provides extensive energy savings over existing fluorescent lamp options. All drivers are suitable for 120V applications. Dimmable to 10%; compatible with most Triac dimmers.

Electrical

Long-Life LED system coupled with electrical driver to deliver optimal performance. LEDs are 3000K or 4000K with a typical CRI 80. Projected life is 50,000 hours at 70% lumen output.

Shielding

Specially developed LED lens blend allows this product series to offer optimal light out and providing smooth even illumination with no pixilation. Lenses are designed from smooth opal white acrylic and provide 360° uniform light distribution. Lens is securely held in place by swing clips and can be easily removed for installation and maintenance.

Installation

Fixture may be surface (wall or ceiling) mounted.

Compliance

UL/CUL Listed. Energy Star Qualified. Lighting Facts Approved. Suitable for Damp locations.



FM LED Flushmount

Wall or Ceiling Mount

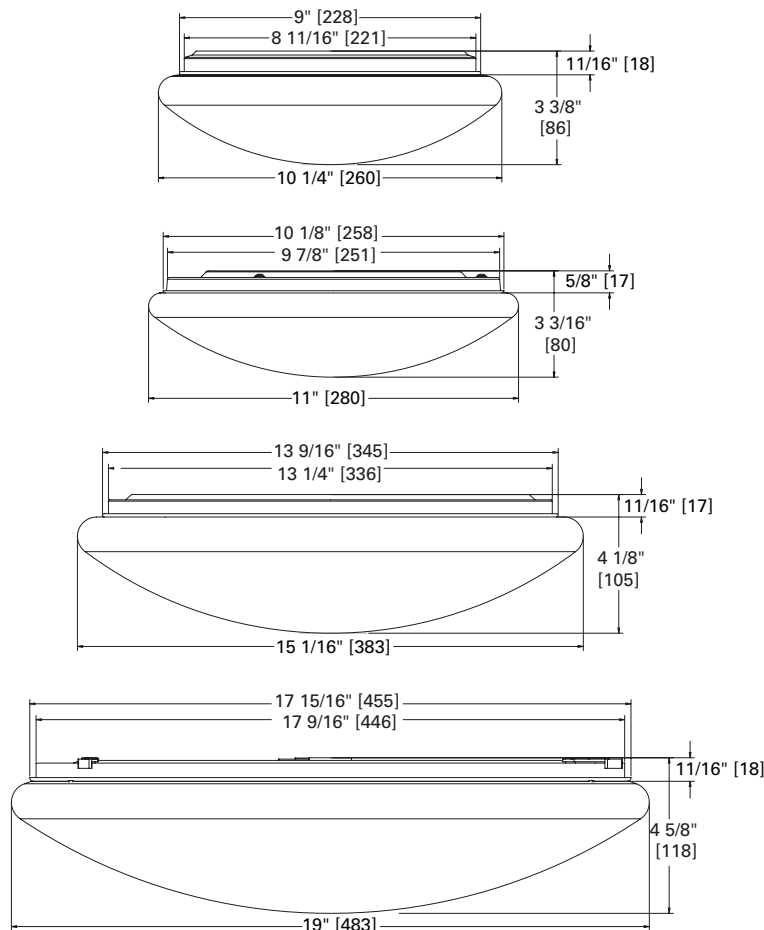

Wattage

Size	3000K	4000K	Watts
9"	950	950	12.2
11"	1050	1100	13.5
15"	1600	1700	21.3
19"	2350	2450	30.5

ORDERING INFORMATION

Application FM	Fixture Size	Color W	Fixture Shape R	CCT	Voltage R
FM = Flush Mount	9 = 9" 11 = 11" 15 = 15" 19 = 19"	W = White	R = Round	30 = 3000K 40 = 4000K	R = 120V

Specifications & dimensions subject to change without notice.
Consult your Eaton Representative for availability and ordering information.

3000K LIGHTING FACTS

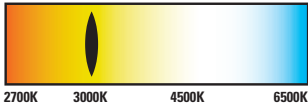
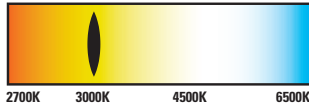
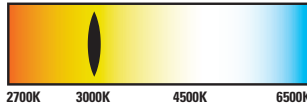
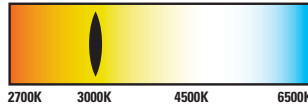
PRODUCT SPECIFICATIONS	PRODUCT SPECIFICATIONS	PRODUCT SPECIFICATIONS	PRODUCT SPECIFICATIONS
Lumens (Light Output) 950	Lumens (Light Output) 1050	Lumens (Light Output) 1600	Lumens (Light Output) 2350
Watts 12.2	Watts 13.5	Watts 21.3	Watts 30.4
Lumens Per Watt (Efficacy) 78	Lumens Per Watt (Efficacy) 78	Lumens Per Watt (Efficacy) 75	Lumens Per Watt (Efficacy) 77
Color Accuracy (CRI) 80	Color Accuracy (CRI) 80	Color Accuracy (CRI) 80	Color Accuracy (CRI) 80
Light Color (CCT) 3000K <small>Correlated Color Temperature (CCT)</small>	Light Color (CCT) 3000K <small>Correlated Color Temperature (CCT)</small>	Light Color (CCT) 3000K <small>Correlated Color Temperature (CCT)</small>	Light Color (CCT) 3000K <small>Correlated Color Temperature (CCT)</small>
			
FM9WR30R	FM11WR30R	FM15WR30R	FM19WR30R

4000K LIGHTING FACTS

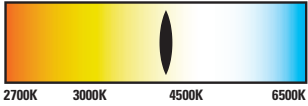
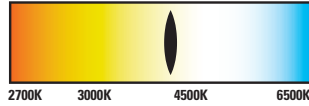
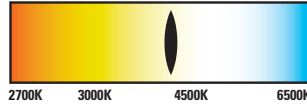
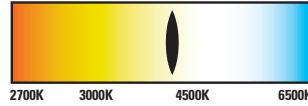
PRODUCT SPECIFICATIONS	PRODUCT SPECIFICATIONS	PRODUCT SPECIFICATIONS	PRODUCT SPECIFICATIONS
Lumens (Light Output) 950	Lumens (Light Output) 1100	Lumens (Light Output) 1700	Lumens (Light Output) 2450
Watts 11.4	Watts 13.3	Watts 20.2	Watts 30.5
Lumens Per Watt (Efficacy) 83	Lumens Per Watt (Efficacy) 83	Lumens Per Watt (Efficacy) 83	Lumens Per Watt (Efficacy) 80
Color Accuracy (CRI) 80	Color Accuracy (CRI) 80	Color Accuracy (CRI) 80	Color Accuracy (CRI) 80
Light Color (CCT) 4000K <small>Correlated Color Temperature (CCT)</small>	Light Color (CCT) 4000K <small>Correlated Color Temperature (CCT)</small>	Light Color (CCT) 4000K <small>Correlated Color Temperature (CCT)</small>	Light Color (CCT) 4000K <small>Correlated Color Temperature (CCT)</small>
			
FM9WR40R	FM11WR40R	FM15WR40R	FM19WR40R

Shipping Data

Catalog No.	Individual Wt.	Master Pack
FM9	1.0 lbs.	8
FM11	1.8 lbs.	4
FM15	3.5 lbs.	4
FM19	5.6 lbs.	2

Retail Catalog Data

Catalog No.	UPC	I2of5
FM9WR30R	080083757510	10080083757517
FM9WR40R	080083770168	10080083757494
FM11WR30R	080083757473	10080083757470
FM11WR40R	080083770083	10080083770080
FM15WR30R	080083757435	10080083757432
FM15WR40R	080083760466	10080083760463
FM19WR30R	080083757398	10080083757395
FM19WR40R	080083760473	10080083760470

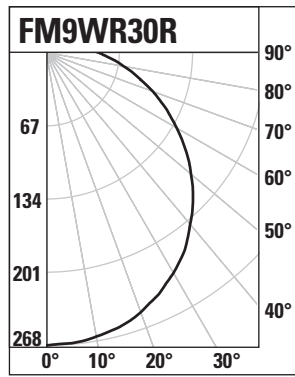

Description
9" Circular LED flush mount luminaire

CCT = 3000K
Lumens = 1048.1
Input Watts = 12.2
Efficacy = 85.9
Test Report = P27993

Zonal Lumen Summary		
Zone	Lumens	% Fixture
0°-30°	211.1	20.1
0°-40°	348.9	33.3
0°-60°	635.1	60.6
0°-90°	912.1	87
0°-180°	1048.1	100

Coefficients of Utilization

rc	rw	Effective floor cavity reflectance 20%																						
		80%				70%				50%		30%		10%		0								
		70	50	30	10	70	50	30	10	50	30	10	50	60	10	50	30	10	0					
RCR																								
0		116	116	116	116	112	112	112	112	104	104	104	97	97	97	90	90	90	87					
1		104	98	93	88	99	94	90	85	88	84	80	81	78	76	76	73	71	68					
2		93	84	77	70	89	81	74	68	75	70	65	70	65	61	65	61	58	55					
3		85	73	64	57	81	71	63	56	66	59	53	61	56	51	57	52	48	45					
4		77	64	55	48	74	62	54	47	58	51	45	54	48	43	51	45	41	38					
5		71	57	48	41	68	55	47	40	52	44	39	48	42	37	45	40	35	33					
6		65	51	42	36	62	50	41	35	47	39	34	44	37	32	41	35	31	29					
7		60	46	37	31	58	46	37	31	42	35	30	40	33	28	37	32	27	25					
8		56	42	34	28	54	41	33	27	39	31	26	36	30	25	34	29	24	22					
9		52	39	30	25	50	38	30	24	35	28	24	33	27	23	32	26	22	20					
10		49	36	28	22	47	35	27	22	33	26	21	31	25	21	29	24	20	18					

Candlepower		
0°	Flux	
0°	268	
5°	267	25
15°	260	73
25°	244	112
35°	221	138
45°	190	147
55°	156	140
65°	121	120
75°	87	92
85°	59	51
90°	48	26

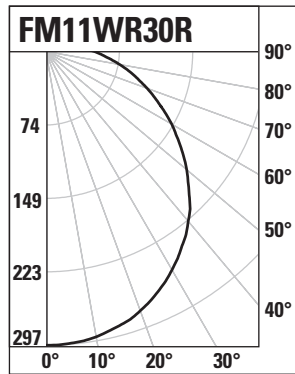

Description
11" Circular LED flush mount luminaire

CCT = 3000K
Lumens = 1098.5
Input Watts = 13.5
Efficacy = 81.4
Test Report = P27995

Zonal Lumen Summary		
Zone	Lumens	% Fixture
0°-30°	232.9	21.2
0°-40°	383.3	34.9
0°-60°	690.6	62.9
0°-90°	981.4	89.3
0°-180°	1098.5	100

Coefficients of Utilization

rc	rw	Effective floor cavity reflectance 20%																					
		80%				70%				50%		30%		10%		0							
		70	50	30	10	70	50	30	10	50	30	10	50	60	10	50	30	10	0				
RCR																							
0		117	117	117	117	113	113	113	113	105	105	105	98	98	98	92	92	92	89				
1		104	98	93	89	100	95	90	86	89	85	82	83	80	77	78	75	73	70				
2		94	85	77	71	90	82	75	69	77	71	66	72	67	63	67	63	60	57				
3		85	74	65	58	82	71	63	57	67	60	54	63	57	52	59	54	50	47				
4		78	65	56	49	75	63	54	48	59	52	46	55	49	44	52	47	42	40				
5		71	58	49	42	68	56	47	41	53	45	39	50	43	38	47	41	37	34				
6		66	52	43	36	63	50	42	36	48	40	34	45	38	33	42	37	32	30				
7		61	47	38	32	59	46	37	31	43	36	30	41	34	29	39	33	28	26				
8		57	43	34	28	54	42	33	28	39	32	27	37	31	26	35	30	25	23				
9		53	39	31	25	51	38	30	25	36	29	24	34	28	24	33	27	23	21				
10		50	36	28	23	48	35	28	22	34	27	22	32	26	21	30	25	21	19				

Candlepower		
0°	Flux	
0°	297	
5°	296	28
15°	287	81
25°	268	124
35°	240	150
45°	205	159
55°	166	149
65°	127	126
75°	92	97
85°	61	53
90°	49	27

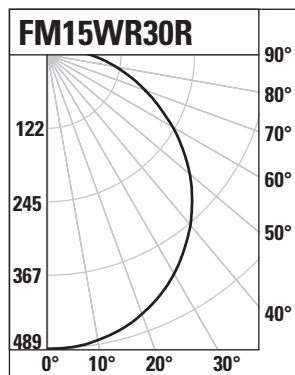

Description
15" Circular LED flush mount luminaire

CCT = 3000K
Lumens = 1793.9
Input Watts = 21.4
Efficacy = 83.8
Test Report = P27997

Zonal Lumen Summary		
Zone	Lumens	% Fixture
0°-30°	383.6	21.4
0°-40°	631.7	35.2
0°-60°	1140.4	63.6
0°-90°	1596.7	89
0°-180°	1793.9	100

Coefficients of Utilization

rc	rw	Effective floor cavity reflectance 20%																					
		80%				70%				50%		30%		10%		0							
		70	50	30	10	70	50	30	10	50	30	10	50	60	10	50	30	10	0				
RCR																							
0		116	116	116	116	112	112	112	112	105	105	105	98	98	98	92	92	92	89				
1		104	99	94	89	100	95	91	87	89	85	82	83	80	78	78	76	73	70				
2		94	85	78	71	90	82	75	70	77	71	66	72	67	63	67	64	60	57				
3		85	74	66	59	82	72	64	57	67	60	55	63	57	53	59	54	50	48				
4		78	65	56	49	75	63	55	48	59	52	46	56	50	45	52	47	43	40				
5		72	58	49	42	69	56	48	41	53	46	40	50	43	38	47	41	37	35				
6		66	52	43	37	63	51	42	36	48	40	35	45	39	34	43	37	32	30				
7		61	47	38	32	59	46	38	32	43	36	31	41	34	30	39	33	29	26				
8		57	43	34	28	55	42	34	28	40	32	27	38	31	26	36	30	26	24				
9		53	39	31	25	51	38	31	25	36	29	24	35	28	24	33	27	23	21				
10		50	36	28	23	48	35	28	23	34	27	22	32	26	21	30	25	21	19				

Candlepower		
0°	Flux	
0°	489	
5°	488	46
15°	473	134
25°	442	204
35°	396	248
45°	340	263
55°	275	246
65°	205	204
75°	143	152
85°	92	80
90°	71	39

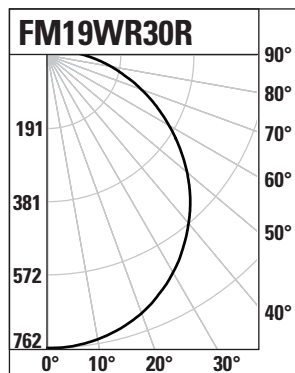

Description
19" Circular LED flush mount luminaire

CCT = 3000K
Lumens = 2669.6
Input Watts = 30.5
Efficacy = 87.5
Test Report = P27999

Zonal Lumen Summary		
Zone	Lumens	% Fixture
0°-30°	596.6	22.3
0°-40°	981	36.7
0°-60°	1761.6	66
0°-90°	2437.8	91.3
0°-180°	2669.6	100

Coefficients of Utilization

rc	rw	Effective floor cavity reflectance 20%																					
		80%				70%				50%		30%		10%		0							
		70	50	30	10	70	50	30	10	50	30	10	50	60	10	50	30	10	0				
RCR																							
0		117	117	117	117	113	113	113	113	106	106	106	100	100	100	94	94	94	91				
1		105	99	95	90	101	96	92	88	90	87	83	85	82	79	80	78	75	73				
2		95	86	78	72	91	83	76	71	78	73	68	74	69	65	69	65	62	59				
3		86	75	66	59	83	73	65	58	68	62	56	64	59	54	61	56	52	49				
4		79	66	57	50	76	64	56	49	61	53	47	57	51	46	54	49	44	42				
5		72	59	50	43	69	57	49	42	54	47	41	51	45	40	48	43	38	36				
6		67	53	44	37	64	51	43	37	49	41	36	46	40	35	44	38	34	31				
7		62	48	39	33	59	47	38	32	44	37	31	42	35	31	40	34	30	28				
8		57	44	35	29	55	43	34	29	40	33	28	39	32	27	37	31	27	25				
9		54	40	32	26	52	39	31	26	37	30	25	35	29	24	34	28	24	22				
10		50	37	29	23	48	36	28	23	34	27	23	33	27	22	31	26	22	20				

Candlepower		
0°	Flux	
0°	762	
5°	760	72
15°	736	208
25°	686	317
35°	614	384

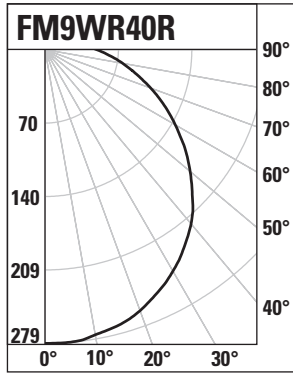

Description
9" Circular LED flush mount luminaire

CCT = 4000K
Lumens = 1090
Input Watts = 11.4
Efficacy = 95.6
Test Report = P27994

Zonal Lumen Summary		
Zone	Lumens	% Fixture
0°-30°	220.2	20.2
0°-40°	364.3	33.4
0°-60°	662.1	60.7
0°-90°	948.4	87
0°-180°	1090	100

Coefficients of Utilization

rc	rw	Effective floor cavity reflectance 20%																	
		80%				70%				50%		30%		10%		0			
		70	50	30	10	70	50	30	10	50	30	10	50	60	10	50	30	10	0
RCR																			
0	116	116	116	116	112	112	112	112	104	104	104	97	97	97	90	90	90	87	
1	104	98	93	88	99	94	90	86	88	84	80	81	78	76	76	73	71	68	
2	93	84	77	70	89	81	74	68	75	70	65	70	65	61	65	61	58	55	
3	85	73	65	58	81	71	63	56	66	59	53	61	56	51	57	52	48	46	
4	77	65	55	48	74	62	54	47	58	51	45	54	48	43	51	45	41	38	
5	71	57	48	41	68	56	47	40	52	44	39	49	42	37	45	40	35	33	
6	65	52	42	36	62	50	41	35	47	39	34	44	37	32	41	35	31	29	
7	60	47	38	31	58	45	37	31	42	35	30	40	33	28	37	32	27	25	
8	56	42	34	28	54	41	33	27	39	31	26	36	30	25	34	29	24	22	
9	52	39	30	25	50	38	30	24	36	29	24	34	27	23	32	26	22	20	
10	49	36	28	22	47	35	27	22	33	26	21	31	25	21	29	24	20	18	

Candlepower		
0°	Flux	
0°	279	
5°	279	27
15°	271	76
25°	254	117
35°	230	144
45°	198	153
55°	162	145
65°	125	124
75°	90	95
85°	61	53
90°	49	27

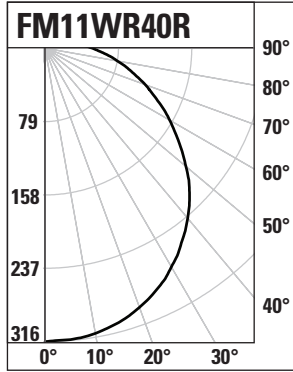

Description
11" Circular LED flush mount luminaire

CCT = 4000K
Lumens = 1162.7
Input Watts = 13.3
Efficacy = 87.4
Test Report = P27996

Zonal Lumen Summary		
Zone	Lumens	% Fixture
0°-30°	248.2	21.3
0°-40°	408.7	35.2
0°-60°	736	63.3
0°-90°	1041.5	89.6
0°-180°	1162.7	100

Coefficients of Utilization

rc	rw	Effective floor cavity reflectance 20%																	
		80%				70%				50%		30%		10%		0			
		70	50	30	10	70	50	30	10	50	30	10	50	60	10	50	30	10	0
RCR																			
0	117	117	117	117	113	113	113	113	105	105	105	99	99	99	92	92	92	90	
1	104	99	94	89	100	95	91	87	89	85	82	83	80	77	78	76	73	70	
2	94	85	77	71	90	82	75	69	77	71	66	72	67	63	67	63	60	57	
3	85	74	65	58	82	72	64	57	67	60	55	63	57	52	59	54	50	47	
4	78	65	56	49	75	63	54	48	59	52	46	56	49	44	52	47	43	40	
5	71	58	49	42	69	56	48	41	53	45	40	50	43	38	47	41	37	34	
6	66	52	43	36	63	51	42	36	48	40	35	45	38	33	43	37	32	30	
7	61	47	38	32	59	46	37	31	43	36	30	41	34	30	39	33	29	26	
8	57	43	34	28	55	42	34	28	40	32	27	38	31	26	36	30	26	23	
9	53	39	31	25	51	38	30	25	36	29	24	35	28	24	33	27	23	21	
10	50	36	28	23	48	35	28	23	34	27	22	32	26	21	30	25	21	19	

Candlepower		
0°	Flux	
0°	316	
5°	315	30
15°	306	86
25°	286	132
35°	256	160
45°	220	170
55°	176	158
65°	134	133
75°	96	102
85°	64	56
90°	51	28

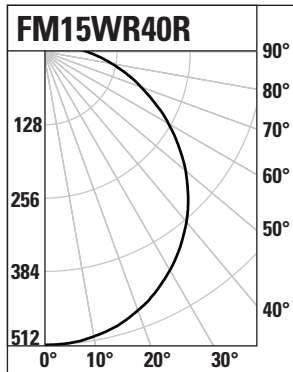

Description
15" Circular LED flush mount luminaire

CCT = 4000K
Lumens = 1880.8
Input Watts = 20.3
Efficacy = 92.7
Test Report = P27998

Zonal Lumen Summary		
Zone	Lumens	% Fixture
0°-30°	401.9	21.4
0°-40°	662.2	35.2
0°-60°	1195.4	63.6
0°-90°	1673.9	89
0°-180°	1880.8	100

Coefficients of Utilization

rc	rw	Effective floor cavity reflectance 20%																	
		80%				70%				50%		30%		10%		0			
		70	50	30	10	70	50	30	10	50	30	10	50	60	10	50	30	10	0
RCR																			
0	116	116	116	116	112	112	112	112	105	105	105	98	98	98	92	92	92	89	
1	104	99	94	89	100	95	91	87	89	85	82	83	80	78	78	76	73	70	
2	94	85	78	71	90	82	75	70	77	71	66	72	67	63	67	64	60	57	
3	85	74	66	59	82	72	64	57	67	60	55	63	57	53	59	54	50	48	
4	78	65	56	49	75	63	54	48	59	52	46	56	50	45	52	47	43	40	
5	72	58	49	42	69	56	48	41	53	46	40	50	43	38	47	41	37	35	
6	66	52	43	37	63	51	42	36	48	40	35	45	39	34	43	37	32	30	
7	61	47	38	32	59	46	38	32	43	36	31	41	34	30	39	33	29	26	
8	57	43	34	28	55	42	34	28	40	32	27	38	31	26	36	30	26	24	
9	53	39	31	25	51	38	31	25	36	29	24	35	28	24	33	27	23	21	
10	50	36	28	23	48	35	28	23	34	27	22	32	26	21	30	25	21	19	

Candlepower		
0°	Flux	
0°	512	
5°	511	49
15°	496	140
25°	463	213
35°	416	260
45°	357	275
55°	288	258
65°	215	214
75°	150	159
85°	96	84
90°	75	41

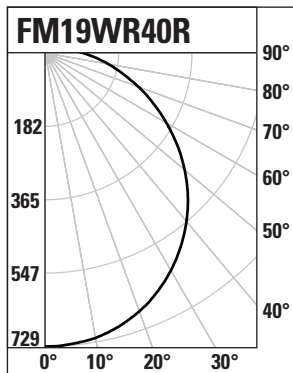

Description
19" Circular LED flush mount luminaire

CCT = 4000K
Lumens = 2552.5
Input Watts = 30.6
Efficacy = 83.4
Test Report = P28000

Zonal Lumen Summary		
Zone	Lumens	% Fixture
0°-30°	570.3	22.3
0°-40°	937.7	36.7
0°-60°	1682.5	65.9
0°-90°	2325.3	91.1
0°-180°	2552.5	100

Coefficients of Utilization

rc	rw	Effective floor cavity reflectance 20%																	
		80%				70%				50%		30%		10%		0			
		70	50	30	10	70	50	30	10	50	30	10	50	60	10	50	30	10	0
RCR																			
0	117	117	117	117	113	113	113	113	106	106	106	100	100	100	94	94	94	91	
1	105	99	95	90	101	96	92	88	90	87	83	85	82	79	80	77	75	73	
2	95	86	78	72	91	83	76	71	78	72	68	73	69	65	69	65	62	59	
3	86	75	66	59	83	73	65	58	68	62	56	64	59	54	61	56	52	49	
4	79	66	57	50	76	64	56	49	61	53	47	57	51	46	54	49	44	42	
5	72	59	50	43	69	57	49	42	54	47	41	51	45	40	48	43	38	36	
6	67	53	44	37	64	51	43	37	49	41	36	46	40	35	44	38	34	31	
7	62	48	39	33	59	47	38	32	44	37	31	42	35	31	40	34	30	28	
8	57	44	35	29	55	43	34	29	40	33	28	39	32	27	37	31	27	24	
9	54	40	32	26	52	39	31	26	37	30	25	35	29	24	34	28	24	22	
10	50	37	29	23	48	36	28	23	34	27	23	33	27	22	31	26	22	20	

Candlepower		
0°	Flux	
0°	729	
5°	726	69
15°	704	199
25°	656	303
35°	587	367
45°	501	386
55°	401	358
65°	296	294