

NEW!
More on
reverse

Fan/Fixture Box with Expandable Brackets

For Centered Installations on Cathedral Ceilings

FBX900
Fan/Fixture Box
w/ Expandable Brackets



Easy! – Slide the box along the brackets to center the fan or fixture in the room

Arlington's new **FBX900** Fan and Fixture Box provides a perfectly centered installation between two rafters – even if the desired mounting point is not in the center of the rafters.

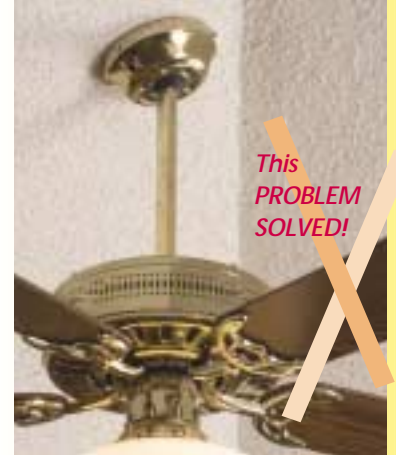

Get a centered, safe installation. Save time and money with FBX900.

- Expandable brackets hold the box securely between joists – eliminating the need to cut and nail 2X4s to center the fan or fixture
- Large, 8" square mounting surface handles newer fans with larger canopies
- Taller sides fit cathedral ceilings with angles greater than 80°

Our FB90 box is now the re-designed FB900. It offers the same improvements as FBX900.

A  
Arlington

1 Stauffer Industrial Park
Scranton, PA 18517
800/233.4717
Fax 570/562.0646
www.aifittings.com

FBX900 • FB900 • FB450 Fan/Fixture Boxes

Center a fan/fixture on cathedral ceilings w/ angles over 80°

FBX900

Remove and use these screws to attach bracket ends to rafters

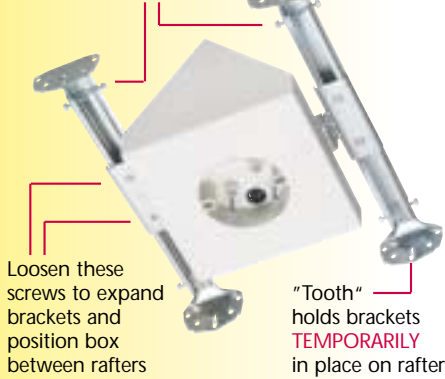

Loosen these screws to expand brackets and position box between rafters

"Tooth" holds brackets **TEMPORARILY** in place on rafter

FBX900 includes a template to level and position brackets between rafters

FBX900 Installation

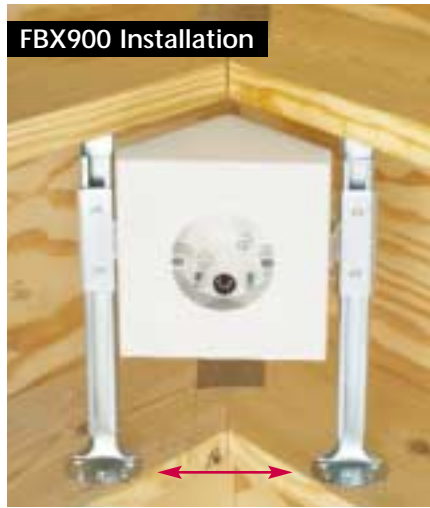

- 1 For proper fan/fixture installation, use supplied template to level and position brackets between rafters. Remove captive screws on sides of brackets and use to attach FBX900 assembly to rafters.

FB900 Installation



- 1 Cut a 2x4 approx. 14" long to span rafters. Install FB900 in center, then attach the 2x4 to the rafters, keeping bottom of box level, and short sides of box touching angled rafters.



- 2 Loosen the screws noted above. Slide box along brackets to center it between rafters. Tighten screws. Install wires.

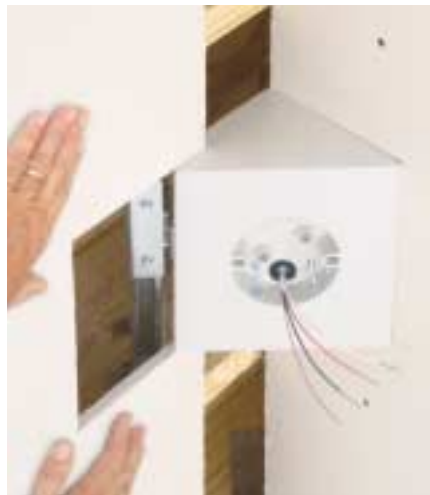

- 3 Cut and position drywall to fit around the box. (Note captive screws in box.) Install fan or fixture per manufacturer's instructions using captive installation screws.

FB450 Installation



- 1 Cut a 2x8 approx. 18" long. Install FB450 on 2x8 allowing it to extend 8-10" past the box. Keep bottom of box level, short side of box touching angled rafter. Nail or screw assembly to rafter.



Canadian orders ship w/ grounding lug required by CSA for fixtures

1 Stauffer Industrial Park
Scranton, PA 18517
800/233.4717
Fax 570/562.0646
www.aifittings.com

FBXFB900 1205/50M

Catalog Number	UPC/DEI/NAED Mfg. #018997	Description	Unit Pkg	Std Pkg
FBX900	75224	Adjustable. Fits cathedral ceilings 80 degrees, plus	1	1
FB900	75250	Fits cathedral ceilings 80 degrees, plus	1	6
FB450	75240	Fits sloped ceilings up to 45 degrees	1	6

FBX900, FB900, FB450...

- 14.5 cu. inch capacity
- All ship with captive installation screws and installed NM cable connector
- Textured, paintable surface
- **UL Ratings**
FBX900 Fan/Fixture 70 lbs
FB900, FB450 Fan 70 lbs, Fixture 200 lbs

Distributed by

Patented. Other patents pending.

NEW!
More on
reverse

Fan/Fixture Box with Expandable Brackets

For Centered Installations on Cathedral Ceilings

FBX900
Fan/Fixture Box
w/ Expandable Brackets



*Easy! – Slide the box along the brackets
to center the fan or fixture in the room*

Arlington's new **FBX900** Fan and Fixture Box provides a perfectly centered installation between two rafters – even if the desired mounting point is not in the center of the rafters.

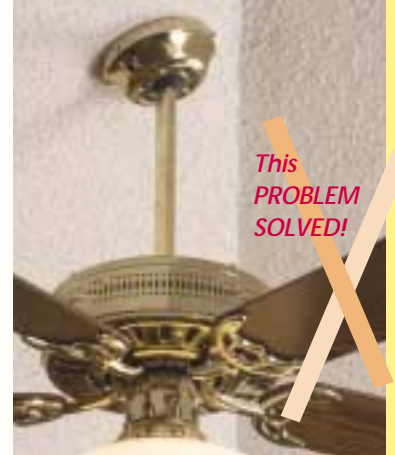

Get a centered, safe installation. Save time and money with FBX900.

- Expandable brackets hold the box securely between joists – eliminating the need to cut and nail 2X4s to center the fan or fixture
- Large, 8" square mounting surface handles newer fans with larger canopies
- Taller sides fit cathedral ceilings with angles greater than 80°

Our FB90 box is now the re-designed FB900. It offers the same improvements as FBX900.

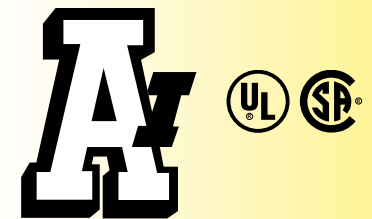

Arlington

1 Stauffer Industrial Park
Scranton, PA 18517
800/233.4717
Fax 570/562.0646
www.aifittings.com

FBX900 • FB900 • FB450 Fan/Fixture Boxes

Center a fan/fixture on cathedral ceilings w/ angles over 80°

FBX900

Remove and use these screws to attach bracket ends to rafters

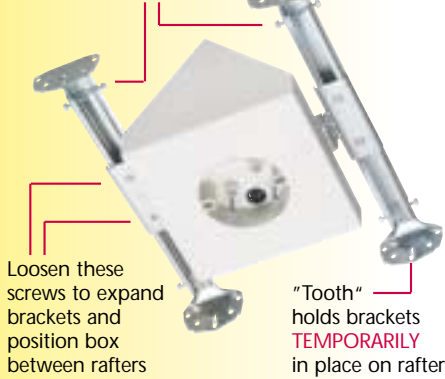

Loosen these screws to expand brackets and position box between rafters

"Tooth" holds brackets **TEMPORARILY** in place on rafter

FBX900 includes a template to level and position brackets between rafters

FBX900 Installation

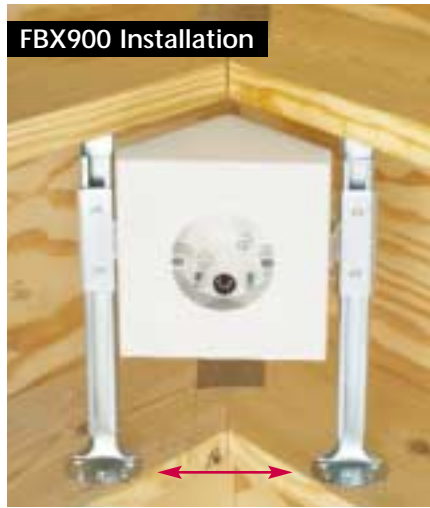

- 1 For proper fan/fixture installation, use supplied template to level and position brackets between rafters. Remove captive screws on sides of brackets and use to attach FBX900 assembly to rafters.

FB900 Installation



- 1 Cut a 2x4 approx. 14" long to span rafters. Install FB900 in center, then attach the 2x4 to the rafters, keeping bottom of box level, and short sides of box touching angled rafters.



- 2 Loosen the screws noted above. Slide box along brackets to center it between rafters. Tighten screws. Install wires.

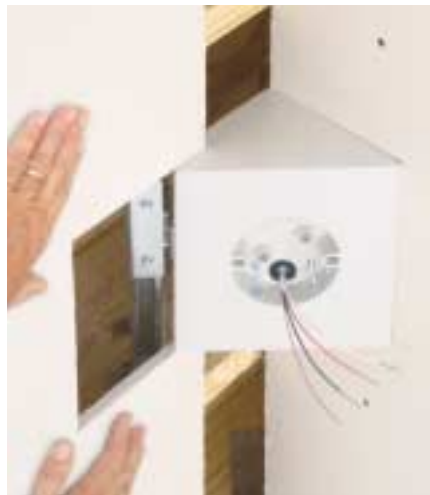

- 3 Cut and position drywall to fit around the box. (Note captive screws in box.) Install fan or fixture per manufacturer's instructions using captive installation screws.

FB450 Installation



- 1 Cut a 2x8 approx. 18" long. Install FB450 on 2x8 allowing it to extend 8-10" past the box. Keep bottom of box level, short side of box touching angled rafter. Nail or screw assembly to rafter.



Canadian orders ship w/ grounding lug required by CSA for fixtures

Arlington

1 Stauffer Industrial Park
Scranton, PA 18517
800/233.4717
Fax 570/562.0646
www.aifittings.com

FBXFB900 1205/50M

Catalog Number	UPC/DEI/NAED Mfg. #018997	Description	Unit Pkg	Std Pkg
FBX900	75224	Adjustable. Fits cathedral ceilings 80 degrees, plus	1	1
FB900	75250	Fits cathedral ceilings 80 degrees, plus	1	6
FB450	75240	Fits sloped ceilings up to 45 degrees	1	6

FBX900, FB900, FB450...

- 14.5 cu. inch capacity
- All ship with captive installation screws and installed NM cable connector
- Textured, paintable surface
- **UL Ratings**
FBX900 Fan/Fixture 70 lbs
FB900, FB450 Fan 70 lbs, Fixture 200 lbs

Distributed by

Patented. Other patents pending.