

EDS / EFS Series Control Stations

Fully Assembled EFS and EDS Factory Sealed Devices

Cl. I, Div. 1 & 2, Groups B*, C, D
Cl. II, Div. 1, Groups E, F, G
Cl. II, Div. 2, Groups F, G
Cl. III
NEMA 3, 7B*CD, 9EFG

Explosionproof
Dust-Ignitionproof
Raintight
Wet Locations

4C

Applications:

Factory sealed enclosures are installed in a rigid metallic conduit system for surface mounting adjacent to or remote from equipment being controlled and are used:

- To prevent arcing of enclosed device from causing ignition of a specific hazardous atmosphere or atmospheres external to the enclosure
- In industrial areas such as chemical plants, oil and gas refineries, paint and varnish manufacturing plants, gasoline bulk loading terminals, grain elevators, grain processing industries, coal processing or handling areas, or metal handling or finishing areas where atmosphere may contain hazardous gases and/or dust
- In non-hazardous areas where sturdy, durable enclosures are required
- In conjunction with magnetic starters or contactors for remote control of motors

Manual motor starting switch enclosures are used:

- For manual starting of small AC or DC motors
- To provide manual starting and stopping and, in the case of units with heaters, motor running protection

Features:

Factory sealed devices have many distinct advantages:

- Reduce installation problems
- Eliminate external seals
- Lower installation costs
- Improve safety
- Are used with general purpose snap and pushbutton type switches
- Standard neoprene covers for front operated pushbuttons. Prevents accumulation of dirt and entrance of water around operating shafts
- Mounting lugs and taper tapped hubs with integral bushings
- Large machine screws for fastening covers to bodies
- Lockout provisions on front operated pushbutton (marked "STOP" and "OFF") and selector switch covers
- Lockout hole for padlock having 1/4" hasp is provided when used with covers for front lever and side rocker type operation
- Close tolerances in machining of wide, mating flanges and journalled shafts and bearings for front button operation, produces flametightness of enclosure joints
- On enclosures with front lever and side rocker type operating handles, threaded type shafts and bushings are used to ensure flametightness
- Dead end (EFS or EDS) or through feed (EFSC or EDSC) hubs – 1/2" to 1" sizes
- When STOP is indicated, button is automatically red. When START is indicated, button is automatically green. Otherwise, black buttons are standard.

Certifications and Compliances:

- NEC/CEC:
 - Class I, Division 1 & 2, Groups B*, C, D
 - Class II, Division 1, Groups E, F, G
 - Class II, Division 2, Groups F, G
 - Class III
- NEMA/EEMAC: 3, 7B*CD, 9EFG
- UL Standard: 1203
- CSA Standard: C22.2 No. 30

Standard Materials:

- Bodies – *Feraloy*® iron alloy; copper-free aluminum
- Front operated pushbutton and pilot light covers – *Feraloy* iron alloy
- Side operated type pushbutton covers – copper-free aluminum
- Shafts – stainless steel
- Shaft bushings – stainless steel
- Rocker handle and pushbutton guards – type 6 / 6 nylon
- Sealing enclosures – copper-free aluminum

Standard Finishes:

- *Feraloy* iron alloy – electrogalvanized and aluminum acrylic paint
- Copper-free aluminum – natural
- Type 6 / 6 nylon – black
- Stainless steel – natural

Options:

The following special options are available from the factory by adding suffix to Cat. #:

Description	Suffix
• Momentary red emergency "STOP" button – front operated mushroom button, breaks normally closed contacts only.....	S111
• Lockout provision on front operated pushbutton cover (standard on buttons marked "OFF" and "STOP").....	S153
• For 24 VDC operation on pilot lights	S300
• Three-position selector switches with modified operation: Momentary contact clockwise operation, spring return to center, maintained contact counter-clockwise operation	S634
• Momentary contact counter-clockwise operation, spring return to center, maintained contact clockwise operation....	S635
• Bodies and covers (single and two gang units) – copper-free aluminum.....	SA
• Where indicated in the catalog listings, EDS units suitable for Class I, Division 1, Group B usage can be supplied, add suffix -GB, EFS units are suitable for Class I, Division 1, Group B as standard	GB
• Maintained red emergency "STOP" button with lockout – front operated mushroom button breaks normally closed and makes normally open contacts (push to stop), lockout standard (will not fit with a pilot light if transformer is required)	S769
• Spring return to center from right and left.....	S842

EDS bodies and factory sealed cover and device sub-assemblies are available for field assembly (see page 521).

*See suffix GB in Options section.

4C

EDS / EFS Series Control Stations

Fully Assembled EFS and EDS Factory Sealed Devices

Cl. I, Div. 1 & 2, Groups B*, C, D Explosionproof
 Cl. II, Div. 1, Groups E, F, G Dust-Ignitionproof
 Cl. II, Div. 2, Groups F, G Raintight
 Cl. III Wet Locations
 NEMA 3, 7B*CD, 9EFG

Methods of Factory Sealing

EFS/EDS Series



Factory sealed EDS and EFS pilot light, pushbutton and selector switch control stations do not need external sealing. Device contacts are factory sealed in explosionproof ESWP contact blocks. Small, compact enclosures have accurately ground wide flanges on both the body and cover for a flame-tight joint.

EDS Series

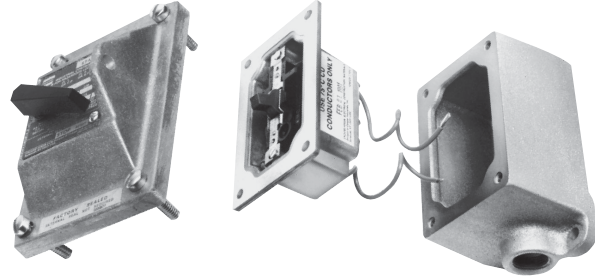

EDS factory sealed snap switches or manual motor starting switches do not need external sealing. The switches are enclosed in a unique sealing well with double flanges which mate with the cover and the body. Small, compact enclosures have accurately ground wide flanges on body, cover and sealing well for flame-tight joints. Wiring pigtails are factory sealed from under the sealing well. Reliable pouring of seals at the factory ensures safe sealing.

Dimensions (Inches) ‡

Bodies

Hub Size	Dim. "h"	Dim. "i"
1/2	3/4	13/16
3/4	7/8	13/16
1	1	15/16

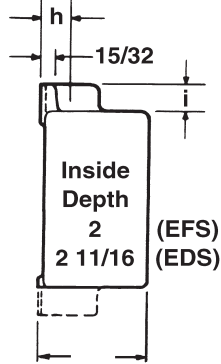

2 1/2 For EFS Series
 3 1/16 For EDS Series
 Side View

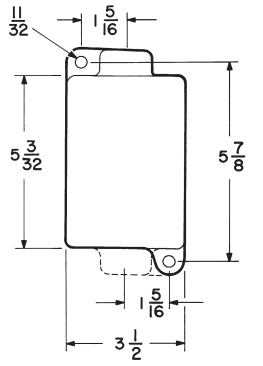

Front View - Single gang

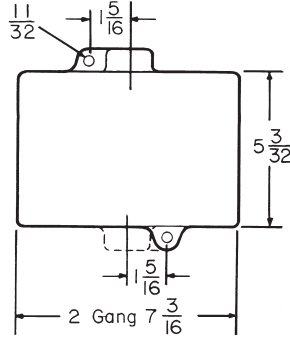

Front View - Two gang

Covers†

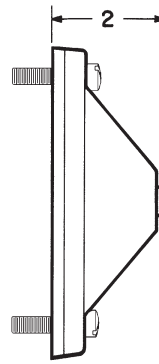

General use snap switch front operated and manual motor starting switch

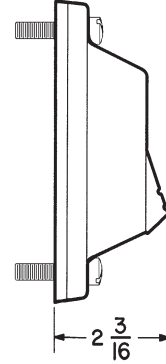

Pushbutton switch rocker type side operated



Pushbutton switch front operated

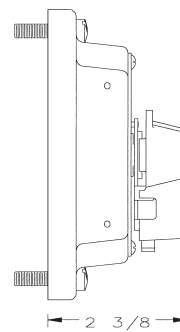

Selector switch

*See suffix GB in Options section.
 ‡Dimensions are approximate, not for construction purposes.
 † Surface covers have same length and width as bodies.

EDS / EFS Series Control Stations

Fully Assembled EDS Factory Sealed Selector Switches Maintained Contact, 600VAC Heavy Duty

Cl. I, Div. 1 & 2, Groups B*, C, D
 Cl. II, Div. 1, Groups E, F, G
 Cl. II, Div. 2, Groups F, G
 Cl. III
 NEMA 3, 7B*CD, 9EFG

Explosionproof
 Dust-Ignitionproof
 Raintight
 Wet Locations

4C

Furnished with pushbuttons, cam actuated by a maintained contact selector mechanism to operate in the sequences shown in the diagrams below. Specify indicating plate markings. See table below listings.



EDS11273

Dimensions

see page 526

Ordering Information - Single Gang

Style	Position 1	Position 2	Position 3	Replacement Contact Blocks†	Enclosure with Switch		
					Hub Size	Dead End Cat. #	Through Feed Cat. #
Two-Position, Two-Circuit	A1			ED11	1/2	EDS11271 ①	EDSC11271 ①
	A2				3/4	EDS21271 ①	EDSC21271 ①
					1	EDS31271 ①	EDSC31271 ①
Two-Position, Four-Circuit	A1			ED12	1/2	EDS11272 ①	EDSC11272 ①
	A2				3/4	EDS21272 ①	EDSC21272 ①
	B1				1	EDS31272 ①	EDSC31272 ‡
	B2						
Three-Position, Two-Circuit ‡	A1			ED11	1/2	EDS11273 ①	EDSC11273 ①
	A2				3/4	EDS21273 ①	EDSC21273 ①
Three-Position, Four-Circuit ‡	A1			ED12	1/2	EDS11274 ①	EDSC11274 ①
	A2				3/4	EDS21274 ①	EDSC21274 ①
	B1				1	EDS31274 ①	EDSC31274 ①
	A1			ED12	1/2	EDS11275 ①	EDSC11275 ①
	A2				3/4	EDS21275 ①	EDSC21275 ①
	B1				1	EDS31275 ①	EDSC31275 ①

① If desired, markings on indicating plates may be added to catalog number. Select from the list of standard markings below:

Two-Position

RUN, JOG	FAST, SLOW	IN, OUT
HAND, AUTOMATIC	OPEN, CLOSE	RAISE, LOWER
FORWARD, REVERSE	UP, DOWN	START, STOP
	ON, OFF	

Three-Position

RUN, OFF, JOG	1, OFF, 2
HAND, OFF, AUTOMATIC	OPEN, OFF, CLOSE
FORWARD, OFF, REVERSE	UP, OFF, DOWN
FAST, OFF, SLOW	

*For Class I, Group B: Consider using EFS series selector switches, see page 534. All enclosures listed above can be modified for Class I, Group B, Div. 1 usage. Add suffix GB to the Cat. No. Seals must be installed within 1/2" of each conduit opening in Division 1. These products are suitable for Group B, Div. 2 as listed, without external seals. In Canada, for Group B applications consult factory.

† For replacement contact blocks, see page 571.

‡ Suffixes S634 or S635 may be used on these catalog numbers. See page 525 for explanation of options.

4C

4C EDS / EFS Series Control Stations

**Fully Assembled EFS Factory Sealed
Selector Switches
Maintained Contact, 600VAC Heavy Duty**

Cl. I, Div. 1 & 2, Groups B*, C, D
Cl. II, Div. 1, Groups E, F, G
Cl. II, Div. 2, Groups F, G
Cl. III
NEMA 3, 7B*CD, 9EFG

Explosionproof
Dust-Ignitionproof
Raintight
Wet Locations

Furnished with pushbuttons, cam actuated by a maintained contact selector mechanism to operate in the sequences shown in the diagrams below. Specify indicating plate markings. See table below listings.



EFS11273

Dimensions
see page 526

4C

Ordering Information - Single Gang

Style	Position 1	Position 2	Position 3	Replacement Contact Blocks†	Enclosure with Switch		
					Hub Size	Dead End Cat. #	Through Feed Cat. #
Two-Position, Two-Circuit	A1			ED11	1/2	EFS11271 ①	EFSC11271 ①
	A2				3/4	EFS21271 ①	EFSC21271 ①
					1	EFS31271 ①	EFSC31271 ①
Two-Position, Four-Circuit	A1			ED12	1/2	EFS11272 ①	EFSC11272 ①
	A2				3/4	EFS21272 ①	EFSC21272 ①
	B1				1	EFS31272 ①	EFSC31272 ①
	B2						
Three-Position, Two-Circuit ‡	A1			ED11	1/2	EFS11273 ①	EFSC11273 ①
	A2				3/4	EFS21273 ①	EFSC21273 ①
					1	EFS31273 ①	EFSC31273 ①
Three-Position, Four-Circuit ‡	A1			ED12	1/2	EFS11274 ①	EFSC11274 ①
	A2				3/4	EFS21274 ①	EFSC21274 ①
	B1				1	EFS31274 ①	EFSC31274 ①
	B2						
Three-Position, Four-Circuit ‡	A1			ED12	1/2	EFS11275 ①	EFSC11275 ①
	A2				3/4	EFS21275 ①	EFSC21275 ①
	B1				1	EFS31275 ①	EFSC31275 ①
	B2						

① If desired, markings on indicating plates may be added to catalog number. Select from the list of standard markings below:

Two-Position

RUN, JOG	FAST, SLOW	IN, OUT
HAND, AUTOMATIC	OPEN, CLOSE	RAISE, LOWER
FORWARD, REVERSE	UP, DOWN	START, STOP
	ON, OFF	

Three-Position

RUN, OFF, JOG	1, OFF, 2
HAND, OFF, AUTOMATIC	OPEN, OFF, CLOSE
FORWARD, OFF, REVERSE	UP, OFF, DOWN
FAST, OFF, SLOW	

*Class I, Group B: All enclosures listed above are suitable for Class I, Group B, Div. 1 usage. Seals only have to be installed on 1 inch conduit within 5 ft. in Division 1.
† For replacement contact blocks, see page 571.
‡ Suffixes S634 or S635 may be used on these catalog numbers. See page 525 for explanation of options.

EDS / EFS Series Control Stations

Sub-assembly Reference Guide

For a complete list of components for EDS & EFS Control Stations, see page 514 for FlexStation™ Series

4C

Control Stations and their Sub-assemblies

Complete Control Station	Sub-assembly		Notes and Requirements
	Cover & Device	Cast Back Box	
PUSHBUTTONS			
EDS2184	DSD918	EDS271	
EDSC2184	DSD918	EDSC271	
EDS215	DSD922	EDS271	Start/ Stop Legend included
EDSC215	DSD922	EDSC271	Start/ Stop Legend included
EDS2190	DSD921	EDS271	
EDSC2190	DSD921	EDSC271	
EDS2184-S769-EM-SP	DSD918-S769-EM-SP	EDS271	Emergency Stop Legend included
EDSC2184-S769-EM-SP	DSD918-S769-EM-SP	EDSC271	Emergency Stop Legend included
EDS2284	(2) DSD918	EDS272	
EDSC2284	(2) DSD918	EDSC272	
EDS225	(2) DSD922	EDS272	Start/ Stop Legend included
EDSC225	(2) DSD922	EDSC272	Start/ Stop Legend included
EDS2290	(2) DSD921	EDS272	
EDSC2290	(2) DSD921	EDSC272	
PILOT LIGHTS			
EFS21524-J*	DSD948-J*	EDS271 †	* Insert pilot light color † When using the EFS Series pilot light in Cl. I, Div. 1, Group B applications, the EFS back box is required in place of the EDS.
EFSC21524-J*	DSD948-J*	EDSC271 †	
EFS21561-J*-J*	DSD947-J*-J*	EDS271 †	
EFSC21561-J*-J*	DSD947-J*-J*	EDSC271 †	
PUSHBUTTON / PILOT LIGHT COMBINATIONS			
EDS21473-J*	DSD958-J*	EDS271	* Insert pilot light color
EDSC21473-J*	DSD958-J*	EDSC271	* Insert pilot light color
EDS22471-J*	DSD948-J* & DSD921	EDS272	* Insert pilot light color
EDSC22471-J*	DSD948-J* & DSD921	EDSC272	* Insert pilot light color
EDS22868-J*-J*	DSD947-J*-J* & DSD921	EDS272	* Insert pilot light color
EDSC22868-J*-J*	DSD947-J*-J* & DSD921	EDSC272	* Insert pilot light color
SELECTOR SWITCHES			
EDS21271	DSD923	EDS271	
EDSC21271	DSD923	EDSC271	
EDS21272	DSD924	EDS271	
EDSC21272	DSD924	EDSC271	
EDS21273	DSD925	EDS271	
EDSC21273	DSD925	EDSC271	
EDS21274	DSD926	EDS271	
EDSC21274	DSD926	EDSC271	
EDS21275	DSD927	EDS271	
EDSC21275	DSD927	EDSC271	
MANUAL MOTOR STARTER WITH O/L			
EDS21101	DS415A & SW13	EDS271	"-W * " for heater, or "-0" distributor provided
EDSC21101	DS415A & SW13	EDSC271	"-W * " for heater, or "-0" distributor provided
EDS21102	DS415A & SW14	EDS271	"-W * " for heater, or "-0" distributor provided
EDSC21102	DS415A & SW14	EDSC271	"-W * " for heater, or "-0" distributor provided
EDS21093	DS415A & SW11	EDS271	"-G * " for heater, or "-0" distributor provided
EDSC21093	DS415A & SW11	EDSC271	"-G * " for heater, or "-0" distributor provided
EDS21094	DS415A & SW12	EDS271	"-G * " for heater, or "-0" distributor provided
EDSC21094	DS415A & SW12	EDSC271	"-G * " for heater, or "-0" distributor provided
EDS2199	DS415A & SW9	EDS271	"-P * " for heater, or "-0" distributor provided
EDSC2199	DS415A & SW9	EDSC271	"-P * " for heater, or "-0" distributor provided
EDS21100	DS415A & SW10	EDS271	"-P * " for heater, or "-0" distributor provided
EDSC21100	DS415A & SW10	EDSC271	"-P * " for heater, or "-0" distributor provided

4C

Sub-assembly Reference Guide

Control Stations and their Sub-assemblies

Complete Control Station	Sub-assembly		Notes and Requirements
	Cover & Device	Cast Back Box	
MANUAL MOTOR STARTER			
EFD218-T8	DSD916	EDS271	
Alternative	DS415A & SQ D 2510 KO-1	EDS271	SQ D switch provided by distributor
EFDC218-T8	DSD916	EDSC271	
Alternative	DS415A & SQ D 2510 KO-1	EDSC271	SQ D switch provided by distributor
EFD2419	DSD917	EDS271	
Alternative	DS415A & GE 2368S	EDS271	GE switch provided by distributor
EFDC2419	DSD917	EDSC271	
Alternative	DS415A & GE 2368S	EDSC271	GE switch provided by distributor
SNAP SWITCHES			
EDS2129	DS652 & SW5	EDS271	
Alternative	DSD933	EDS271	External Sealing Fitting Required
EDSC2129	DS652 & SW5	EDSC271	
Alternative	DSD933	EDSC271	External Sealing Fitting Required
EDS218	DS652 & SW6	EDS271	
Alternative	DSD634	EDS271	External Sealing Fitting Required
EDSC218	DS652 & SW6	EDSC271	
Alternative	DSD634	EDSC271	External Sealing Fitting Required
EDS2130	DS652 & SW7	EDS271	
Alternative	DSD936	EDS271	External Sealing Fitting Required
EDSC2130	DS652 & SW7	EDSC271	
Alternative	DSD936	EDSC271	External Sealing Fitting Required
EDS2140	DS652 & SW8	EDS271	
Alternative	DSD937	EDS271	External Sealing Fitting Required
EDSC2140	DS652 & SW8	EDSC271	
Alternative	DSD937	EDSC271	External Sealing Fitting Required
EDS2229	(2) DS652 & (2) SW5	EDS272	
Alternative	(2) DSD933	EDS272	External Sealing Fitting Required
EDSC2229	(2) DS652 & (2) SW5	EDSC272	
Alternative	(2) DSD933	EDSC272	External Sealing Fitting Required
EDSC228	(2) DS652 & (2) SW6	EDSC272	
Alternative	(2) DSD634	EDSC272	External Sealing Fitting Required
EDS2230	(2) DS652 & (2) SW7	EDS272	
Alternative	(2) DSD936	EDS272	External Sealing Fitting Required
EDSC2230	(2) DS652 & (2) SW7	EDSC272	
Alternative	(2) DSD936	EDSC272	External Sealing Fitting Required
EDSC2240	(2) DS652 & (2) SW8	EDSC272	
Alternative	(2) DSD937	EDSC272	External Sealing Fitting Required
ROCKER SWITCHES			
EDS2596	DSD949	EDS271	
EDSC2596	DSD949	EDSC271	
EDS2162	DSD951	EDS271	Start/ Stop Legend included
EDSC2162	DSD951	EDSC271	Start/ Stop Legend included
EDS2194	DSD950	EDS271	
EDSC2194	DSD950	EDSC271	
EDS2696	(2) DSD949	EDS272	Start/ Stop Legend included
EDSC2696	(2) DSD949	EDSC272	Start/ Stop Legend included
EDS2262	(2) DSD951	EDS272	
EDSC2262	(2) DSD951	EDSC272	
EDS2294	(2) DSD950	EDS272	
EDSC2294	(2) DSD950	EDSC272	

Additional notes:

- See Eaton's Crouse-Hinds' installation instructions for any possible additional sealing requirements.
- Part numbers listed with 3/4" hub in back box (Ex. EDS2184). For 1/2" hub, change the "2" to "1" (EDS1184). For 1" hub, change the "2" to "3" (EDS3184).
- Control Stations with "Stop" legend have lockout provided as standard.
- Pilot Light Colors J*- J1= Red, J3= Green, J6= Amber, J10= Clear, J11= Blue. LED pilot lights are available with LED suffix.
- Pilot Light Transformers for voltages over 125V. Suffix T2= 240/220 - 110V, T4= 480/440 - 110V, T5= 600/500 - 110V (not available on double pilot cover).
- Standard legend plate markings are available by adding nomenclature after the part number (EDS2184-Run).
- Selector switch nameplate kits available. 2-Pos = "SS2KIT", 3-Pos = "SS3KIT". See Replacement Parts book for additional information.
- Copper-free aluminum bodies and covers available with SA suffix.
- Additional control station options may be found in Section 4C.
- Group B ratings may be achieved by adding the GB suffix or using the EFS back box. See part number instructions for the item required.
- Group B ratings may already be achieved when used in Class I, Division 2 applications. See Certifications and Compliances for item required.
- Additional control station configurations available through the FlexStation Component Series.

EDS / EFS Series Control Stations

Fully Assembled EFS and EDS Factory Sealed Devices

Cl. I, Div. 1 & 2, Groups B*, C, D
Cl. II, Div. 1, Groups E, F, G
Cl. II, Div. 2, Groups F, G
Cl. III
NEMA 3, 7B*CD, 9EFG

Explosionproof
Dust-Ignitionproof
Raintight
Wet Locations

4C

Applications:

Factory sealed enclosures are installed in a rigid metallic conduit system for surface mounting adjacent to or remote from equipment being controlled and are used:

- To prevent arcing of enclosed device from causing ignition of a specific hazardous atmosphere or atmospheres external to the enclosure
- In industrial areas such as chemical plants, oil and gas refineries, paint and varnish manufacturing plants, gasoline bulk loading terminals, grain elevators, grain processing industries, coal processing or handling areas, or metal handling or finishing areas where atmosphere may contain hazardous gases and/or dust
- In non-hazardous areas where sturdy, durable enclosures are required
- In conjunction with magnetic starters or contactors for remote control of motors

Manual motor starting switch enclosures are used:

- For manual starting of small AC or DC motors
- To provide manual starting and stopping and, in the case of units with heaters, motor running protection

Features:

Factory sealed devices have many distinct advantages:

- Reduce installation problems
- Eliminate external seals
- Lower installation costs
- Improve safety
- Are used with general purpose snap and pushbutton type switches
- Standard neoprene covers for front operated pushbuttons. Prevents accumulation of dirt and entrance of water around operating shafts
- Mounting lugs and taper tapped hubs with integral bushings
- Large machine screws for fastening covers to bodies
- Lockout provisions on front operated pushbutton (marked "STOP" and "OFF") and selector switch covers
- Lockout hole for padlock having 1/4" hasp is provided when used with covers for front lever and side rocker type operation
- Close tolerances in machining of wide, mating flanges and journalled shafts and bearings for front button operation, produces flametightness of enclosure joints
- On enclosures with front lever and side rocker type operating handles, threaded type shafts and bushings are used to ensure flametightness
- Dead end (EFS or EDS) or through feed (EFSC or EDSC) hubs – 1/2" to 1" sizes
- When STOP is indicated, button is automatically red. When START is indicated, button is automatically green. Otherwise, black buttons are standard.

Certifications and Compliances:

- NEC/CEC:
 - Class I, Division 1 & 2, Groups B*, C, D
 - Class II, Division 1, Groups E, F, G
 - Class II, Division 2, Groups F, G
 - Class III
- NEMA/EEMAC: 3, 7B*CD, 9EFG
- UL Standard: 1203
- CSA Standard: C22.2 No. 30

Standard Materials:

- Bodies – *Feraloy*® iron alloy; copper-free aluminum
- Front operated pushbutton and pilot light covers – *Feraloy* iron alloy
- Side operated type pushbutton covers – copper-free aluminum
- Shafts – stainless steel
- Shaft bushings – stainless steel
- Rocker handle and pushbutton guards – type 6 / 6 nylon
- Sealing enclosures – copper-free aluminum

Standard Finishes:

- *Feraloy* iron alloy – electrogalvanized and aluminum acrylic paint
- Copper-free aluminum – natural
- Type 6 / 6 nylon – black
- Stainless steel – natural

Options:

The following special options are available from the factory by adding suffix to Cat. #:

Description	Suffix
• Momentary red emergency "STOP" button – front operated mushroom button, breaks normally closed contacts only.....	S111
• Lockout provision on front operated pushbutton cover (standard on buttons marked "OFF" and "STOP").....	S153
• For 24 VDC operation on pilot lights	S300
• Three-position selector switches with modified operation: Momentary contact clockwise operation, spring return to center, maintained contact counter-clockwise operation	S634
• Momentary contact counter-clockwise operation, spring return to center, maintained contact clockwise operation....	S635
• Bodies and covers (single and two gang units) – copper-free aluminum.....	SA
• Where indicated in the catalog listings, EDS units suitable for Class I, Division 1, Group B usage can be supplied, add suffix -GB, EFS units are suitable for Class I, Division 1, Group B as standard	GB
• Maintained red emergency "STOP" button with lockout – front operated mushroom button breaks normally closed and makes normally open contacts (push to stop), lockout standard (will not fit with a pilot light if transformer is required)	S769
• Spring return to center from right and left.....	S842

EDS bodies and factory sealed cover and device sub-assemblies are available for field assembly (see page 521).

*See suffix GB in Options section.

4C

EDS / EFS Series Control Stations

Fully Assembled EFS and EDS Factory Sealed Devices

Cl. I, Div. 1 & 2, Groups B*, C, D Explosionproof
 Cl. II, Div. 1, Groups E, F, G Dust-Ignitionproof
 Cl. II, Div. 2, Groups F, G Raintight
 Cl. III Wet Locations
 NEMA 3, 7B*CD, 9EFG

Methods of Factory Sealing

EFS/EDS Series

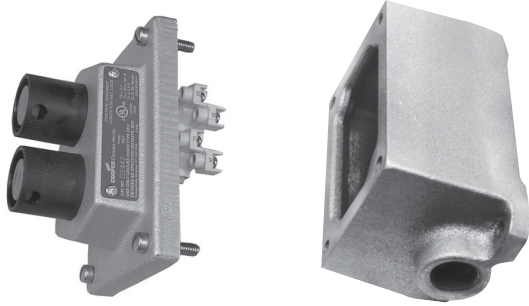

Factory sealed EDS and EFS pilot light, pushbutton and selector switch control stations do not need external sealing. Device contacts are factory sealed in explosionproof ESWP contact blocks. Small, compact enclosures have accurately ground wide flanges on both the body and cover for a flame-tight joint.

EDS Series

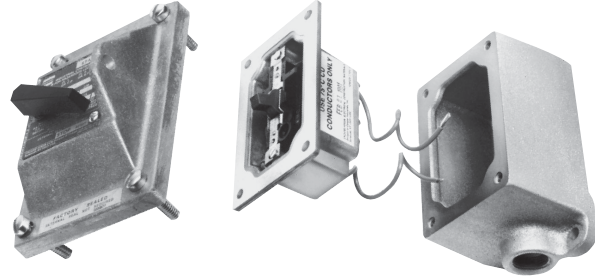

EDS factory sealed snap switches or manual motor starting switches do not need external sealing. The switches are enclosed in a unique sealing well with double flanges which mate with the cover and the body. Small, compact enclosures have accurately ground wide flanges on body, cover and sealing well for flame-tight joints. Wiring pigtails are factory sealed from under the sealing well. Reliable pouring of seals at the factory ensures safe sealing.

Dimensions (Inches) ‡

Bodies

Hub Size	Dim. "h"	Dim. "i"
1/2	3/4	13/16
3/4	7/8	13/16
1	1	15/16

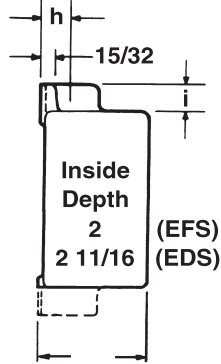

2 1/2 For EFS Series
 3 1/16 For EDS Series

Side View

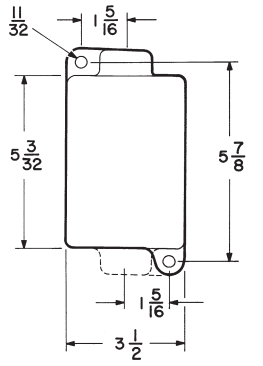

Front View - Single gang

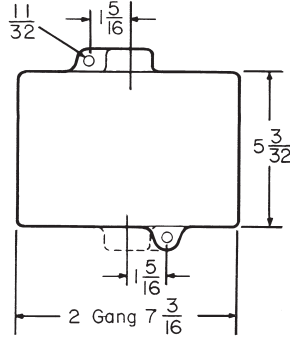

Front View - Two gang

Covers†

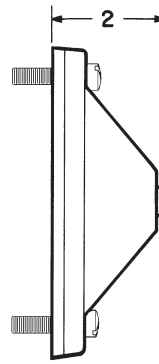

General use snap switch front operated and manual motor starting switch

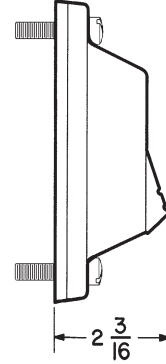

Pushbutton switch rocker type side operated



Pushbutton switch front operated

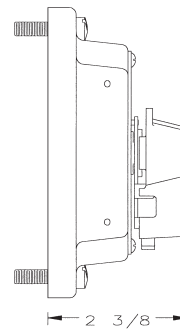

Selector switch

*See suffix GB in Options section.
 ‡Dimensions are approximate, not for construction purposes.
 † Surface covers have same length and width as bodies.

EDS / EFS Series Control Stations

Fully Assembled EDS Factory Sealed Selector Switches Maintained Contact, 600VAC Heavy Duty

Cl. I, Div. 1 & 2, Groups B*, C, D
 Cl. II, Div. 1, Groups E, F, G
 Cl. II, Div. 2, Groups F, G
 Cl. III
 NEMA 3, 7B*CD, 9EFG

Explosionproof
 Dust-Ignitionproof
 Raintight
 Wet Locations

4C

Furnished with pushbuttons, cam actuated by a maintained contact selector mechanism to operate in the sequences shown in the diagrams below. Specify indicating plate markings. See table below listings.



EDS11273

Dimensions

see page 526

Ordering Information - Single Gang

Style	Position 1	Position 2	Position 3	Replacement Contact Blocks†	Enclosure with Switch		
					Hub Size	Dead End Cat. #	Through Feed Cat. #
Two-Position, Two-Circuit	A1			ED11	1/2	EDS11271 ①	EDSC11271 ①
	A2				3/4	EDS21271 ①	EDSC21271 ①
					1	EDS31271 ①	EDSC31271 ①
Two-Position, Four-Circuit	A1			ED12	1/2	EDS11272 ①	EDSC11272 ①
	A2				3/4	EDS21272 ①	EDSC21272 ①
	B1				1	EDS31272 ①	EDSC31272 ①
	B2						
Three-Position, Two-Circuit ‡	A1			ED11	1/2	EDS11273 ①	EDSC11273 ①
	A2				3/4	EDS21273 ①	EDSC21273 ①
Three-Position, Four-Circuit ‡	A1			ED12	1/2	EDS11274 ①	EDSC11274 ①
	A2				3/4	EDS21274 ①	EDSC21274 ①
	B1				1	EDS31274 ①	EDSC31274 ①
	B2						
Three-Position, Four-Circuit ‡	A1			ED12	1/2	EDS11275 ①	EDSC11275 ①
	A2				3/4	EDS21275 ①	EDSC21275 ①
	B1				1	EDS31275 ①	EDSC31275 ①
	B2						

① If desired, markings on indicating plates may be added to catalog number. Select from the list of standard markings below:

Two-Position

RUN, JOG	FAST, SLOW	IN, OUT
HAND, AUTOMATIC	OPEN, CLOSE	RAISE, LOWER
FORWARD, REVERSE	UP, DOWN	START, STOP
	ON, OFF	

Three-Position

RUN, OFF, JOG	1, OFF, 2
HAND, OFF, AUTOMATIC	OPEN, OFF, CLOSE
FORWARD, OFF, REVERSE	UP, OFF, DOWN
FAST, OFF, SLOW	

*For Class I, Group B: Consider using EFS series selector switches, see page 534. All enclosures listed above can be modified for Class I, Group B, Div. 1 usage. Add suffix GB to the Cat. No. Seals must be installed within 1/2" of each conduit opening in Division 1. These products are suitable for Group B, Div. 2 as listed, without external seals. In Canada, for Group B applications consult factory.

† For replacement contact blocks, see page 571.

‡ Suffixes S634 or S635 may be used on these catalog numbers. See page 525 for explanation of options.

4C

4C EDS / EFS Series Control Stations

**Fully Assembled EFS Factory Sealed
Selector Switches
Maintained Contact, 600VAC Heavy Duty**

Cl. I, Div. 1 & 2, Groups B*, C, D
Cl. II, Div. 1, Groups E, F, G
Cl. II, Div. 2, Groups F, G
Cl. III
NEMA 3, 7B*CD, 9EFG

Explosionproof
Dust-Ignitionproof
Raintight
Wet Locations

Furnished with pushbuttons, cam actuated by a maintained contact selector mechanism to operate in the sequences shown in the diagrams below. Specify indicating plate markings. See table below listings.



EFS11273

Dimensions
see page 526

4C

Ordering Information - Single Gang

Style	Position 1	Position 2	Position 3	Replacement Contact Blocks†	Enclosure with Switch		
					Hub Size	Dead End Cat. #	Through Feed Cat. #
Two-Position, Two-Circuit	A1			ED11	1/2	EFS11271 ①	EFSC11271 ①
	A2				3/4	EFS21271 ①	EFSC21271 ①
					1	EFS31271 ①	EFSC31271 ①
Two-Position, Four-Circuit	A1			ED12	1/2	EFS11272 ①	EFSC11272 ①
	A2				3/4	EFS21272 ①	EFSC21272 ①
	B1				1	EFS31272 ①	EFSC31272 ①
	B2						
Three-Position, Two-Circuit ‡	A1			ED11	1/2	EFS11273 ①	EFSC11273 ①
	A2				3/4	EFS21273 ①	EFSC21273 ①
					1	EFS31273 ①	EFSC31273 ①
Three-Position, Four-Circuit ‡	A1			ED12	1/2	EFS11274 ①	EFSC11274 ①
	A2				3/4	EFS21274 ①	EFSC21274 ①
	B1				1	EFS31274 ①	EFSC31274 ①
	B2						
	A1			ED12	1/2	EFS11275 ①	EFSC11275 ①
	A2				3/4	EFS21275 ①	EFSC21275 ①
B1	1				EFS31275 ①	EFSC31275 ①	
B2							

① If desired, markings on indicating plates may be added to catalog number. Select from the list of standard markings below:

Two-Position

RUN, JOG	FAST, SLOW	IN, OUT
HAND, AUTOMATIC	OPEN, CLOSE	RAISE, LOWER
FORWARD, REVERSE	UP, DOWN	START, STOP
	ON, OFF	

Three-Position

RUN, OFF, JOG	1, OFF, 2
HAND, OFF, AUTOMATIC	OPEN, OFF, CLOSE
FORWARD, OFF, REVERSE	UP, OFF, DOWN
FAST, OFF, SLOW	

*Class I, Group B: All enclosures listed above are suitable for Class I, Group B, Div. 1 usage. Seals only have to be installed on 1 inch conduit within 5 ft. in Division 1.
† For replacement contact blocks, see page 571.
‡ Suffixes S634 or S635 may be used on these catalog numbers. See page 525 for explanation of options.

EDS / EFS Series Control Stations

Sub-assembly Reference Guide

For a complete list of components for EDS & EFS Control Stations, see page 514 for FlexStation™ Series

4C

Control Stations and their Sub-assemblies

Complete Control Station	Sub-assembly		Notes and Requirements
	Cover & Device	Cast Back Box	
PUSHBUTTONS			
EDS2184	DSD918	EDS271	
EDSC2184	DSD918	EDSC271	
EDS215	DSD922	EDS271	Start/ Stop Legend included
EDSC215	DSD922	EDSC271	Start/ Stop Legend included
EDS2190	DSD921	EDS271	
EDSC2190	DSD921	EDSC271	
EDS2184-S769-EM-SP	DSD918-S769-EM-SP	EDS271	Emergency Stop Legend included
EDSC2184-S769-EM-SP	DSD918-S769-EM-SP	EDSC271	Emergency Stop Legend included
EDS2284	(2) DSD918	EDS272	
EDSC2284	(2) DSD918	EDSC272	
EDS225	(2) DSD922	EDS272	Start/ Stop Legend included
EDSC225	(2) DSD922	EDSC272	Start/ Stop Legend included
EDS2290	(2) DSD921	EDS272	
EDSC2290	(2) DSD921	EDSC272	
PILOT LIGHTS			
EFS21524-J*	DSD948-J*	EDS271 †	* Insert pilot light color † When using the EFS Series pilot light in Cl. I, Div. 1, Group B applications, the EFS back box is required in place of the EDS.
EFSC21524-J*	DSD948-J*	EDSC271 †	
EFS21561-J*-J*	DSD947-J*-J*	EDS271 †	
EFSC21561-J*-J*	DSD947-J*-J*	EDSC271 †	
PUSHBUTTON / PILOT LIGHT COMBINATIONS			
EDS21473-J*	DSD958-J*	EDS271	* Insert pilot light color
EDSC21473-J*	DSD958-J*	EDSC271	* Insert pilot light color
EDS22471-J*	DSD948-J* & DSD921	EDS272	* Insert pilot light color
EDSC22471-J*	DSD948-J* & DSD921	EDSC272	* Insert pilot light color
EDS22868-J*-J*	DSD947-J*-J* & DSD921	EDS272	* Insert pilot light color
EDSC22868-J*-J*	DSD947-J*-J* & DSD921	EDSC272	* Insert pilot light color
SELECTOR SWITCHES			
EDS21271	DSD923	EDS271	
EDSC21271	DSD923	EDSC271	
EDS21272	DSD924	EDS271	
EDSC21272	DSD924	EDSC271	
EDS21273	DSD925	EDS271	
EDSC21273	DSD925	EDSC271	
EDS21274	DSD926	EDS271	
EDSC21274	DSD926	EDSC271	
EDS21275	DSD927	EDS271	
EDSC21275	DSD927	EDSC271	
MANUAL MOTOR STARTER WITH O/L			
EDS21101	DS415A & SW13	EDS271	"-W * " for heater, or "-0" distributor provided
EDSC21101	DS415A & SW13	EDSC271	"-W * " for heater, or "-0" distributor provided
EDS21102	DS415A & SW14	EDS271	"-W * " for heater, or "-0" distributor provided
EDSC21102	DS415A & SW14	EDSC271	"-W * " for heater, or "-0" distributor provided
EDS21093	DS415A & SW11	EDS271	"-G * " for heater, or "-0" distributor provided
EDSC21093	DS415A & SW11	EDSC271	"-G * " for heater, or "-0" distributor provided
EDS21094	DS415A & SW12	EDS271	"-G * " for heater, or "-0" distributor provided
EDSC21094	DS415A & SW12	EDSC271	"-G * " for heater, or "-0" distributor provided
EDS2199	DS415A & SW9	EDS271	"-P * " for heater, or "-0" distributor provided
EDSC2199	DS415A & SW9	EDSC271	"-P * " for heater, or "-0" distributor provided
EDS21100	DS415A & SW10	EDS271	"-P * " for heater, or "-0" distributor provided
EDSC21100	DS415A & SW10	EDSC271	"-P * " for heater, or "-0" distributor provided

4C

Sub-assembly
Reference Guide

Control Stations and their Sub-assemblies

Complete Control Station	Sub-assembly		Notes and Requirements
	Cover & Device	Cast Back Box	
MANUAL MOTOR STARTER			
EFD218-T8	DSD916	EDS271	
Alternative	DS415A & SQ D 2510 KO-1	EDS271	SQ D switch provided by distributor
EFDC218-T8	DSD916	EDSC271	
Alternative	DS415A & SQ D 2510 KO-1	EDSC271	SQ D switch provided by distributor
EFD2419	DSD917	EDS271	
Alternative	DS415A & GE 2368S	EDS271	GE switch provided by distributor
EFDC2419	DSD917	EDSC271	
Alternative	DS415A & GE 2368S	EDSC271	GE switch provided by distributor
SNAP SWITCHES			
EDS2129	DS652 & SW5	EDS271	
Alternative	DSD933	EDS271	External Sealing Fitting Required
EDSC2129	DS652 & SW5	EDSC271	
Alternative	DSD933	EDSC271	External Sealing Fitting Required
EDS218	DS652 & SW6	EDS271	
Alternative	DSD634	EDS271	External Sealing Fitting Required
EDSC218	DS652 & SW6	EDSC271	
Alternative	DSD634	EDSC271	External Sealing Fitting Required
EDS2130	DS652 & SW7	EDS271	
Alternative	DSD936	EDS271	External Sealing Fitting Required
EDSC2130	DS652 & SW7	EDSC271	
Alternative	DSD936	EDSC271	External Sealing Fitting Required
EDS2140	DS652 & SW8	EDS271	
Alternative	DSD937	EDS271	External Sealing Fitting Required
EDSC2140	DS652 & SW8	EDSC271	
Alternative	DSD937	EDSC271	External Sealing Fitting Required
EDS2229	(2) DS652 & (2) SW5	EDS272	
Alternative	(2) DSD933	EDS272	External Sealing Fitting Required
EDSC2229	(2) DS652 & (2) SW5	EDSC272	
Alternative	(2) DSD933	EDSC272	External Sealing Fitting Required
EDSC228	(2) DS652 & (2) SW6	EDSC272	
Alternative	(2) DSD634	EDSC272	External Sealing Fitting Required
EDS2230	(2) DS652 & (2) SW7	EDS272	
Alternative	(2) DSD936	EDS272	External Sealing Fitting Required
EDSC2230	(2) DS652 & (2) SW7	EDSC272	
Alternative	(2) DSD936	EDSC272	External Sealing Fitting Required
EDSC2240	(2) DS652 & (2) SW8	EDSC272	
Alternative	(2) DSD937	EDSC272	External Sealing Fitting Required
ROCKER SWITCHES			
EDS2596	DSD949	EDS271	
EDSC2596	DSD949	EDSC271	
EDS2162	DSD951	EDS271	Start/ Stop Legend included
EDSC2162	DSD951	EDSC271	Start/ Stop Legend included
EDS2194	DSD950	EDS271	
EDSC2194	DSD950	EDSC271	
EDS2696	(2) DSD949	EDS272	Start/ Stop Legend included
EDSC2696	(2) DSD949	EDSC272	Start/ Stop Legend included
EDS2262	(2) DSD951	EDS272	
EDSC2262	(2) DSD951	EDSC272	
EDS2294	(2) DSD950	EDS272	
EDSC2294	(2) DSD950	EDSC272	

Additional notes:

- See Eaton's Crouse-Hinds' installation instructions for any possible additional sealing requirements.
- Part numbers listed with 3/4" hub in back box (Ex. EDS2184). For 1/2" hub, change the "2" to "1" (EDS1184). For 1" hub, change the "2" to "3" (EDS3184).
- Control Stations with "Stop" legend have lockout provided as standard.
- Pilot Light Colors J*- J1= Red, J3= Green, J6= Amber, J10= Clear, J11= Blue. LED pilot lights are available with LED suffix.
- Pilot Light Transformers for voltages over 125V. Suffix T2= 240/220 - 110V, T4= 480/440 - 110V, T5= 600/500 - 110V (not available on double pilot cover).
- Standard legend plate markings are available by adding nomenclature after the part number (EDS2184-Run).
- Selector switch nameplate kits available. 2-Pos = "SS2KIT", 3-Pos = "SS3KIT". See Replacement Parts book for additional information.
- Copper-free aluminum bodies and covers available with SA suffix.
- Additional control station options may be found in Section 4C.
- Group B ratings may be achieved by adding the GB suffix or using the EFS back box. See part number instructions for the item required.
- Group B ratings may already be achieved when used in Class I, Division 2 applications. See Certifications and Compliances for item required.
- Additional control station configurations available through the FlexStation Component Series.