

SCALE 1.000

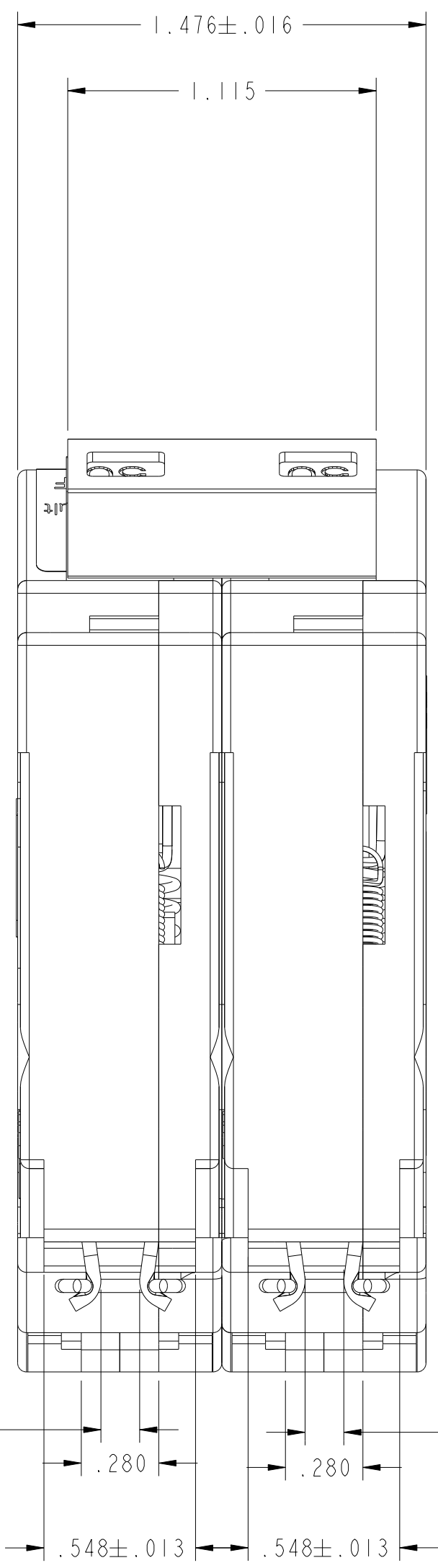

OPENING WILL ACCEPT A 3/16 DIA PIN

OPENING WILL ACCEPT A 3/16 DIA PIN

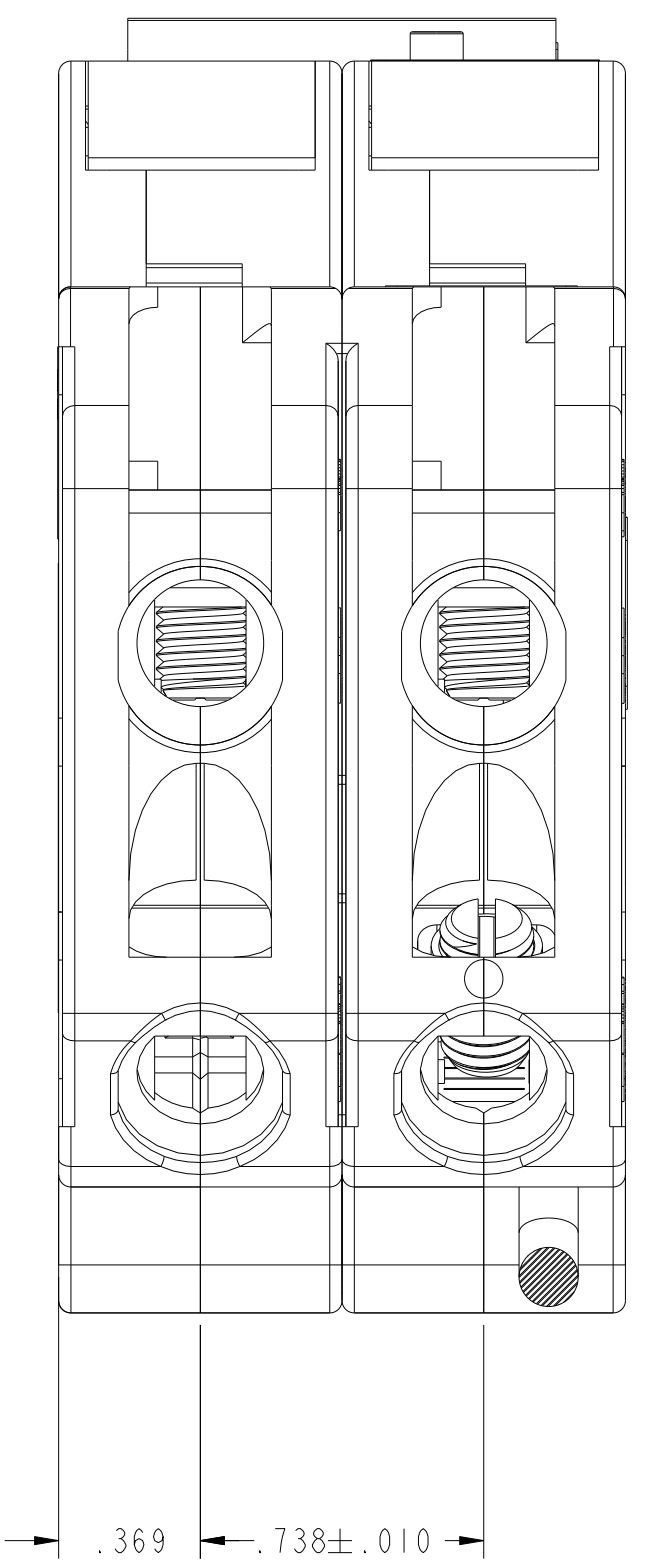
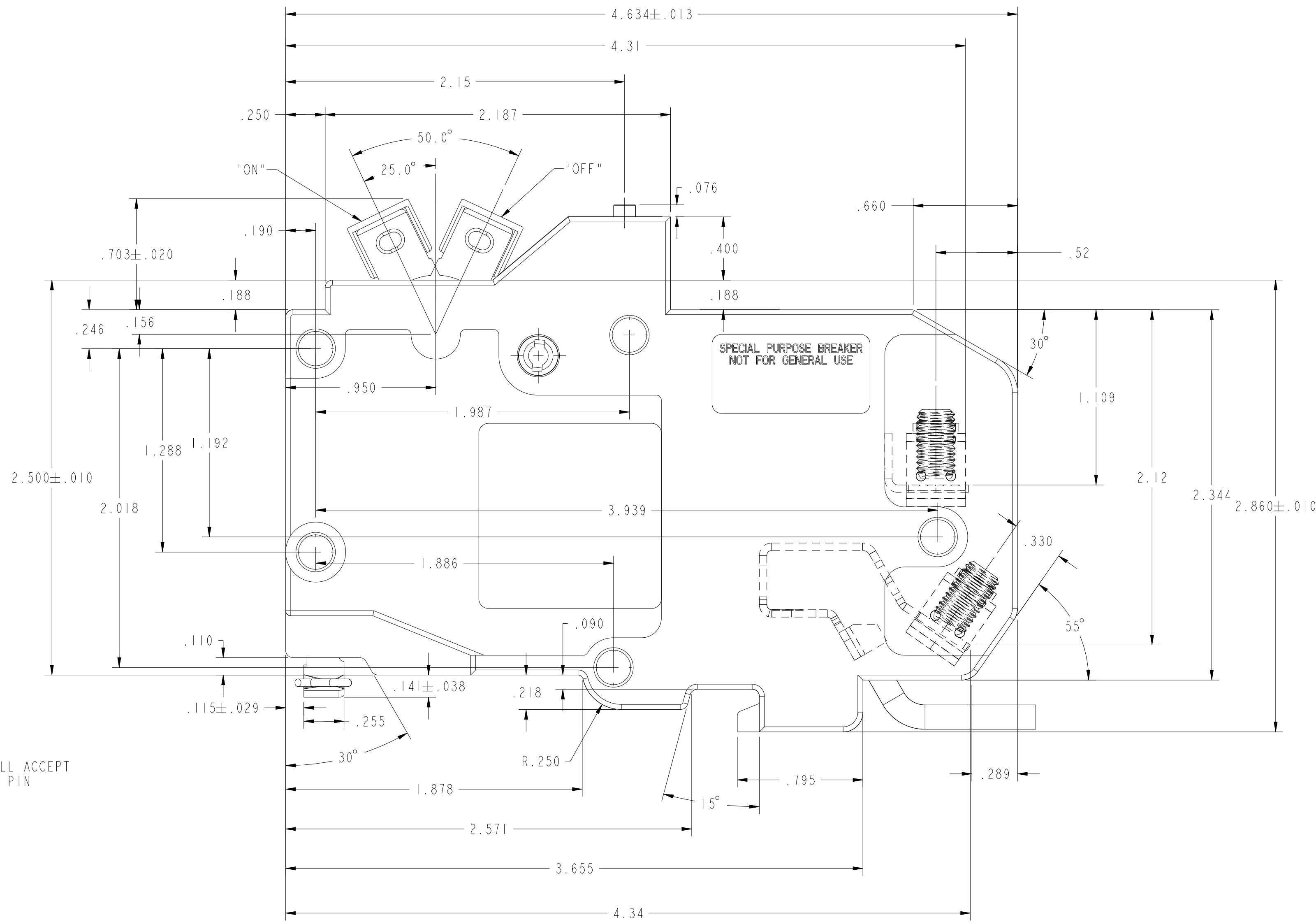

UNLESS OTHERWISE SPECIFIED DIMENSIONS IN INCHES X.X ±0.1 X.XX ±0.01 X.XXX ±0.001 " ±0 X.X" ±0.5	DRAWING IN ACCORDANCE WITH ASME Y14.3M-1994	CLXXXII SYMBOLS PER 483-1143	ENG'G REFERENCE PRODUCT CODE: BCD9	DRAWER/DRAWING L. PORTUONDO	DATE (YYYYMMDD) 2015/07/02	MANUFACTURING M. GONZALEZ	ECO # ECO-082761	EATON CORPORATION - CONFIDENTIAL AND PROPRIETARY NOTICE TO PERSONS RECEIVING THIS DOCUMENT AND/OR TECHNICAL INFORMATION THIS DOCUMENT, INCLUDING THE DRAWING AND INFORMATION CONTAINED THEREON, IS CONFIDENTIAL AND IS THE EXCLUSIVE PROPERTY OF EATON CORPORATION, AND IS LOANED TO YOU AND SUBJECT TO RECEIPT BY EATON AT ANY TIME. BY TAKING POSSESSION OF THIS DOCUMENT, THE RECIPIENT ACKNOWLEDGES AND AGREES THAT THE DOCUMENT CANNOT BE COPIED OR OTHERWISE DISSEMINATED WITHOUT THE PRIOR WRITTEN CONSENT OF EATON. IN THE CASE OF CONFLICTING CONTRACTUAL PROVISIONS, THIS NOTICE SHALL GOVERN THE STATUS OF THIS DOCUMENT. © 2015 Eaton Corporation. All Rights Reserved.
	TITLE GROUND FAULT CIRCUIT INTERRUPTER 3/4" 2-POLE GFT 15A - 60A OUTLINE DRAWING				DRAWING NUMBER 96-6970		REVISION 001	
CHANGE RESPONSIBILITY RWDD_MCB_ENG'NEERING				SCALE 2.000 = 1.000		SHEET 1 OF 1		

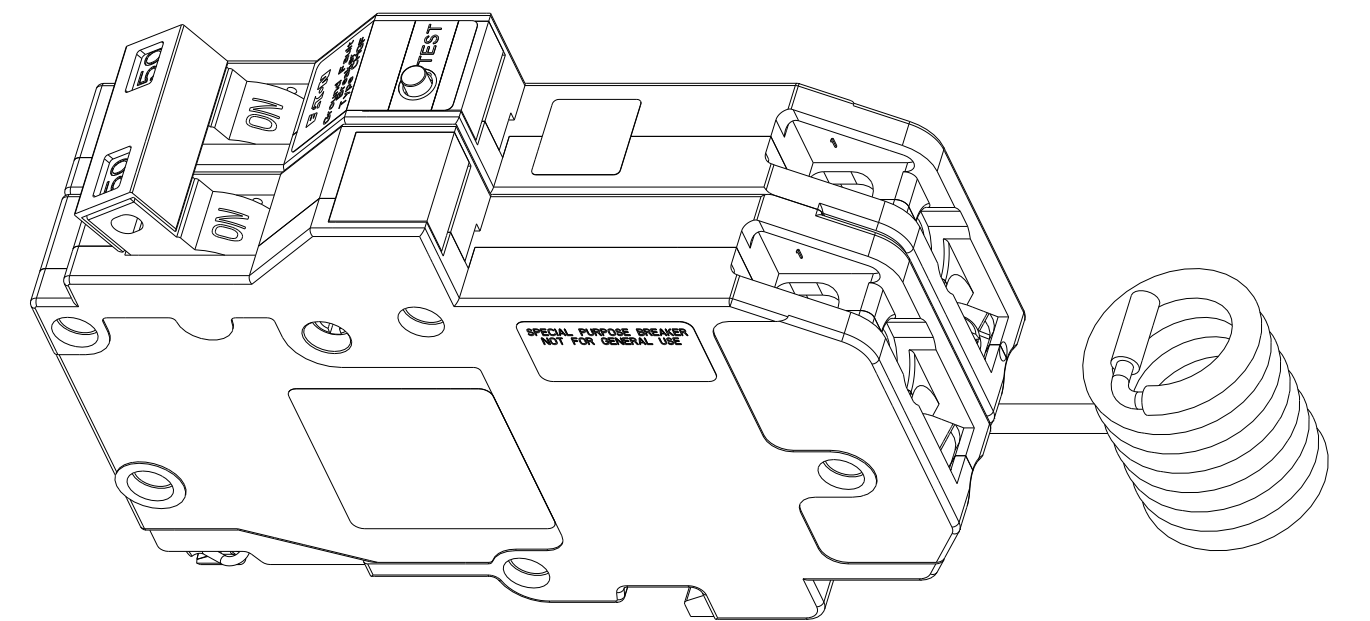
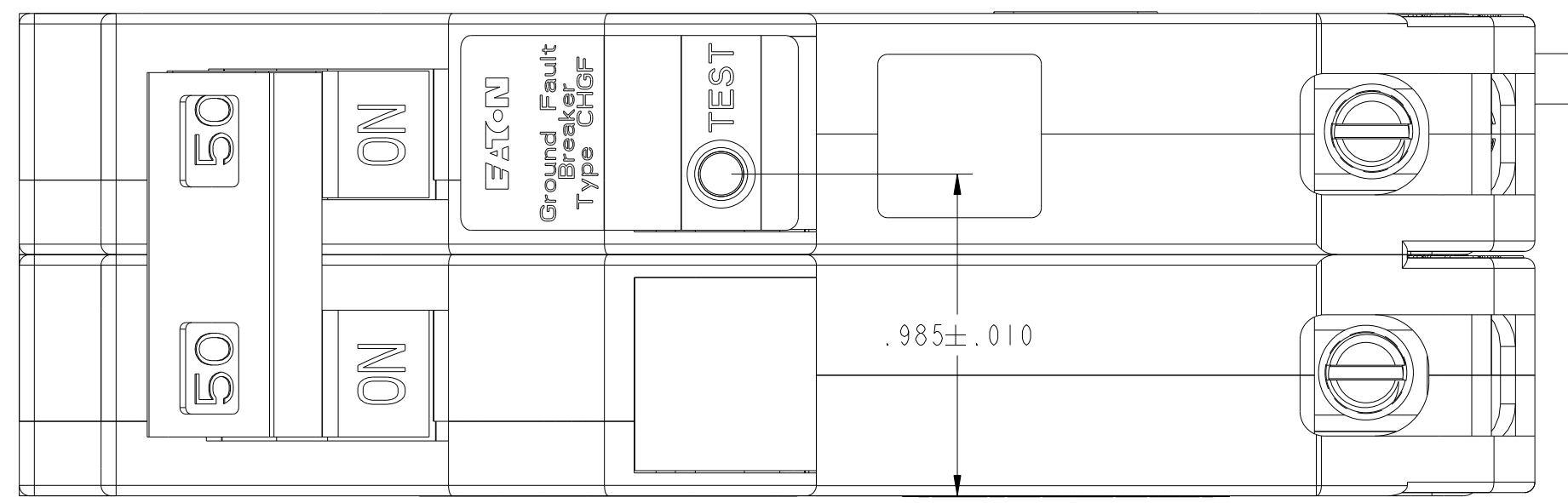

SCALE 1.000

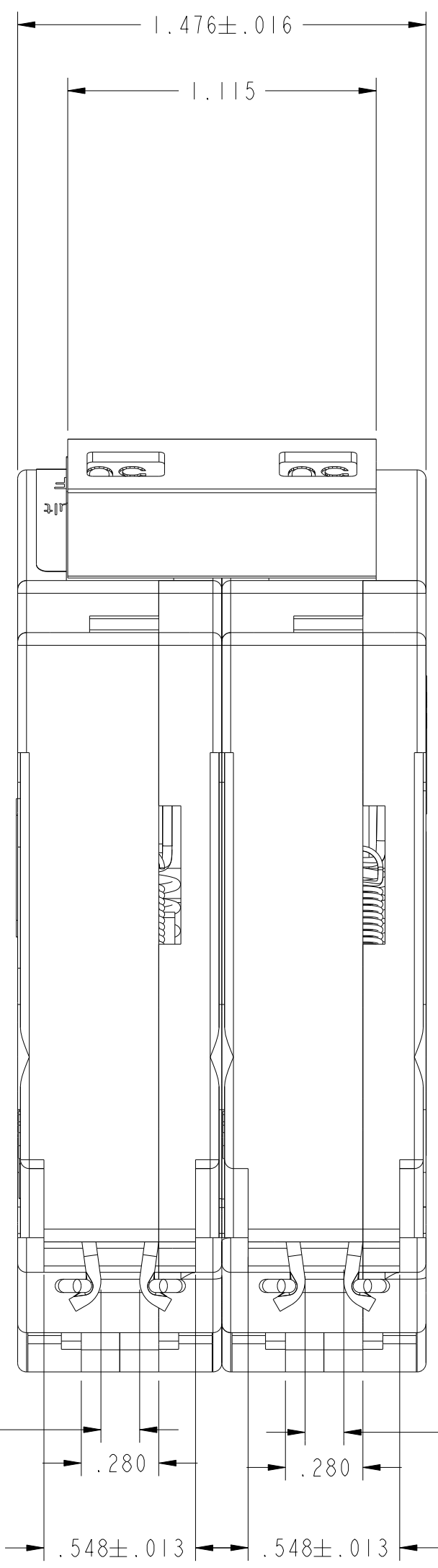

OPENING WILL ACCEPT A 3/16 DIA PIN

OPENING WILL ACCEPT A 3/16 DIA PIN

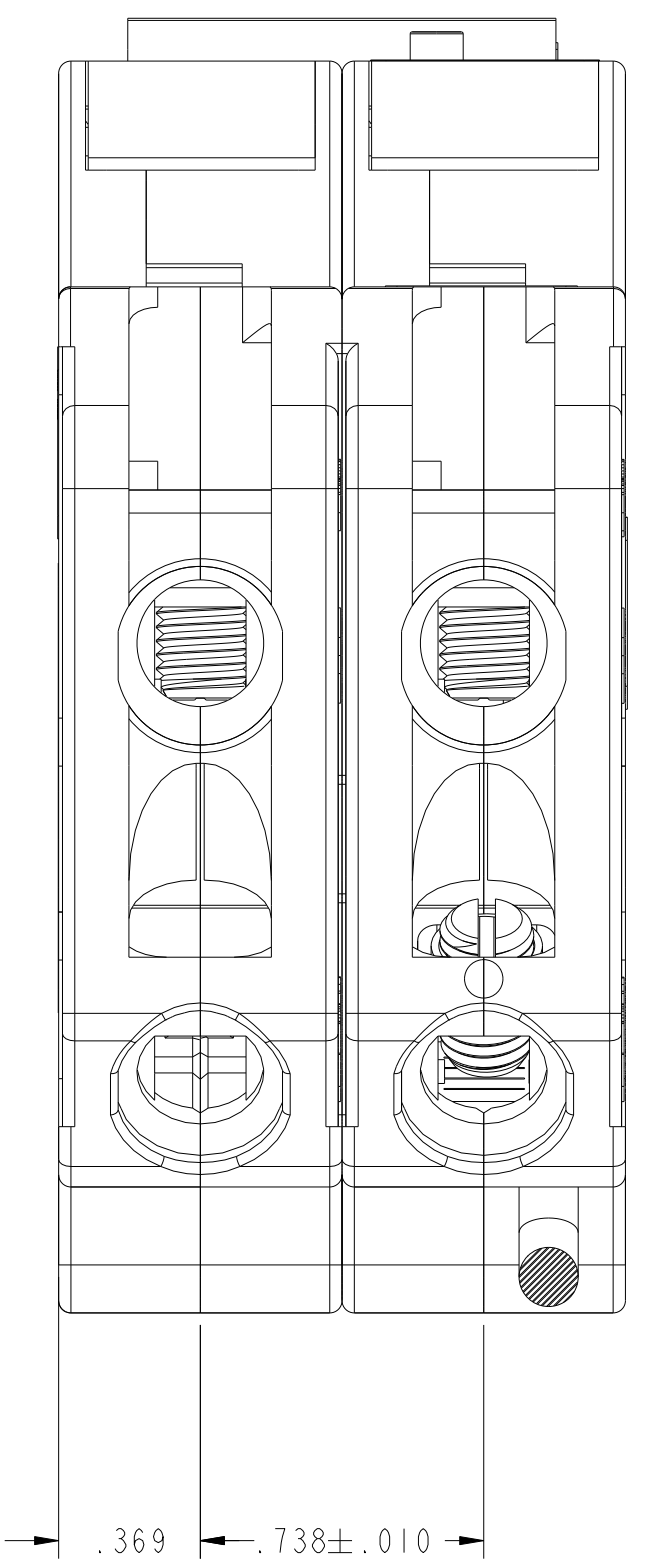
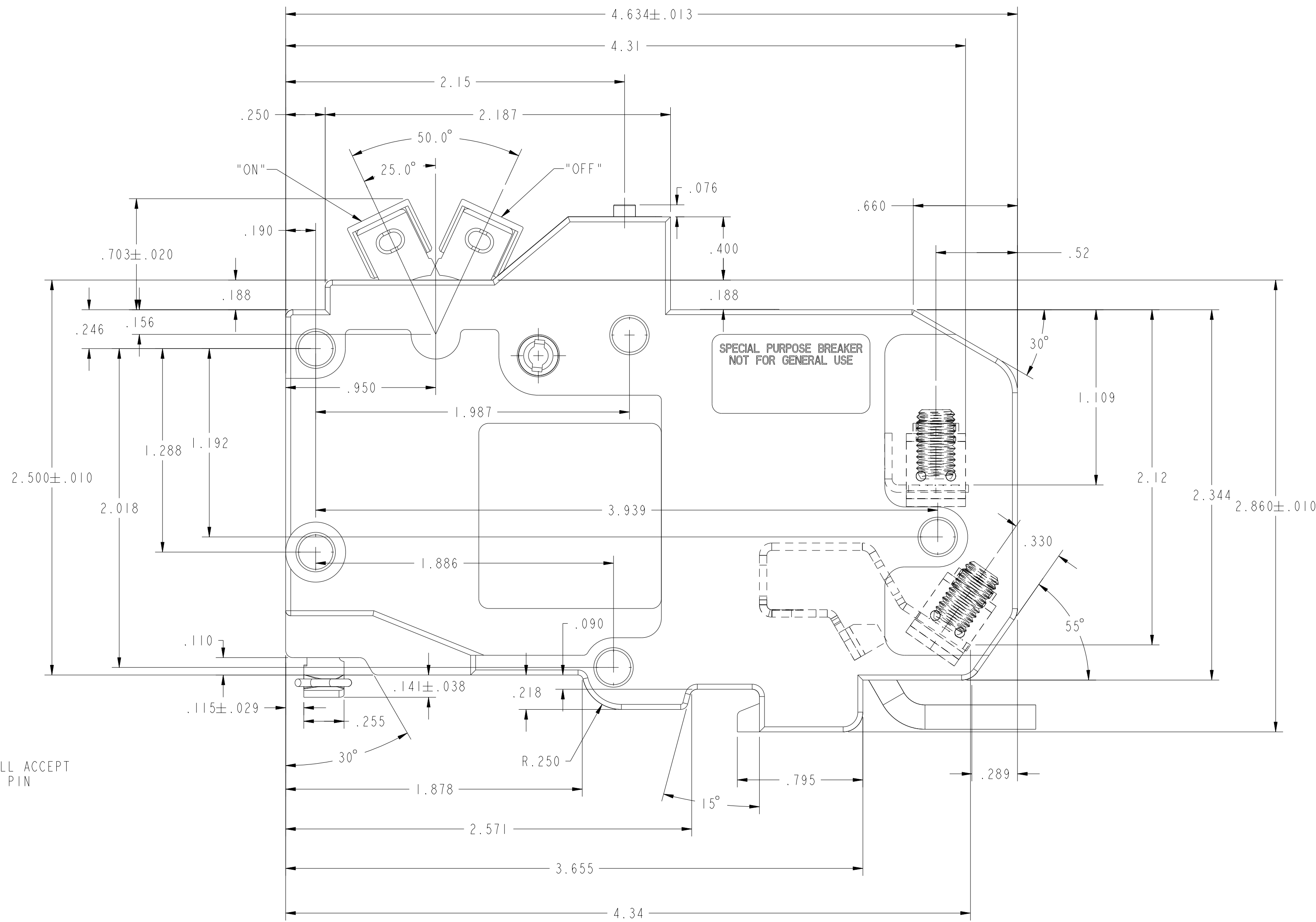

UNLESS OTHERWISE SPECIFIED DIMENSIONS IN INCHES X.X ±0.1 X.XX ±0.01 X.XXX ±0.001 " ±0 X.X" ±0.5	DRAWING IN ACCORDANCE WITH ASME Y14.5M-1994	ENGINEERING APPROVED G. DE JESUS	MANUFACTURING M. GONZALEZ	DATE (YYYYMMDD) 2015/07/02	EATON CORPORATION - CONFIDENTIAL AND PROPRIETARY NOTICE TO PERSONS RECEIVING THIS DOCUMENT AND/OR TECHNICAL INFORMATION THIS DOCUMENT, INCLUDING THE DRAWING AND INFORMATION CONTAINED THEREON, IS CONFIDENTIAL AND IS THE EXCLUSIVE PROPERTY OF EATON CORPORATION, AND IS LOANED TO YOU AND SUBJECT TO RECEIPT BY EATON AT ANY TIME. BY TAKING POSSESSION OF THIS DOCUMENT, THE RECIPIENT ACKNOWLEDGES AND AGREES THAT THIS DOCUMENT MAY BE COPIED OR OTHERWISE DISCLOSED WITHOUT THE PRIOR WRITTEN CONSENT OF EATON. IN THE CASE OF CONFLICTING CONTRACTUAL PROVISIONS, THIS NOTICE SHALL GOVERN THE STATUS OF THIS DOCUMENT. © 2015 Eaton Corporation. All Rights Reserved.
	REVISION DESCRIPTION NEW DRAWING	ECO # ECO-082761	REVISION 001	TITLE GROUND FAULT CIRCUIT INTERRUPTER 3/4" 2-POLE GFT 15A - 60A OUTLINE DRAWING	CLASS CODE NA
CHANGE RESPONSIBILITY RWDD_MCB_ENGINEERING	SCALE 2.000	SHEET 1 OF 1	DSD-019-FMT REV 1		