

# PowerMate™ drilling pin and sleeve connectors



Powering Business Worldwide





# Safe. Reliable. Fast. Connections

The ideal rig power connection solution

- Longer product life
- Enhanced safety
- Reduced maintenance
- Easy to install

# PowerMate™ Series

Drilling rig pin and sleeve power connections



PowerMate™ is designed to support the modularity of drilling rig systems by providing safe and reliable power connections for rigging-up and rigging-down equipment quickly and efficiently.

#### The ideal rig power connection solution

- Longer product life
- Reduced maintenance
- Enhanced safety
- Easy-to-install

#### Compatible with all UL1686 Listed plugs and receptacles

- Eaton's Crouse-Hinds Arkтите®
- Appleton Powertite®
- Killark VersaMate®

#### Application

- On SCR/VFD houses to provide power to rig equipment such as shakers, agitators, lighting circuits, mud pumps, motors, etc.
- Quickly and efficiently connect power during rig-ups and disconnect power during rig-downs

#### EXCLUSIVE FEATURES

- Lockout plug
- Fixed safety insulator
- Diamond cable clamp
- Split pin contacts
- Suited for use with Type P cable



# Specifications & features

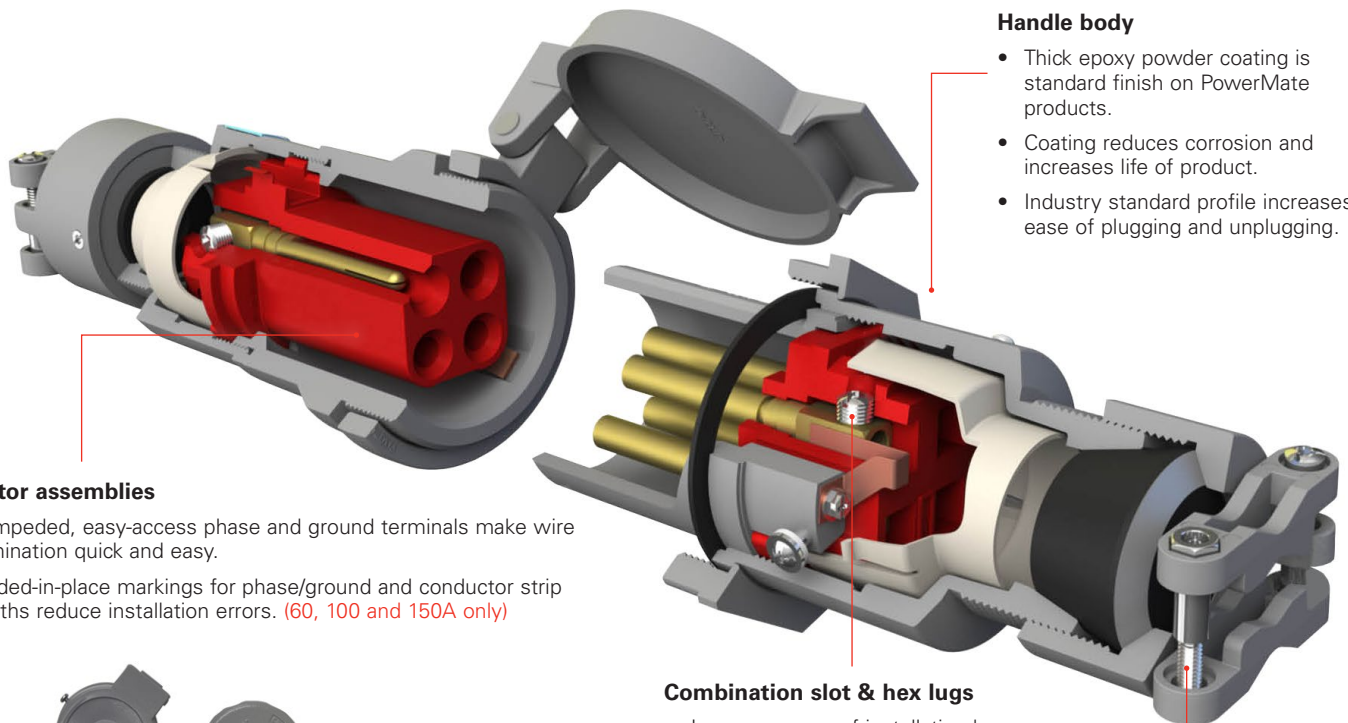

## Handle body

- Thick epoxy powder coating is standard finish on PowerMate products.
- Coating reduces corrosion and increases life of product.
- Industry standard profile increases ease of plugging and unplugging.

## Insulator assemblies

- Unimpeded, easy-access phase and ground terminals make wire termination quick and easy.
- Molded-in-place markings for phase/ground and conductor strip lengths reduce installation errors. (60, 100 and 150A only)



## Spring and threaded cover options

- Each 30, 60, 100 and 150A receptacle comes with both spring cap and threaded cap to provide a variety of cover options.
- 200A comes with spring cap and wing nuts to ensure environmental sealing.

## Combination slot & hex lugs

- Increases ease of installation by allowing for more than one option for installation tools.
- Hex head allows for easy achievement of specified torque value.

## Combination drive stainless steel hardware

- Increases ease of installation by allowing for more than one option for installation tools.
- Stainless steel external hardware eliminates corrosion on critical components and extends product life.



## Extended cable range

- Industry's largest cable diameter range.
- Specifically designed, third party tested and certified for use with Type P cable.
- Sealing system utilizes industry standard bushings.



## Enhanced nomenclature and nameplate

- Easily understandable nomenclature increases ease of part configuration identification.
- Mechanically attached nameplate ensures that critical information is permanently fixed to product.

## Exclusive features



### 8-point diamond cable clamps

- 8 points of contact around diameter of cable for increased grip and even distribution of pressure.
- Cable jacket does not get pinched, eliminating potential for damage to internal conductors.



### Lockout plug

- Guarantees isolated power supply with OSHA compliant lockout/tagout.
- Ensures plug cannot be inserted into receptacle when maintenance is being performed downstream of power supply.



### Split pin contact design

- Provides nearly 360° of contact at every insertion, ensuring protection against heat rise and eliminating arcing on critical surfaces.
- Self-wiping at every insertion to remove foreign particles that create electrical resistance and product failure.



### Fixed safety insulator

- Prevents electrical shock and shorts with plastic barrier between insulator body and metal housing.
- Fixed-in-place design ensures insulator will not be lost or discarded during cable termination process. (30, 60, 100 and 150A only)

### Electrical ratings

- 30, 60, 100, 150, 200A 600 VAC/250 VDC

### Certifications and compliances

- Plugs (CCP 30-150A, including CCP3034) hazardous location rated when used with Crouse-Hinds interlocked receptacles (ex. FSQC, EBBR models)
  - Class I, Division 1, Groups B, C, D (excludes 200A)
  - Class II, Division 1, Groups F, G (excludes 200A)
- CE marked (excludes RS option and 200A)
- UL standards
  - UL1682; UL1686; NEMA250; IEC60309-1; IEC60309-2
- CSA standard
  - CSA 22.2 No. 182.1
- Suited for use with Type P cable, flexible cord and cables rated for extra hard usage
- NEMA 4X



### Options

- **Special polarity** – receptacle interior rotated 22.5° to the right and plug changed to match. For use where two or more receptacles of the same ampere rating, style and number of poles are to be installed in the same area for use on different voltages and/or frequencies. Prevents insertion of a plug in a receptacle with different electrical rating.
- **Reverse service** – receptacle assembled with plug interior and plug assembled with receptacle interior. Used in applications where plug is energized to feed normally de-energized receptacle. Interiors are field interchangeable using only a screwdriver.
  - (\* excludes 150 and 200A)

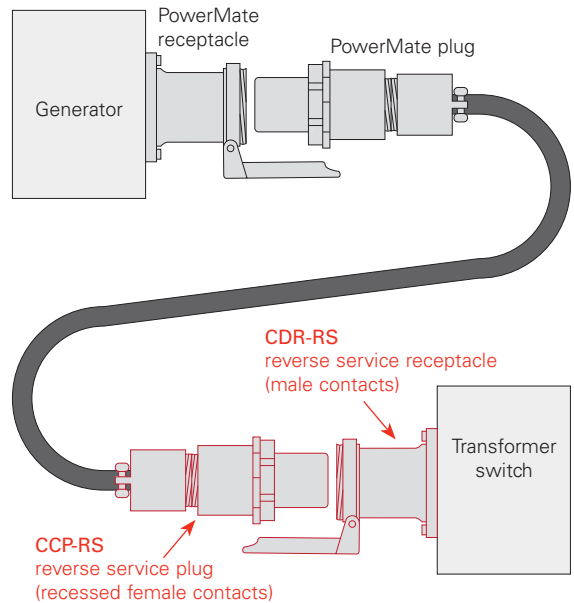

### Standard materials

- Receptacle housing, plug and cord connector bodies - high impact strength copper-free aluminum (less than 0.4% copper)
- Back boxes - cast aluminum
- Insulation - fiberglass reinforced polyester
- Contacts - naval brass

### Standard finishes

- Copper-free aluminum - epoxy powder coat
- Fiberglass reinforced polyester - natural (red)
- Naval brass - natural

## Additional features - 200 Amp

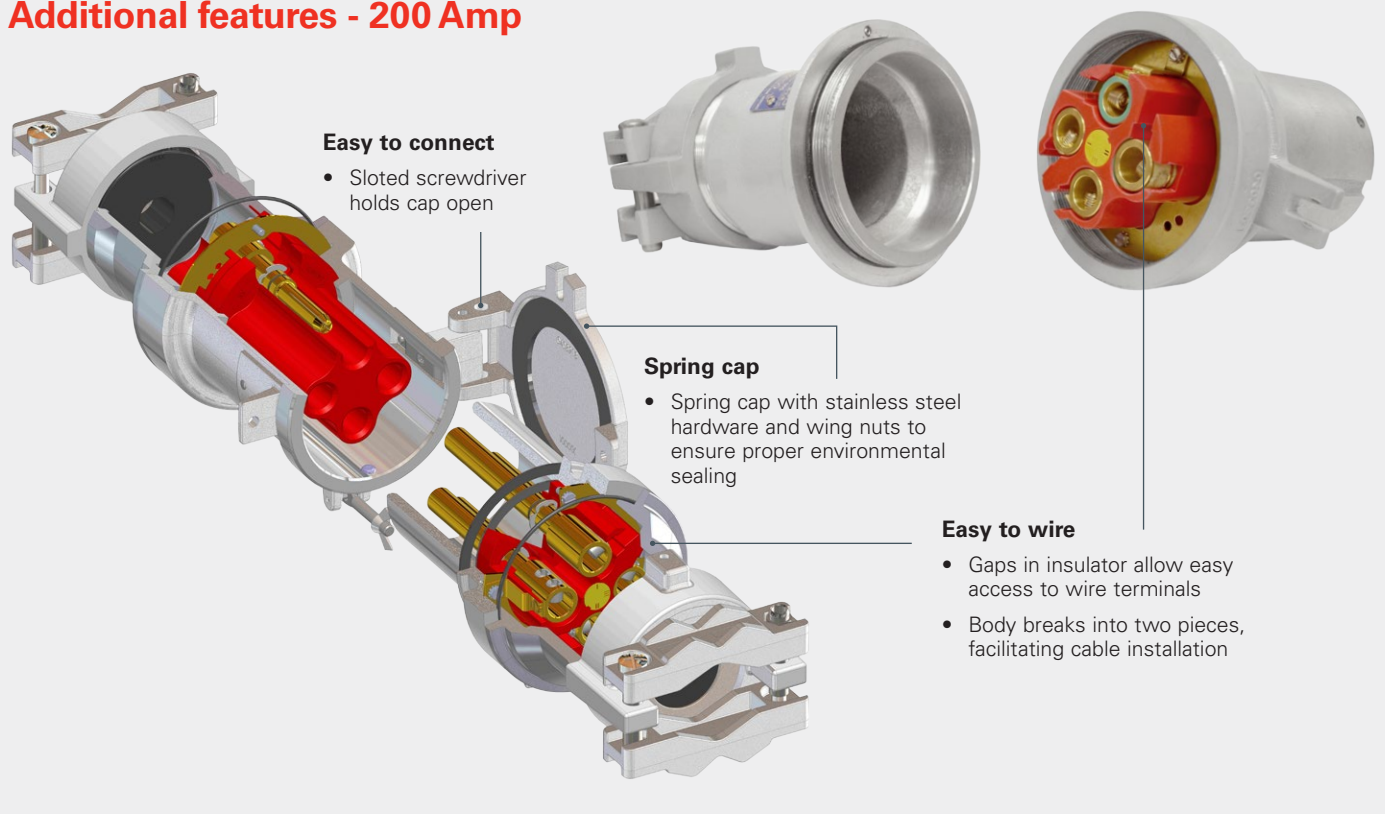

# Ordering information

Part number example and description

## CCP3034BC-RS

Eaton's Crouse-Hinds PowerMate™ plug, 30A, 3 wire, 4 pole, 0.390-1.375" cable range, reverse service

CCP
30
3
4
BC
-
RS

**Product type**

CCP	Plug
CDR	Receptacle
CRC	Connector
CDRE*	Receptacle with CEE back box
CDJA**	Receptacle with CJA back box

\* Available with 30A and 60A receptacle  
\*\* Available with 60A, 100A, 150A and 200A receptacle

**Wire**

2*	2 wire
3	3 wire
4	4 wire

\* Available with 30A, 60A and 100A product

**Pole**

2	2 pole
3	3 pole
4	4 pole

**Options**

-RS	Reverse service
-P4	Special polarity

**Amperage**

30	30 Amp
60	60 Amp
100	100 Amp
150	150 Amp
200	200 Amp

**Hub size (receptacle with back box only)\***

50	½"
75	¾"
100	1"
125	1-¼"
150	1-½"
200	2"
250	2-½"
300	3"
350	3-½"
400	4"
500	5"

**Cable range (plug & connector only)\***

BC	0.390 to 1.375"
CD	0.875 to 1.906"
DE	1.250 to 2.190"
E	1.875 to 2.500"
F	2.500 to 3.000"
G	3.000 to 3.500"

\* Cable range only applies to specific plug part numbers      \* Hub size only applies to specific receptacle part numbers

## Horsepower ratings

Amp rating	Voltage
30, 60, 100, 150, 200	600 VAC, 50 to 400Hz 250 VDC*

\* This guide is for reference only. Consult your local electrical codes before installation.

## Maximum horsepower for plug and receptacle combinations by input voltage

Typical horsepower ratings based on NEC Article 430 tables. HP ratings are based on the largest conductor size for each plug and receptacle combination.

Amp rating	Motor horsepower**		
	240V	480V	600V
30	15	30	40
60	20	40	50
100	30	60	75
150	40	75	100
200	60	125	150

\*\* Eaton's Crouse-Hinds recommends circuit breaking use be limited to emergency conditions only and that a horsepower rated switch or Crouse-Hinds interlocked receptacle be used for making and breaking under load.

## Grounding

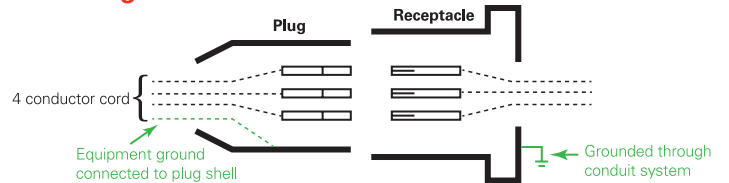

Style 1 units complete the grounding circuit through the metallic plug shell, receptacle housing or connector shell

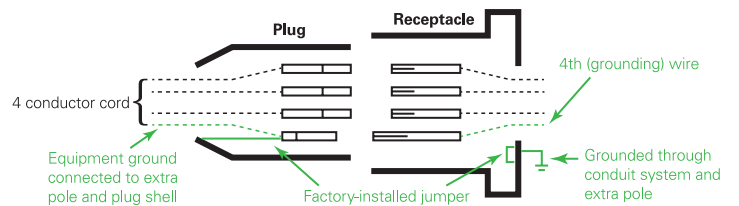

Style 2 units with metal housing have a separate designated ground contact that is bonded to the metallic housing. The metallic housing of the plug, receptacle or connector forms a parallel ground circuit through the receptacle or connector detent spring.

## Wire sizes





The wire size table lists the diameter of the wire recess in PowerMate plug and receptacle contacts so that maximum size of bare conductor can be determined. Range of wire sizes shown in table are intended only as a guide. Depending on type of wire used (building wire, flexible or extra flexible cable) and its construction (number and size of strands), bare copper diameters vary widely.

### Diameter: wire recess in plug & receptacle contacts

Amperage rating	Contact type	Diameter of recess	Wire size* extra flex
<b>30 (2, 3 &amp; 4 pole)</b>	Pressure	0.281"	#10 to #8
<b>60 (2, 3 &amp; 4 pole)</b>	Pressure	0.312"	#8 to #4
<b>100 (2, 3 &amp; 4 pole)</b>	Pressure	0.390"	#4 to #2
<b>150 (4 pole)</b>	Pressure	0.390"	#2 to 1/0
<b>200 (3 &amp; 4 pole)</b>	Pressure	0.687"	2/0 to 250 MCM

\* Do not use wire size smaller than minimum size recommended

## 30 Amp: Receptacles, plugs, connectors





Description & configuration	Receptacle	Plug		Cord connector		
		Cable range	Part number	Cable range	Part number	
2 wire 2 pole style 1		<b>CDR3022</b>	0.390-1.375"	<b>CCP3022BC</b>	0.390-1.375"	<b>CRC3022BC</b>
2 wire 3 pole style 2		<b>CDR3023</b>	0.390-1.375"	<b>CCP3023BC</b>	0.390-1.375"	<b>CRC3023BC</b>
3 wire 3 pole style 1		<b>CDR3033</b>	0.390-1.375"	<b>CCP3033BC</b>	0.390-1.375"	<b>CRC3033BC</b>
3 wire 4 pole style 2		<b>CDR3034</b>	0.390-1.375"	<b>CCP3034BC</b>	0.390-1.375"	<b>CRC3034BC</b>
4 wire 4 pole style 1		<b>CDR3044</b>	0.390-1.375"	<b>CCP3044BC</b>	0.390-1.375"	<b>CRC3044BC</b>

## Back boxes

Hub size	CEE	CERH	CERC
½"	<b>CEE13</b>	<b>CERH13</b>	<b>CERC13</b>
1-¼"	<b>CEE23</b>	<b>CERH23</b>	<b>CERC23</b>
1-½"	<b>CEE33</b>	<b>CERH33</b>	<b>CERC33</b>

- Standard Corro-Free™ epoxy powder coat finish for increased corrosion resistance
- For optional reversed interior, use suffix **-RS**
- For optional rotated interior, use suffix **-P4**
- Maximum conductor size (wire well) 0.281"

## 60 Amp: Receptacles, plugs, connectors





Description & configuration	Receptacle	Plug		Cord connector		
		Cable range	Part number	Cable range	Part number	
2 wire 2 pole style 1		<b>CDR6022</b>	0.440-1.375"	<b>CCP6022BC</b>	0.440-1.375"	<b>CRC6022BC</b>
2 wire 3 pole style 2		<b>CDR6023</b>	0.440-1.375"	<b>CCP6023BC</b>	0.440-1.375"	<b>CRC6023BC</b>
3 wire 3 pole style 1		<b>CDR6033</b>	0.440-1.375"	<b>CCP6033BC</b>	0.440-1.375"	<b>CRC6033BC</b>
3 wire, 4 pole style 2		<b>CDR6034</b>	0.440-1.375"	<b>CCP6034BC</b>	0.440-1.375"	<b>CRC6034BC</b>
4 wire 4 pole style 1		<b>CDR6044</b>	0.440-1.375"	<b>CCP6044BC</b>	0.440-1.375"	<b>CRC6044BC</b>

## Back boxes

Hub size	CEE	CERH	CJA	CERC
½"	<b>CEE36</b>	<b>CERH36</b>	<b>CJA310</b>	<b>CERC36</b>
1-¼"	<b>CEE46</b>	<b>CERH46</b>	<b>CJA410</b>	<b>CERC46</b>
1-½"	<b>CEE56</b>	<b>CERH56</b>	<b>CJA510</b>	<b>CERC56</b>
2"	-	-	<b>CJA610</b>	-

- Standard Corro-Free™ epoxy powder coat finish for increased corrosion resistance
- For optional reversed interior, use suffix **-RS**
- For optional rotated interior, use suffix **-P4**
- Maximum conductor size (wire well) 0.312"

## 100 Amp: Receptacles, plugs, connectors



Description & configuration	Receptacle	Plug		Cord connector	
		Cable range	Part number	Cable range	Part number
2 wire 2 pole style 1	 <b>CDR1022</b>	0.875-1.906"	<b>CCP1022CD</b>	0.875-1.906"	<b>CRC1022CD</b>
2 wire 3 pole style 2	 <b>CDR1023</b>	0.875-1.906"	<b>CCP1023CD</b>	0.875-1.906"	<b>CRC1023CD</b>
3 wire 3 pole style 1	 <b>CDR1033</b>	0.875-1.906"	<b>CCP1033CD</b>	0.875-1.906"	<b>CRC1033CD</b>
3 wire 4 pole style 2	 <b>CDR1034</b>	0.875-1.906"	<b>CCP1034CD</b>	0.875-1.906"	<b>CRC1034CD</b>
4 wire 4 pole style 1	 <b>CDR1044</b>	0.875-1.906"	<b>CCP1044CD</b>	0.875-1.906"	<b>CRC1044CD</b>

## Back boxes: 100 & 150 Amp





Hub size	CJA	CJA adapter only
1"	<b>CJA310</b>	
1-¼"	<b>CJA410</b>	
1-½"	<b>CJA510</b>	<b>CJA100</b>
2"	<b>CJA610</b>	

- Standard Corro-Free™ epoxy powder coat finish for increased corrosion resistance
- For optional reversed interior, use suffix **-RS**
- For optional rotated interior, use suffix **-P4**
- Maximum conductor size (wire well) 0.390"

## 150 Amp: Receptacles, plugs, connectors

Description & configuration	Receptacle	Plug		Cord connector	
		Cable range	Part number	Cable range	Part number
3 wire 4 pole style 2	 <b>CDR15034</b>	0.875-1.906"	<b>CCP15034CD</b>	0.875-1.906"	<b>CRC15034CD</b>
		1.250-2.190"	<b>CCP15034DE</b>	1.250-2.190"	<b>CRC15034DE</b>
4 wire 4 pole style 1	 <b>CDR15044</b>	0.875-1.906"	<b>CCP15044CD</b>	0.875-1.906"	<b>CRC15044CD</b>
		1.250-2.190"	<b>CCP15044DE</b>	1.250-2.190"	<b>CRC15044DE</b>

## 200 Amp: Receptacles, plugs, connectors

Description & configuration	Receptacle	Plug		Cord connector	
		Cable range	Part number	Cable range	Part number
2 wire, 3 pole style 2	 <b>CDR20023</b>	0.875-1.906"	<b>CCP20023CD</b>	0.875-1.906"	<b>CRC20023CD</b>
		1.875-2.500"	<b>CCP20023E</b>	1.875-2.500"	<b>CRC20023E</b>
3 wire, 3 pole style 1	 <b>CDR20033</b>	0.875-1.906"	<b>CCP20033CD</b>	0.875-1.906"	<b>CRC20033CD</b>
		1.875-2.500"	<b>CCP20033E</b>	1.875-2.500"	<b>CRC20033E</b>
3 wire 4 pole style 2	 <b>CDR20034</b>	0.875-1.906"	<b>CCP20034CD</b>	0.875-1.906"	<b>CRC20034CD</b>
		1.875-2.500"	<b>CCP20043E</b>	1.875-2.500"	<b>CRC20034E</b>
4 wire 4 pole style 1	 <b>CDR20044</b>	0.875-1.906"	<b>CCP20044CD</b>	0.875-1.906"	<b>CRC20044CD</b>
		1.875-2.500"	<b>CCP20044E</b>	1.875-2.500"	<b>CRC20044E</b>

## Back boxes

Hub size	CJA	CJAC (through-feed)	CJA adapter only
1-½"	<b>CJA520</b>	-	
2"	<b>CJA620</b>	-	<b>CJA200</b>
2-½"	<b>CJA720</b>	<b>CJAC720</b>	

- Standard Corro-Free™ epoxy powder coat finish for increased corrosion resistance
- For optional reversed interior, use suffix **-RS**
- For optional rotated interior, use suffix **-P4**
- Maximum conductor size (wire well) 0.281"



## Dimensions

### Receptacle

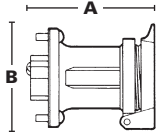

### Plug

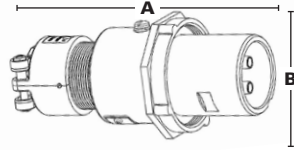

### Connector

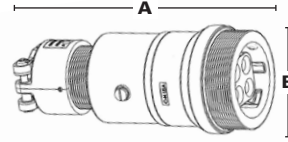

Receptacle	A	B
30A	2.8750	3.3750
60A, 3 pole	4.2500	4.5000
60A, 4 pole	4.2500	4.5000
100A, 3 pole	5.2500	4.2500
100A, 4 pole	5.2500	4.2500
150A CD	5.2500	4.2500
150A DE	5.2500	4.2500
200A	7.8750	7.1875

Plug	A	B
30A	6.5000	2.3125
60A, 3 pole	8.1700	3.6250
60A, 4 pole	8.1700	3.7500
100A, 3 pole	10.8000	3.7500
100A, 4 pole	10.8000	4.1250
150A CD	10.8000	4.1250
150A DE	10.8000	4.1250
200A	13.1250	7.5000

Connector	A	B
30A	6.6000	2.5625
60A, 3 pole	8.3000	2.3125
60A, 4 pole	8.3000	2.3125
100A, 3 pole	11.5000	3.1875
100A, 4 pole	11.5000	3.4375
150A CD	11.5000	3.4375
150A DE	11.5000	3.4375
200A	14.0000	8.2000

### Back boxes: 30 & 60A only

Part number	Rating	Hub Size	A	B
CEE13	30A	½"	1.8440	0.6875
CEE23	30A	¾"	1.8440	0.8125
CEE33	30A	1"	1.9690	0.9375
CEE36	60A	1"	2.5625	0.9375
CEE46	60A	1-¼"	2.6250	1.1875
CEE56	60A	1-½"	2.6875	1.3125

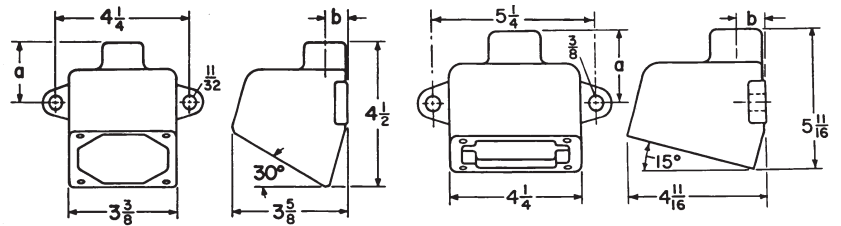

### Back boxes with 60, 100, 150 & 200A angle adapters

Part number	Rating	Hub Size	A	B	C	D	E	F
CJA310	60, 100, 150A	1"	5.8750	8.0000	7.4375	4.8750	7.0000	15°
CJA410	60, 100, 150A	1-¼"	5.8750	8.0000	7.4375	4.8750	7.0000	15°
CJA510	60, 100, 150A	1-½"	5.8750	8.0000	7.4375	4.8750	7.0000	15°
CJA610	60, 100, 150A	2"	5.8750	8.0000	8.0000	4.8750	7.0000	15°
CJA520	200A	1-½"	8.0000	10.7500	9.8750	6.7500	9.5000	45°
CJA620	200A	2"	8.0000	10.7500	9.8750	6.7500	9.5000	45°
CJA720	200A	2-½"	8.0000	10.7500	9.8750	6.7500	9.5000	45°
CJAC720	200A	2-½"	8.0000	10.7500	9.8750	6.7500	9.5000	45°

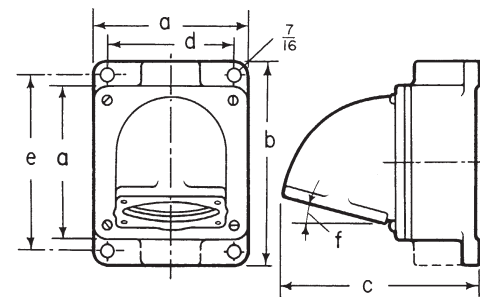

- Back boxes are standard with Corro-Free™ epoxy powder coat finish for increased corrosion resistance
- Through feed back boxes are furnished with one close-up plug in bottom recessed hub
- CJA back boxes are recommended when additional wiring space is required
- The angle adapter on CJA back boxes can be installed at 90° rotations, making it possible to enter hub from several directions

## Replacement parts

### Standard replacement parts

Complete insulator assembly		30A	60A	100A	150A	200A
2W2P	CDR-CRC	CRI-3022	CRI-6022	CRI-1022	–	–
	CCP	CPI-3022	CPI-6022	CPI-1022	–	–
2W3P	CDR-CRC	CRI-3023	CRI-6023	CRI-1023	–	CRI-20023
	CCP	CPI-3023	CPI-6023	CPI-1023	–	CPI-20023
3W3P	CDR-CRC	CRI-3033	CRI-6033	CRI-1033	–	CRI-20033
	CCP	CPI-3033	CPI-6033	CPI-1033	–	CPI-20033
3W4P	CDR-CRC	CRI-3034	CRI-6034	CRI-1034	CRI-15034	CRI-20034
	CCP	CPI-3034	CPI-6034	CPI-1034	CPI-15034	CPI-20034
4W4P	CDR-CRC	CRI-3044	CRI-6044	CRI-1044	CRI-15044	CRI-20044
	CCP	CPI-3044	CPI-6044	CPI-1044	CPI-15044	CPI-20044

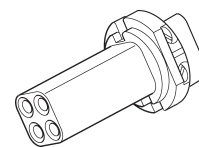

CRI receptacle & connector interior

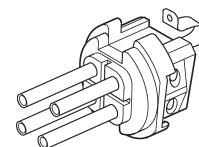

CPI plug interior

### Miscellaneous replacement parts

Amperage	Configuration	CDR spring cover	CDR threaded cover	CCP fastening ring	Bushing kits
30	2, 3 & 4 pole	PTSC30	PTTC30	CLMPR30	PTGB30
60	2, 3 & 4 pole	PTSC60A	PTTC60A	CLMPR23P60	PTGB60
		PTSC60B	PTTC60B	CLMPR4P60	
100	2, 3 & 4 pole	PTSC100A	PTTC100A	CLMPR23P100	PTGBCD
		PTSC100B	PTTC100B	CLMPR4P100	
150	4 pole	PTSC150B	PTTC150B	CLMPR4P150	PTGBCD (CD size)
					PTGBDE (DE size)



Spring cover



Threaded cover



Bushing kit

Amperage	Configuration	CDR spring cover	Brass retaining ring	Plug contact	Plug ground contact	Receptacle contact	Receptacle ground contact	Bushing kit
200A	3 pole	PTLC200	PTBR2003	PTPC200	PTPC200G	PTRC200	PTRC200G	PTGB200CD (CD size)
	4 pole		PTBR2004					PTGB200E (E size)

- 1 Derrick/Mast
- 2 VFD/Generators
- 3 Fuel Tank
- 4 Motor Control/VFD/SCR House
- 5 Doghouse/ Operator's House
- 6 Power/Pump Station
- 7 Shale Shaker
- 8 Mud Tanks/Pumps
- 9 Drawworks & Top Drive
- 10 Drilling Floor

# Full portfolio of land-based powering solutions

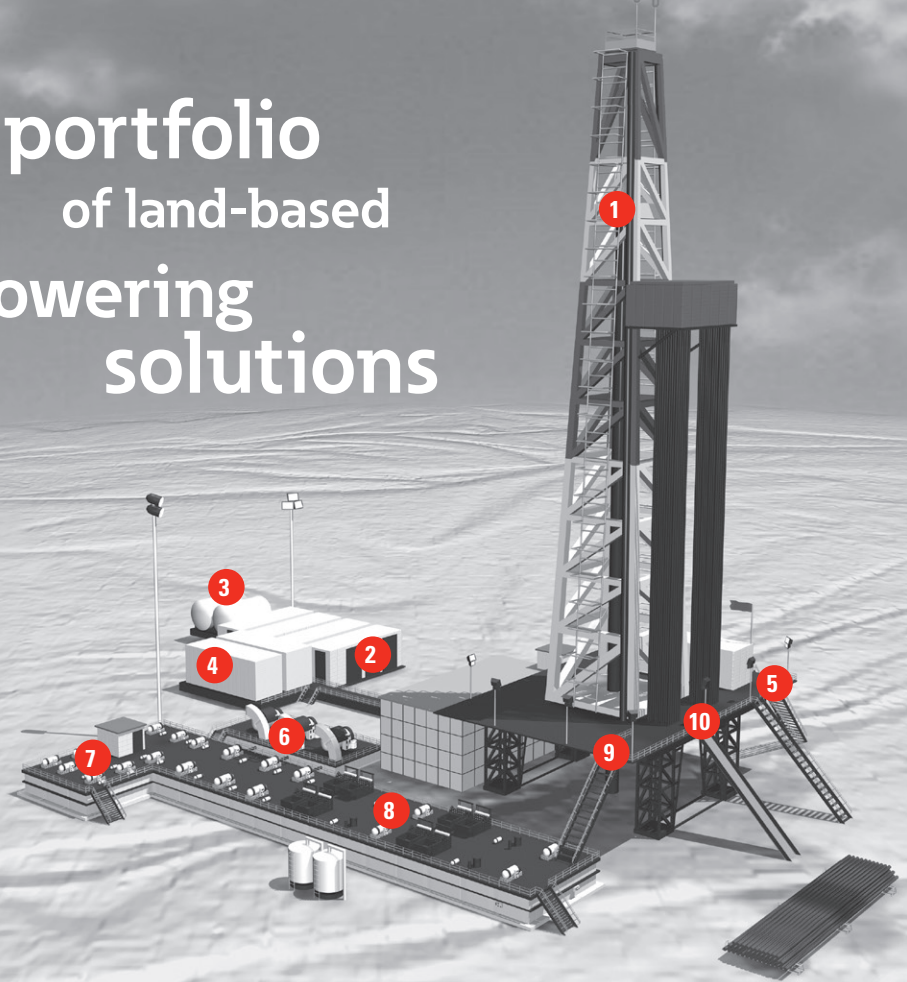

## Crouse-Hinds drilling solutions

### Single pole power

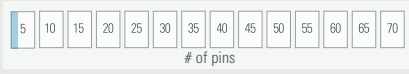

#### Roughneck™ Single Pole Series



Secure, single pole power, rated to 1135A for use in hazardous and normal locations. Ideal for delivering power to the top drive.

**Rig Location**  
1, 2, 4, 5, 6, 9, 10

#### Roughneck™ Quick Connect



Quick connect, high amperage, single conductor connectors built to take heavy abuse while providing a simple, secure and safe connection.

**Rig Location**  
2, 4, 5, 6, 9, 10

#### Cam-Lok™ Single Pole Series



Quickly connect and disconnect power systems safely. Used for motors, generators, indoor and outdoor lighting distribution panels and numerous other power applications.

**Rig Location**  
1, 2, 4, 5, 6, 9, 10

### Low to medium amp power

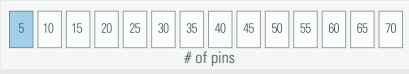

#### PowerMate™ Series



Supplies power to portable devices such as motor generator sets, compressors, heating and cooling, welders and lighting from 30 to 200A.

**Rig Location**  
2, 4, 5

#### PowerGard™ Series



Supplies power to lighting systems, lighting panels and portable hand tools on land-based rigs.

**Rig Location**  
1, 2, 3, 4, 5, 6, 7, 8, 9, 10

#### IEC 309 GHG 51 Series



Supplies power to portable devices with requirements of 16 to 125A and features an integrated AC3 rated disconnect switch. Reinforced polyester construction offers reliability from -20° to +55°C.

**Rig Location**  
7, 8, 9

### Multi-pin control

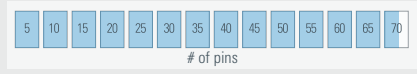

#### Roughneck™ Multi-pin Series



Heavy duty control and instrumentation multi-pin connectors for hazardous and harsh industrial use.

**Rig Location**  
1, 2, 4, 5, 6, 9, 10

#### Connectors for harsh/heavy industrial areas



#### Connectors for hazardous areas





**For more information:**

If further assistance is required, please contact an authorized Eaton Distributor, Sales Office, or Customer Service Department.

**U.S. (global headquarters):  
Eaton's Crouse-Hinds business**

1201 Wolf Street  
Syracuse, NY 13208

TEL: (866) 764-5454  
FAX: (315) 477-5179  
FAX Orders Only:  
(866) 653-0640

[crousecustomerctr@eaton.com](mailto:crousecustomerctr@eaton.com)

**Mexico/Latin America/  
Caribbean:**

TEL: 52-555-804-4000  
FAX: 52-555-804-4020

[ventascentromex@eaton.com](mailto:ventascentromex@eaton.com)

**Canada:**

Toll Free: 800-265-0502  
FAX: (800) 263-9504  
FAX Orders only:  
(866) 653-0645

**Eaton**  
1000 Eaton Boulevard  
Cleveland, OH 44122  
United States  
[Eaton.com](http://Eaton.com)

**Eaton's Crouse-Hinds business**  
1201 Wolf Street  
Syracuse, NY 13208  
[Crouse-Hinds.com](http://Crouse-Hinds.com)

© 2018 Eaton  
All Rights Reserved  
Printed in USA  
Publication No. 5163-0318  
March 2018

Eaton is a registered trademark.  
All other trademarks are property  
of their respective owners.

# PowerMate™ drilling pin and sleeve connectors



Powering Business Worldwide





# Safe. Reliable. Fast. Connections

The ideal rig power connection solution

- Longer product life
- Enhanced safety
- Reduced maintenance
- Easy to install



# PowerMate™ Series

Drilling rig pin and sleeve power connections



PowerMate™ is designed to support the modularity of drilling rig systems by providing safe and reliable power connections for rigging-up and rigging-down equipment quickly and efficiently.

#### The ideal rig power connection solution

- Longer product life
- Reduced maintenance
- Enhanced safety
- Easy-to-install

#### Compatible with all UL1686 Listed plugs and receptacles

- Eaton's Crouse-Hinds Arkтите®
- Appleton Powertite®
- Killark VersaMate®

#### Application

- On SCR/VFD houses to provide power to rig equipment such as shakers, agitators, lighting circuits, mud pumps, motors, etc.
- Quickly and efficiently connect power during rig-ups and disconnect power during rig-downs

#### EXCLUSIVE FEATURES

- Lockout plug
- Fixed safety insulator
- Diamond cable clamp
- Split pin contacts
- Suited for use with Type P cable

# Specifications & features

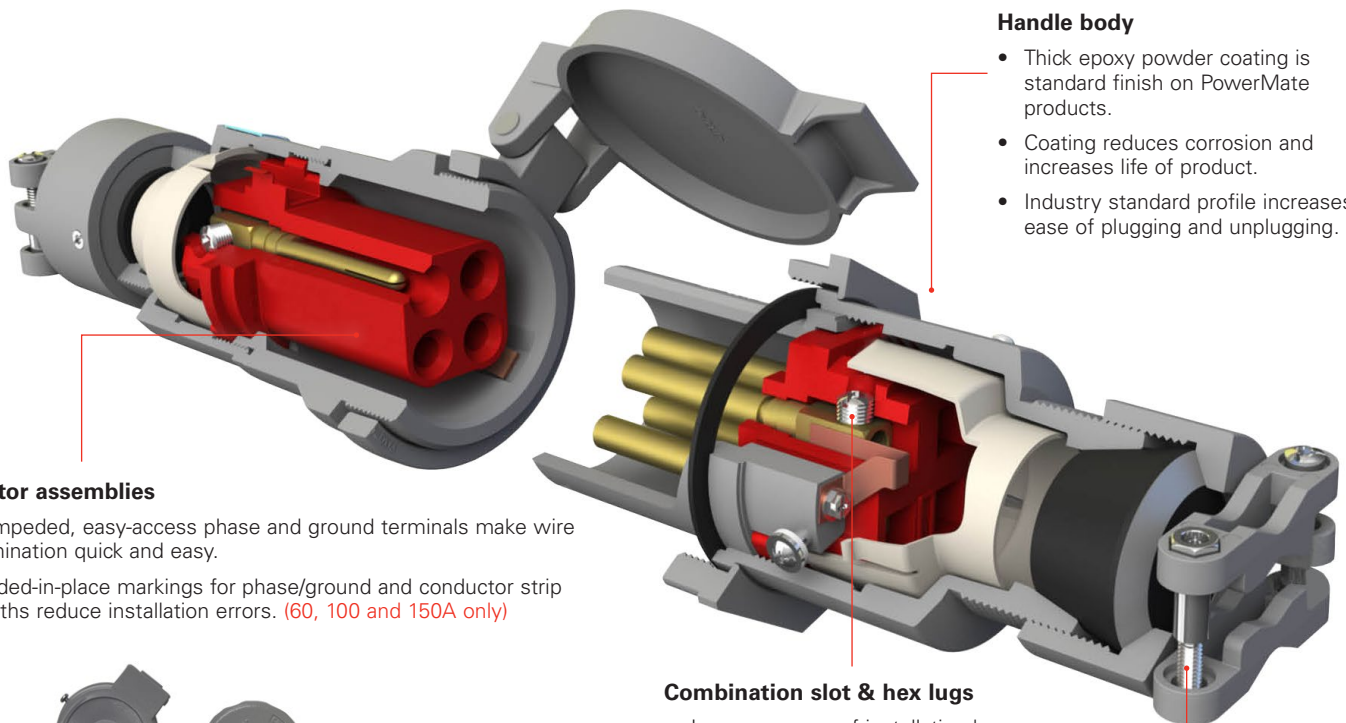

## Handle body

- Thick epoxy powder coating is standard finish on PowerMate products.
- Coating reduces corrosion and increases life of product.
- Industry standard profile increases ease of plugging and unplugging.

## Insulator assemblies

- Unimpeded, easy-access phase and ground terminals make wire termination quick and easy.
- Molded-in-place markings for phase/ground and conductor strip lengths reduce installation errors. (60, 100 and 150A only)



## Spring and threaded cover options

- Each 30, 60, 100 and 150A receptacle comes with both spring cap and threaded cap to provide a variety of cover options.
- 200A comes with spring cap and wing nuts to ensure environmental sealing.

## Combination slot & hex lugs

- Increases ease of installation by allowing for more than one option for installation tools.
- Hex head allows for easy achievement of specified torque value.

## Combination drive stainless steel hardware

- Increases ease of installation by allowing for more than one option for installation tools.
- Stainless steel external hardware eliminates corrosion on critical components and extends product life.



## Extended cable range

- Industry's largest cable diameter range.
- Specifically designed, third party tested and certified for use with Type P cable.
- Sealing system utilizes industry standard bushings.



## Enhanced nomenclature and nameplate

- Easily understandable nomenclature increases ease of part configuration identification.
- Mechanically attached nameplate ensures that critical information is permanently fixed to product.

## Exclusive features



### 8-point diamond cable clamps

- 8 points of contact around diameter of cable for increased grip and even distribution of pressure.
- Cable jacket does not get pinched, eliminating potential for damage to internal conductors.



### Lockout plug

- Guarantees isolated power supply with OSHA compliant lockout/tagout.
- Ensures plug cannot be inserted into receptacle when maintenance is being performed downstream of power supply.



### Split pin contact design

- Provides nearly 360° of contact at every insertion, ensuring protection against heat rise and eliminating arcing on critical surfaces.
- Self-wiping at every insertion to remove foreign particles that create electrical resistance and product failure.



### Fixed safety insulator

- Prevents electrical shock and shorts with plastic barrier between insulator body and metal housing.
- Fixed-in-place design ensures insulator will not be lost or discarded during cable termination process. (30, 60, 100 and 150A only)

### Electrical ratings

- 30, 60, 100, 150, 200A 600 VAC/250 VDC

### Certifications and compliances

- Plugs (CCP 30-150A, including CCP3034) hazardous location rated when used with Crouse-Hinds interlocked receptacles (ex. FSQC, EBBR models)
  - Class I, Division 1, Groups B, C, D (excludes 200A)
  - Class II, Division 1, Groups F, G (excludes 200A)
- CE marked (excludes RS option and 200A)
- UL standards
  - UL1682; UL1686; NEMA250; IEC60309-1; IEC60309-2
- CSA standard
  - CSA 22.2 No. 182.1
- Suited for use with Type P cable, flexible cord and cables rated for extra hard usage
- NEMA 4X



### Options

- **Special polarity** – receptacle interior rotated 22.5° to the right and plug changed to match. For use where two or more receptacles of the same ampere rating, style and number of poles are to be installed in the same area for use on different voltages and/or frequencies. Prevents insertion of a plug in a receptacle with different electrical rating.
- **Reverse service** – receptacle assembled with plug interior and plug assembled with receptacle interior. Used in applications where plug is energized to feed normally de-energized receptacle. Interiors are field interchangeable using only a screwdriver.
  - (\* excludes 150 and 200A)

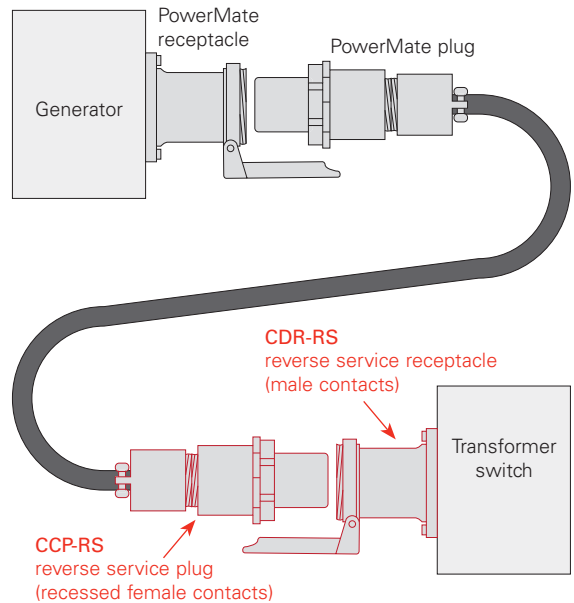

### Standard materials

- Receptacle housing, plug and cord connector bodies - high impact strength copper-free aluminum (less than 0.4% copper)
- Back boxes - cast aluminum
- Insulation - fiberglass reinforced polyester
- Contacts - naval brass

### Standard finishes

- Copper-free aluminum - epoxy powder coat
- Fiberglass reinforced polyester - natural (red)
- Naval brass - natural

## Additional features - 200 Amp

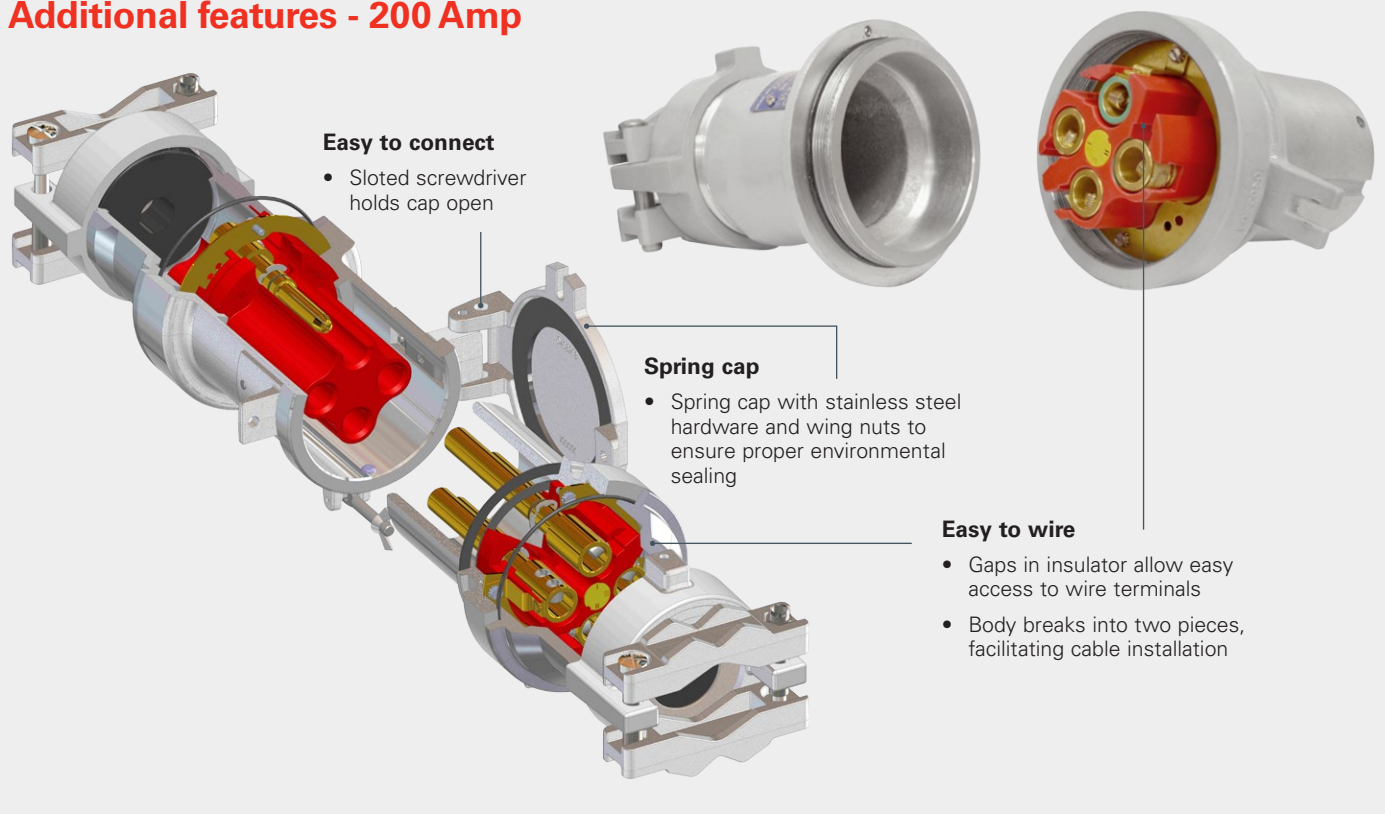



# Ordering information

Part number example and description

## CCP3034BC-RS

Eaton's Crouse-Hinds PowerMate™ plug, 30A, 3 wire, 4 pole, 0.390-1.375" cable range, reverse service

CCP
30
3
4
BC
-
RS

**Product type**

CCP	Plug
CDR	Receptacle
CRC	Connector
CDRE*	Receptacle with CEE back box
CDJA**	Receptacle with CJA back box

\* Available with 30A and 60A receptacle  
\*\* Available with 60A, 100A, 150A and 200A receptacle

**Wire**

2*	2 wire
3	3 wire
4	4 wire

\* Available with 30A, 60A and 100A product

**Pole**

2	2 pole
3	3 pole
4	4 pole

**Options**

-RS	Reverse service
-P4	Special polarity

**Amperage**

30	30 Amp
60	60 Amp
100	100 Amp
150	150 Amp
200	200 Amp

**Hub size (receptacle with back box only)\***

50	½"
75	¾"
100	1"
125	1-¼"
150	1-½"
200	2"
250	2-½"
300	3"
350	3-½"
400	4"
500	5"

**Cable range (plug & connector only)\***

BC	0.390 to 1.375"
CD	0.875 to 1.906"
DE	1.250 to 2.190"
E	1.875 to 2.500"
F	2.500 to 3.000"
G	3.000 to 3.500"

\* Cable range only applies to specific plug part numbers

\* Hub size only applies to specific receptacle part numbers

## Horsepower ratings

Amp rating	Voltage
30, 60, 100, 150, 200	600 VAC, 50 to 400Hz 250 VDC*

\* This guide is for reference only. Consult your local electrical codes before installation.

## Maximum horsepower for plug and receptacle combinations by input voltage

Typical horsepower ratings based on NEC Article 430 tables. HP ratings are based on the largest conductor size for each plug and receptacle combination.

Amp rating	Motor horsepower**		
	240V	480V	600V
30	15	30	40
60	20	40	50
100	30	60	75
150	40	75	100
200	60	125	150

\*\* Eaton's Crouse-Hinds recommends circuit breaking use be limited to emergency conditions only and that a horsepower rated switch or Crouse-Hinds interlocked receptacle be used for making and breaking under load.

## Grounding

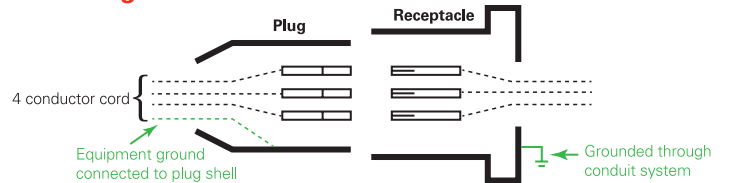

Style 1 units complete the grounding circuit through the metallic plug shell, receptacle housing or connector shell

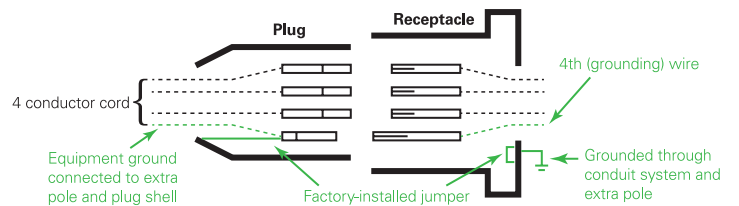

Style 2 units with metal housing have a separate designated ground contact that is bonded to the metallic housing. The metallic housing of the plug, receptacle or connector forms a parallel ground circuit through the receptacle or connector detent spring.

## Wire sizes





The wire size table lists the diameter of the wire recess in PowerMate plug and receptacle contacts so that maximum size of bare conductor can be determined. Range of wire sizes shown in table are intended only as a guide. Depending on type of wire used (building wire, flexible or extra flexible cable) and its construction (number and size of strands), bare copper diameters vary widely.

### Diameter: wire recess in plug & receptacle contacts

Amperage rating	Contact type	Diameter of recess	Wire size* extra flex
<b>30 (2, 3 &amp; 4 pole)</b>	Pressure	0.281"	#10 to #8
<b>60 (2, 3 &amp; 4 pole)</b>	Pressure	0.312"	#8 to #4
<b>100 (2, 3 &amp; 4 pole)</b>	Pressure	0.390"	#4 to #2
<b>150 (4 pole)</b>	Pressure	0.390"	#2 to 1/0
<b>200 (3 &amp; 4 pole)</b>	Pressure	0.687"	2/0 to 250 MCM

\* Do not use wire size smaller than minimum size recommended

## 30 Amp: Receptacles, plugs, connectors





Description & configuration	Receptacle	Plug		Cord connector		
		Cable range	Part number	Cable range	Part number	
2 wire 2 pole style 1		<b>CDR3022</b>	0.390-1.375"	<b>CCP3022BC</b>	0.390-1.375"	<b>CRC3022BC</b>
2 wire 3 pole style 2		<b>CDR3023</b>	0.390-1.375"	<b>CCP3023BC</b>	0.390-1.375"	<b>CRC3023BC</b>
3 wire 3 pole style 1		<b>CDR3033</b>	0.390-1.375"	<b>CCP3033BC</b>	0.390-1.375"	<b>CRC3033BC</b>
3 wire 4 pole style 2		<b>CDR3034</b>	0.390-1.375"	<b>CCP3034BC</b>	0.390-1.375"	<b>CRC3034BC</b>
4 wire 4 pole style 1		<b>CDR3044</b>	0.390-1.375"	<b>CCP3044BC</b>	0.390-1.375"	<b>CRC3044BC</b>

## Back boxes

Hub size	CEE	CERH	CERC
½"	<b>CEE13</b>	<b>CERH13</b>	<b>CERC13</b>
1-¼"	<b>CEE23</b>	<b>CERH23</b>	<b>CERC23</b>
1-½"	<b>CEE33</b>	<b>CERH33</b>	<b>CERC33</b>

- Standard Corro-Free™ epoxy powder coat finish for increased corrosion resistance
- For optional reversed interior, use suffix **-RS**
- For optional rotated interior, use suffix **-P4**
- Maximum conductor size (wire well) 0.281"

## 60 Amp: Receptacles, plugs, connectors





Description & configuration	Receptacle	Plug		Cord connector		
		Cable range	Part number	Cable range	Part number	
2 wire 2 pole style 1		<b>CDR6022</b>	0.440-1.375"	<b>CCP6022BC</b>	0.440-1.375"	<b>CRC6022BC</b>
2 wire 3 pole style 2		<b>CDR6023</b>	0.440-1.375"	<b>CCP6023BC</b>	0.440-1.375"	<b>CRC6023BC</b>
3 wire 3 pole style 1		<b>CDR6033</b>	0.440-1.375"	<b>CCP6033BC</b>	0.440-1.375"	<b>CRC6033BC</b>
3 wire, 4 pole style 2		<b>CDR6034</b>	0.440-1.375"	<b>CCP6034BC</b>	0.440-1.375"	<b>CRC6034BC</b>
4 wire 4 pole style 1		<b>CDR6044</b>	0.440-1.375"	<b>CCP6044BC</b>	0.440-1.375"	<b>CRC6044BC</b>

## Back boxes

Hub size	CEE	CERH	CJA	CERC
½"	<b>CEE36</b>	<b>CERH36</b>	<b>CJA310</b>	<b>CERC36</b>
1-¼"	<b>CEE46</b>	<b>CERH46</b>	<b>CJA410</b>	<b>CERC46</b>
1-½"	<b>CEE56</b>	<b>CERH56</b>	<b>CJA510</b>	<b>CERC56</b>
2"	-	-	<b>CJA610</b>	-

- Standard Corro-Free™ epoxy powder coat finish for increased corrosion resistance
- For optional reversed interior, use suffix **-RS**
- For optional rotated interior, use suffix **-P4**
- Maximum conductor size (wire well) 0.312"

## 100 Amp: Receptacles, plugs, connectors



Description & configuration	Receptacle	Plug		Cord connector	
		Cable range	Part number	Cable range	Part number
2 wire 2 pole style 1	 <b>CDR1022</b>	0.875-1.906"	<b>CCP1022CD</b>	0.875-1.906"	<b>CRC1022CD</b>
2 wire 3 pole style 2	 <b>CDR1023</b>	0.875-1.906"	<b>CCP1023CD</b>	0.875-1.906"	<b>CRC1023CD</b>
3 wire 3 pole style 1	 <b>CDR1033</b>	0.875-1.906"	<b>CCP1033CD</b>	0.875-1.906"	<b>CRC1033CD</b>
3 wire 4 pole style 2	 <b>CDR1034</b>	0.875-1.906"	<b>CCP1034CD</b>	0.875-1.906"	<b>CRC1034CD</b>
4 wire 4 pole style 1	 <b>CDR1044</b>	0.875-1.906"	<b>CCP1044CD</b>	0.875-1.906"	<b>CRC1044CD</b>

## Back boxes: 100 & 150 Amp





Hub size	CJA	CJA adapter only
1"	<b>CJA310</b>	
1-¼"	<b>CJA410</b>	
1-½"	<b>CJA510</b>	<b>CJA100</b>
2"	<b>CJA610</b>	

- Standard Corro-Free™ epoxy powder coat finish for increased corrosion resistance
- For optional reversed interior, use suffix **-RS**
- For optional rotated interior, use suffix **-P4**
- Maximum conductor size (wire well) 0.390"

## 150 Amp: Receptacles, plugs, connectors

Description & configuration	Receptacle	Plug		Cord connector	
		Cable range	Part number	Cable range	Part number
3 wire 4 pole style 2	 <b>CDR15034</b>	0.875-1.906"	<b>CCP15034CD</b>	0.875-1.906"	<b>CRC15034CD</b>
		1.250-2.190"	<b>CCP15034DE</b>	1.250-2.190"	<b>CRC15034DE</b>
4 wire 4 pole style 1	 <b>CDR15044</b>	0.875-1.906"	<b>CCP15044CD</b>	0.875-1.906"	<b>CRC15044CD</b>
		1.250-2.190"	<b>CCP15044DE</b>	1.250-2.190"	<b>CRC15044DE</b>

## 200 Amp: Receptacles, plugs, connectors

Description & configuration	Receptacle	Plug		Cord connector	
		Cable range	Part number	Cable range	Part number
2 wire, 3 pole style 2	 <b>CDR20023</b>	0.875-1.906"	<b>CCP20023CD</b>	0.875-1.906"	<b>CRC20023CD</b>
		1.875-2.500"	<b>CCP20023E</b>	1.875-2.500"	<b>CRC20023E</b>
3 wire, 3 pole style 1	 <b>CDR20033</b>	0.875-1.906"	<b>CCP20033CD</b>	0.875-1.906"	<b>CRC20033CD</b>
		1.875-2.500"	<b>CCP20033E</b>	1.875-2.500"	<b>CRC20033E</b>
3 wire 4 pole style 2	 <b>CDR20034</b>	0.875-1.906"	<b>CCP20034CD</b>	0.875-1.906"	<b>CRC20034CD</b>
		1.875-2.500"	<b>CCP20043E</b>	1.875-2.500"	<b>CRC20034E</b>
4 wire 4 pole style 1	 <b>CDR20044</b>	0.875-1.906"	<b>CCP20044CD</b>	0.875-1.906"	<b>CRC20044CD</b>
		1.875-2.500"	<b>CCP20044E</b>	1.875-2.500"	<b>CRC20044E</b>

## Back boxes

Hub size	CJA	CJAC (through-feed)	CJA adapter only
1-½"	<b>CJA520</b>	-	
2"	<b>CJA620</b>	-	<b>CJA200</b>
2-½"	<b>CJA720</b>	<b>CJAC720</b>	

- Standard Corro-Free™ epoxy powder coat finish for increased corrosion resistance
- For optional reversed interior, use suffix **-RS**
- For optional rotated interior, use suffix **-P4**
- Maximum conductor size (wire well) 0.281"



## Dimensions

### Receptacle

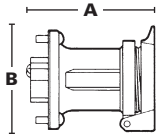

### Plug

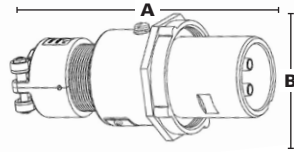

### Connector

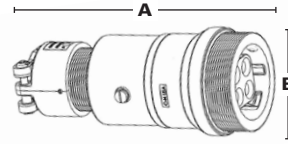

Receptacle	A	B
30A	2.8750	3.3750
60A, 3 pole	4.2500	4.5000
60A, 4 pole	4.2500	4.5000
100A, 3 pole	5.2500	4.2500
100A, 4 pole	5.2500	4.2500
150A CD	5.2500	4.2500
150A DE	5.2500	4.2500
200A	7.8750	7.1875

Plug	A	B
30A	6.5000	2.3125
60A, 3 pole	8.1700	3.6250
60A, 4 pole	8.1700	3.7500
100A, 3 pole	10.8000	3.7500
100A, 4 pole	10.8000	4.1250
150A CD	10.8000	4.1250
150A DE	10.8000	4.1250
200A	13.1250	7.5000

Connector	A	B
30A	6.6000	2.5625
60A, 3 pole	8.3000	2.3125
60A, 4 pole	8.3000	2.3125
100A, 3 pole	11.5000	3.1875
100A, 4 pole	11.5000	3.4375
150A CD	11.5000	3.4375
150A DE	11.5000	3.4375
200A	14.0000	8.2000

### Back boxes: 30 & 60A only

Part number	Rating	Hub Size	A	B
CEE13	30A	½"	1.8440	0.6875
CEE23	30A	¾"	1.8440	0.8125
CEE33	30A	1"	1.9690	0.9375
CEE36	60A	1"	2.5625	0.9375
CEE46	60A	1-¼"	2.6250	1.1875
CEE56	60A	1-½"	2.6875	1.3125

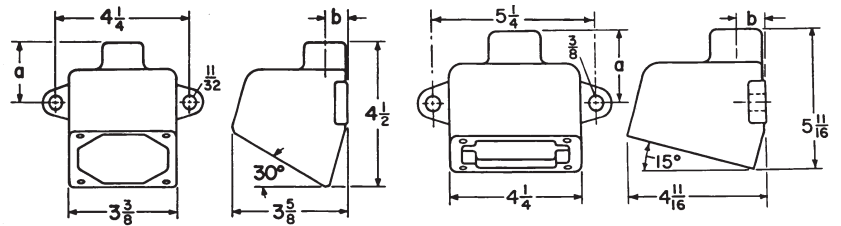

### Back boxes with 60, 100, 150 & 200A angle adapters

Part number	Rating	Hub Size	A	B	C	D	E	F
CJA310	60, 100, 150A	1"	5.8750	8.0000	7.4375	4.8750	7.0000	15°
CJA410	60, 100, 150A	1-¼"	5.8750	8.0000	7.4375	4.8750	7.0000	15°
CJA510	60, 100, 150A	1-½"	5.8750	8.0000	7.4375	4.8750	7.0000	15°
CJA610	60, 100, 150A	2"	5.8750	8.0000	8.0000	4.8750	7.0000	15°
CJA520	200A	1-½"	8.0000	10.7500	9.8750	6.7500	9.5000	45°
CJA620	200A	2"	8.0000	10.7500	9.8750	6.7500	9.5000	45°
CJA720	200A	2-½"	8.0000	10.7500	9.8750	6.7500	9.5000	45°
CJAC720	200A	2-½"	8.0000	10.7500	9.8750	6.7500	9.5000	45°

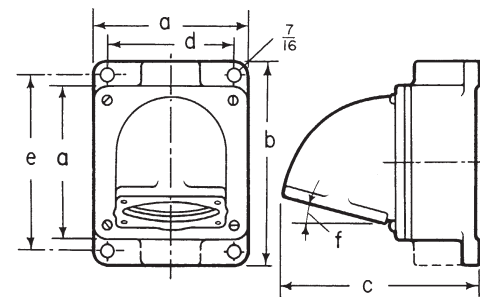

- Back boxes are standard with Corro-Free™ epoxy powder coat finish for increased corrosion resistance
- Through feed back boxes are furnished with one close-up plug in bottom recessed hub
- CJA back boxes are recommended when additional wiring space is required
- The angle adapter on CJA back boxes can be installed at 90° rotations, making it possible to enter hub from several directions

## Replacement parts

### Standard replacement parts

Complete insulator assembly		30A	60A	100A	150A	200A
2W2P	CDR-CRC	CRI-3022	CRI-6022	CRI-1022	–	–
	CCP	CPI-3022	CPI-6022	CPI-1022	–	–
2W3P	CDR-CRC	CRI-3023	CRI-6023	CRI-1023	–	CRI-20023
	CCP	CPI-3023	CPI-6023	CPI-1023	–	CPI-20023
3W3P	CDR-CRC	CRI-3033	CRI-6033	CRI-1033	–	CRI-20033
	CCP	CPI-3033	CPI-6033	CPI-1033	–	CPI-20033
3W4P	CDR-CRC	CRI-3034	CRI-6034	CRI-1034	CRI-15034	CRI-20034
	CCP	CPI-3034	CPI-6034	CPI-1034	CPI-15034	CPI-20034
4W4P	CDR-CRC	CRI-3044	CRI-6044	CRI-1044	CRI-15044	CRI-20044
	CCP	CPI-3044	CPI-6044	CPI-1044	CPI-15044	CPI-20044

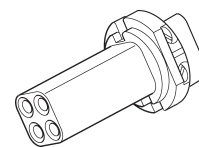

CRI receptacle & connector interior

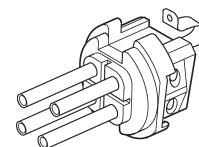

CPI plug interior

### Miscellaneous replacement parts

Amperage	Configuration	CDR spring cover	CDR threaded cover	CCP fastening ring	Bushing kits
30	2, 3 & 4 pole	PTSC30	PTTC30	CLMPR30	PTGB30
60	2, 3 & 4 pole	PTSC60A	PTTC60A	CLMPR23P60	PTGB60
		PTSC60B	PTTC60B	CLMPR4P60	
100	2, 3 & 4 pole	PTSC100A	PTTC100A	CLMPR23P100	PTGBCD
		PTSC100B	PTTC100B	CLMPR4P100	
150	4 pole	PTSC150B	PTTC150B	CLMPR4P150	PTGBCD (CD size)
					PTGBDE (DE size)

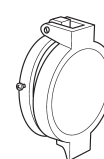

Spring cover



Threaded cover



Bushing kit

Amperage	Configuration	CDR spring cover	Brass retaining ring	Plug contact	Plug ground contact	Receptacle contact	Receptacle ground contact	Bushing kit
200A	3 pole	PTLC200	PTBR2003	PTPC200	PTPC200G	PTRC200	PTRC200G	PTGB200CD (CD size)
	4 pole		PTBR2004					PTGB200E (E size)

- 1 Derrick/Mast
- 2 VFD/Generators
- 3 Fuel Tank
- 4 Motor Control/VFD/SCR House
- 5 Doghouse/ Operator's House
- 6 Power/Pump Station
- 7 Shale Shaker
- 8 Mud Tanks/Pumps
- 9 Drawworks & Top Drive
- 10 Drilling Floor

# Full portfolio of land-based powering solutions

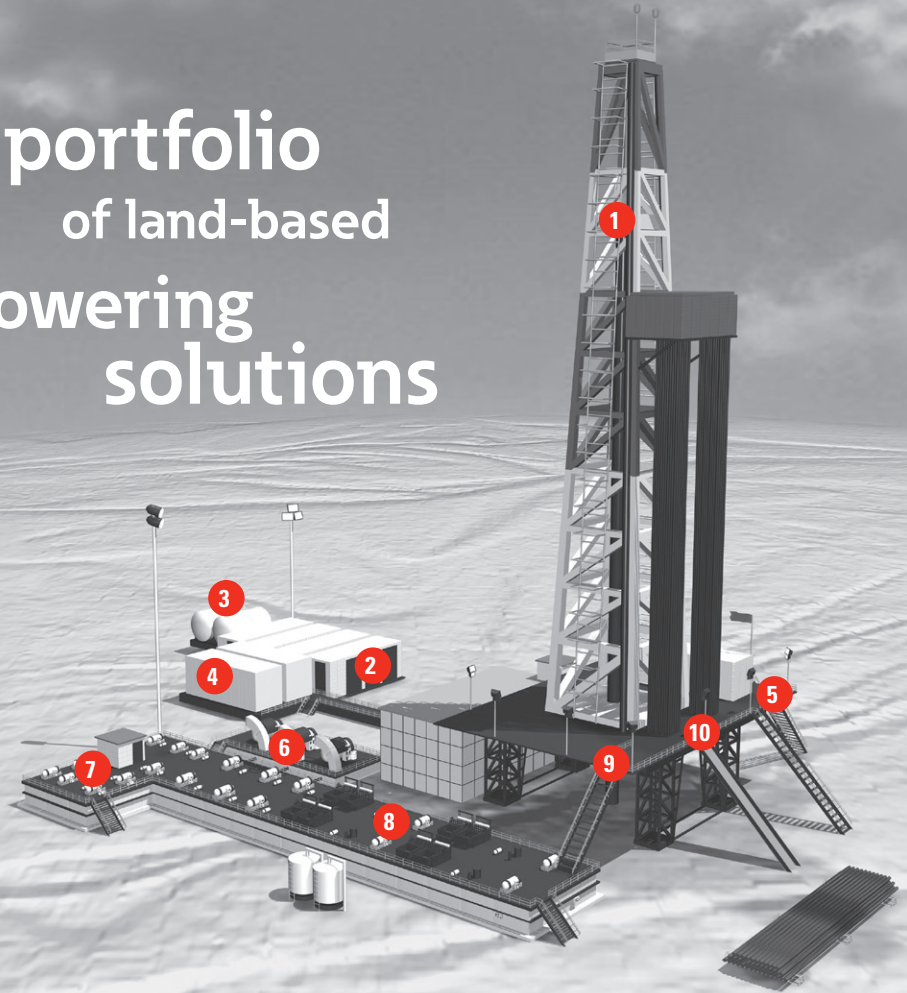

## Crouse-Hinds drilling solutions

### Single pole power

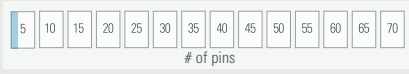

#### Roughneck™ Single Pole Series



Secure, single pole power, rated to 1135A for use in hazardous and normal locations. Ideal for delivering power to the top drive.

**Rig Location**  
1, 2, 4, 5, 6, 9, 10

#### Roughneck™ Quick Connect



Quick connect, high amperage, single conductor connectors built to take heavy abuse while providing a simple, secure and safe connection.

**Rig Location**  
2, 4, 5, 6, 9, 10

#### Cam-Lok™ Single Pole Series



Quickly connect and disconnect power systems safely. Used for motors, generators, indoor and outdoor lighting distribution panels and numerous other power applications.

**Rig Location**  
1, 2, 4, 5, 6, 9, 10

### Low to medium amp power

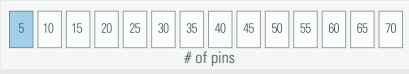

#### PowerMate™ Series



Supplies power to portable devices such as motor generator sets, compressors, heating and cooling, welders and lighting from 30 to 200A.

**Rig Location**  
2, 4, 5

#### PowerGard™ Series



Supplies power to lighting systems, lighting panels and portable hand tools on land-based rigs.

**Rig Location**  
1, 2, 3, 4, 5, 6, 7, 8, 9, 10

#### IEC 309 GHG 51 Series



Supplies power to portable devices with requirements of 16 to 125A and features an integrated AC3 rated disconnect switch. Reinforced polyester construction offers reliability from -20° to +55°C.

**Rig Location**  
7, 8, 9

### Multi-pin control

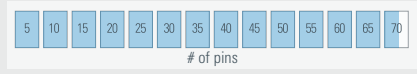

#### Roughneck™ Multi-pin Series



Heavy duty control and instrumentation multi-pin connectors for hazardous and harsh industrial use.

**Rig Location**  
1, 2, 4, 5, 6, 9, 10

#### Connectors for harsh/heavy industrial areas



#### Connectors for hazardous areas





**For more information:**

If further assistance is required, please contact an authorized Eaton Distributor, Sales Office, or Customer Service Department.

**U.S. (global headquarters):  
Eaton's Crouse-Hinds business**

1201 Wolf Street  
Syracuse, NY 13208

TEL: (866) 764-5454  
FAX: (315) 477-5179  
FAX Orders Only:  
(866) 653-0640

[crousecustomerctr@eaton.com](mailto:crousecustomerctr@eaton.com)

**Mexico/Latin America/  
Caribbean:**

TEL: 52-555-804-4000  
FAX: 52-555-804-4020

[ventascentromex@eaton.com](mailto:ventascentromex@eaton.com)

**Canada:**

Toll Free: 800-265-0502  
FAX: (800) 263-9504  
FAX Orders only:  
(866) 653-0645

**Eaton**  
1000 Eaton Boulevard  
Cleveland, OH 44122  
United States  
[Eaton.com](http://Eaton.com)

**Eaton's Crouse-Hinds business**  
1201 Wolf Street  
Syracuse, NY 13208  
[Crouse-Hinds.com](http://Crouse-Hinds.com)

© 2018 Eaton  
All Rights Reserved  
Printed in USA  
Publication No. 5163-0318  
March 2018

Eaton is a registered trademark.  
All other trademarks are property  
of their respective owners.