

B6IC-LED 6" NEW CONSTRUCTION IC LED HOUSING

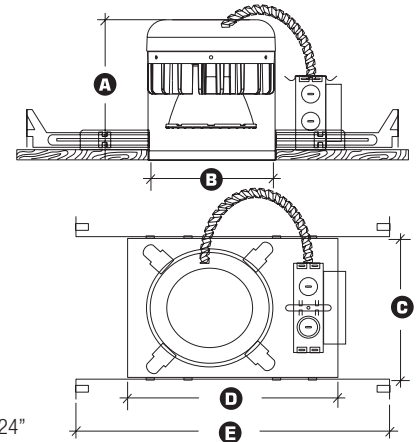

900 LUMENS **IC RATED**

INPUT VOLT.	INPUT FREQ.	INPUT CUR.	INPUT POWER	THD	POWER FACTOR	LUMENS
120/277	50/60Hz	150mA/65mA	18W(+/-5%)	<20%	>0.9	900
120/277	50/60Hz	116mA/50mA	14W(+/-5%)	<20%	>0.9	650



DESCRIPTION - 6" LED dedicated New Construction IC housing with integral LED heat management casting and driver (installed on junction box). Designed for new construction installations and suitable for use in insulation covered or non-insulation covered ceilings. Lighting is smooth and comfortable while using 75% less energy than the equivalent 65W BR30 & 75W BR30 and 25% less than the common 18W & 26W CFL luminaire. Plus, the eco-friendly Elite LED system features 70% lumen maintenance at 72,000 hours life, with Energy Star and California Title-24 compliances.

FEATURES - Greater light output than an 18W & 26W CFL or a 65W BR30 & 75W BR30 while consuming less than 14W & 18W of power. Elite LED luminaires are ideally suited for use in hospitality, health care, commercial, retail and residential applications.

OPTICS - Elite's optics gather the light scattered by the LED chip, shape it into a functional beam with state of the art reflectors, integrate the light through a smooth lens to minimize brightness, then top it all of with a glare reducing cone that has a 55-degree cut-off. Now you have the Elite engineered, superior quality, light engine; producing over 650 & 900 lumens.

DURABILITY - Die-cast aluminum heat management system is engineered for extremely long life and service period. Heat sink is attached to top of housing. The LED light engine is attached to the die-cast heat sink and is easily replaceable and upgradable. Life tests have shown the Elite light engine output will be maintained at 70% of initial at 50,000 hours of operation. Our LED driver is rated for 50 to 60 Hz, produces less than 20% THD, has a power factor between 0.90 and 1.00 and is thermally protected for additional safety. Elite's driver is installed on the junction box cover so it may be serviced from below the ceiling.

REPEATABLE - All Elite LED luminaires are rated at 90+ CRI as rated and tested to LM-79 and LM-80 standards by a certified laboratory. California Title 24-2013 and Energy Star compliance are standard.

DIMMABLE - The Elite LED system is fully dimmable down to 10% of initial light output with a 0-10 Volt dimmer when ordered with the following option (DIM10-MVOLT). Fixtures can be shipped with a Lutron Hi-lume A series Driver which can be dimmed with Lutron Dimming Systems when ordered with the following options (120-LUTH, 277-LUTH). Triac & Electronic Low Voltage dimming driver also available when ordered with the following options (DIMTR-120). Consult Factory for details.

HOUSING - Die-formed aluminum and galvanized steel for maximum heat dissipation and rust protection. Housing adjusts vertically in plaster frame to accommodate 1/2" to 1-3/8" thick ceiling. Housing is IC rated for direct contact with insulation and can be used in IC and NON-IC applications. May be installed in 2" x 8" joist construction.



JUNCTION BOX - UL Listed for through-branch circuit wiring, provided with four 1/2" knockouts, one 3/4" knockout and four Romex knockouts with true pry-out slots and strain clamps. Designed for straight through conduit runs. Driver is installed on the junction box cover so it may be serviced from below the ceiling.

THERMAL PROTECTION - Standard thermal protection device guards against improper installation and misuse of insulation material.

BAR HANGERS - Preinstalled bar hangers allow housing to be positioned and locked at any point within a 24" joist span. They can be positioned on either the long or short axis of the housing and can be shortened for 12" joists. They contain a double-headed real nail for secure attachment into the joist. Bar hanger nails are installed on a 20° downward angle for better contact, and the 90° pivoting mounting plate makes installation fast and accurate. Bar hangers can fit onto T-Bar spline with additional slots and holes for special mounting methods if necessary.

OUR WORD - The Elite LED lighting system carries a five-year carefree warranty for parts and components. (Labor not included.)

LISTING

c-UL-us - listed for Damp location
 c-UL-us - listed for feed Through Wiring
 c-UL-us - listed for Direct Contact With Insulation
 LM79 / LM80

Covered by U.S. Patent Numbers: D6423175S, 7717390B1, D615239S

DIMMING INFORMATION

DIMTR (Triac & Electronic Low Voltage Dimming)
 DIM10 (0-10V Dimming)
 LUTH (Lutron® Hi-lume® Dimming)

ITEM SELECTOR: Example: B6IC-LED-900L-DIM10-MVOLT-MD-30K-AT-L631-W-WH

*LENSED TRIMS AVAILABLE ONLY IN 650 LUMENS

TYPE	650L SERIES	900L SERIES	OPTICS	CCT	CRI	AIR-SHUT	EMERGENCY	TRIM	BAFFLE	REFLECTOR	TRIM/RING
B6IC-LED	<input type="checkbox"/> 650L-DIMTR-120 <input type="checkbox"/> 650L-LUTH-120 <input type="checkbox"/> 650L-LUTH-277 <input type="checkbox"/> 650L-DIM10-MVOLT	<input type="checkbox"/> 900L-DIMTR-120 <input type="checkbox"/> 900L-LUTH-120 <input type="checkbox"/> 900L-LUTH-277 <input type="checkbox"/> 900L-DIM10-MVOLT	<input type="checkbox"/> MD (Medium)	<input type="checkbox"/> 27K <input type="checkbox"/> 30K <input type="checkbox"/> 35K <input type="checkbox"/> 40K <input type="checkbox"/> 50K (85+ CRI Only)	<input type="checkbox"/> 85+ <input type="checkbox"/> 90+	<input type="checkbox"/> AT	<input type="checkbox"/> EMG	<input type="checkbox"/> L631 <input type="checkbox"/> L635* <input type="checkbox"/> L652* <input type="checkbox"/> L687* <input type="checkbox"/> L607 <input type="checkbox"/> L636* <input type="checkbox"/> L612* <input type="checkbox"/> L681* <input type="checkbox"/> L611 <input type="checkbox"/> L657* <input type="checkbox"/> L645* <input type="checkbox"/> L688* <input type="checkbox"/> L622 <input type="checkbox"/> L659* <input type="checkbox"/> L601* <input type="checkbox"/> L685* <input type="checkbox"/> L656* <input type="checkbox"/> L658* <input type="checkbox"/> L601L* <input type="checkbox"/> L680* <input type="checkbox"/> L676* <input type="checkbox"/> L641* <input type="checkbox"/> L605* <input type="checkbox"/> L689* <input type="checkbox"/> L675* <input type="checkbox"/> L642* <input type="checkbox"/> L605L* <input type="checkbox"/> L696*	<input type="checkbox"/> W <input type="checkbox"/> BZ <input type="checkbox"/> P <input type="checkbox"/> CL <input type="checkbox"/> SN <input type="checkbox"/> CP <input type="checkbox"/> BZ <input type="checkbox"/> RG <input type="checkbox"/> MB <input type="checkbox"/> W <input type="checkbox"/> SN <input type="checkbox"/> SHZ	<input type="checkbox"/> BK <input type="checkbox"/> WH <input type="checkbox"/> CH <input type="checkbox"/> PB <input type="checkbox"/> SN <input type="checkbox"/> CP <input type="checkbox"/> BZ	



LED
6"

6 INCH NEW CONSTRUCTION IC LED HOUSING

6" LED L600 BAFFLE TRIMS

L631W-WH - PHENOLIC STEPPED BAFFLE



Photometric Multiplier 1.0

BAFFLE FINISH: W-WHITE (ORDERING INFORMATION) **L631W- XX**
RING FINISH:

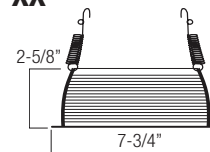
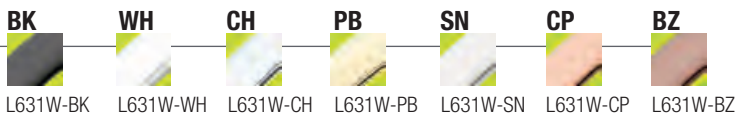

L631P-BK - PHENOLIC STEPPED BAFFLE



Photometric Multiplier .75

BAFFLE FINISH: P-BLACK (ORDERING INFORMATION) **L631P- XX**
RING FINISH:

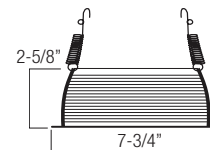
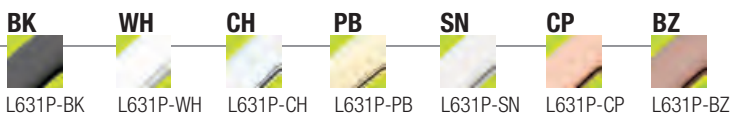

L631SN-SN - METAL STEPPED BAFFLE



Photometric Multiplier .92

BAFFLE FINISH: SN-SATIN NICKEL (ORDERING INFORMATION) **L631SN- XX**
RING FINISH:

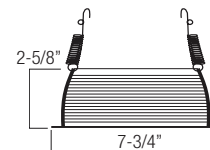
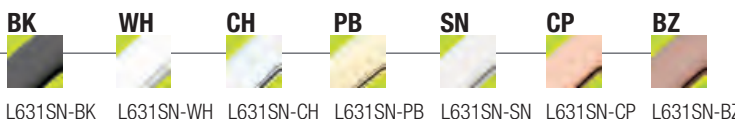

L631CP-CP - METAL STEPPED BAFFLE



Photometric Multiplier .87

BAFFLE FINISH: CP-COPPER (ORDERING INFORMATION) **L631CP- XX**
RING FINISH:

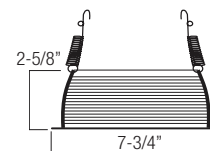
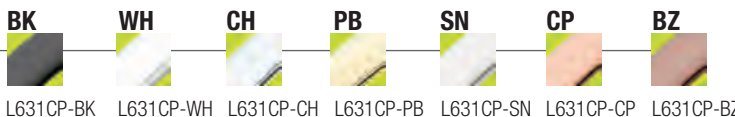

L631BZ-BZ - METAL STEPPED BAFFLE



Photometric Multiplier .85

BAFFLE FINISH: BZ-BRONZE (ORDERING INFORMATION) **L631BZ- XX**
RING FINISH:

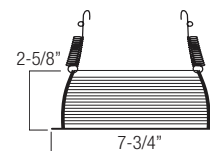

B61C-LED-650L-DIM10-120-MD-40K-AT-L631-W-WH

TEST NO.: EL-111333
 LUMENS: 754
 SPACING CRITERIA: 0.76

Candle Power Distribution Curve (Candela)

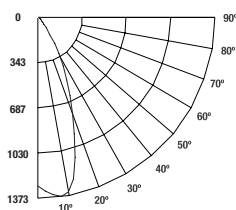

Candela Distribution

	Q
0	1282
5	1326
15	1057
25	571
35	263
45	104
55	20
65	10
75	5
85	2
90	1

Zonal Lumen Summary

Zone	Lumens	%Lamp	%Fixture
0-20	376.00	50.00	49.90
0-30	591.14	78.60	78.40
0-40	682.55	90.80	90.50
0-60	738.76	98.30	98.00
0-80	751.80	100.00	99.70
0-90	753.81	100.30	100.00



LED
6"

6 INCH BAFFLE LED TRIMS

L611W-WH - BAFFLE WALL WASH (ORDERING INFORMATION) L611X- XX-WH

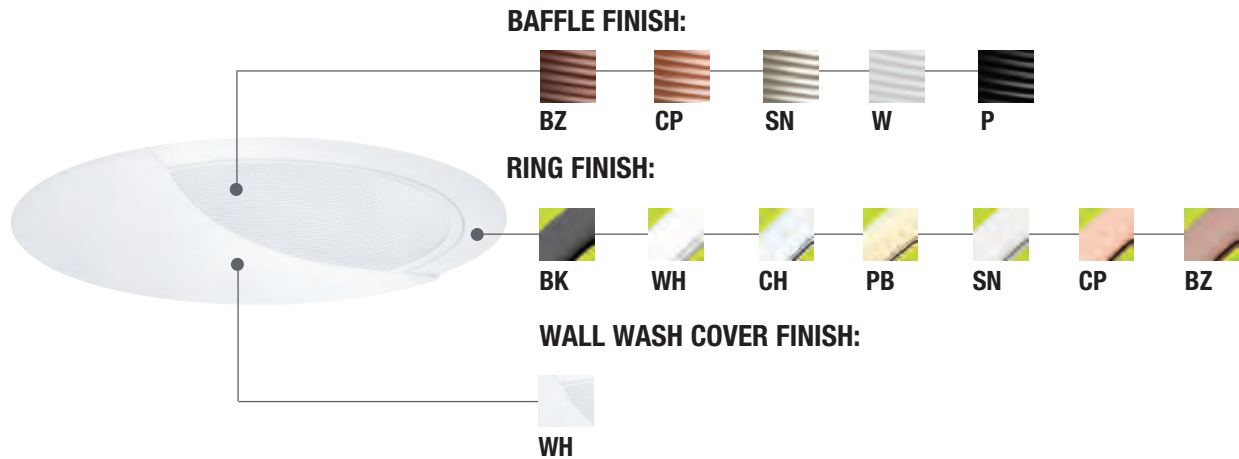

6" LED L600 REFLECTOR TRIMS

L607CL-WH - REFLECTOR



Photometric Multiplier 1.0

REFLECTOR FINISH: CL-CLEAR (ORDERING INFORMATION) **L607CL- XX**

RING FINISH:

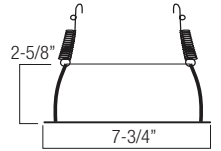
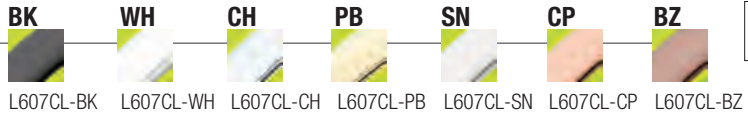

L607MB-WH - REFLECTOR



Photometric Multiplier .77

REFLECTOR FINISH: MB-BLACK (ORDERING INFORMATION) **L607MB- XX**

RING FINISH:

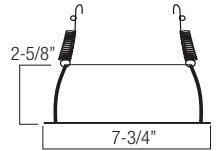

L607RG-WH - REFLECTOR



Photometric Multiplier .90

REFLECTOR FINISH: RG-GOLD (ORDERING INFORMATION) **L607RG- XX**

RING FINISH:

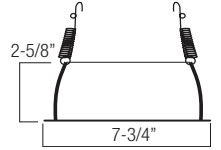

L607W-WH - REFLECTOR



Photometric Multiplier .95

REFLECTOR FINISH: W-WHITE (ORDERING INFORMATION) **L607W- XX**

RING FINISH:

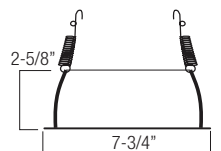
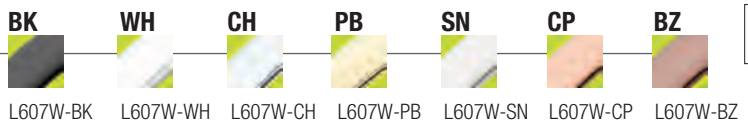

L607CP-CP - REFLECTOR



Photometric Multiplier .90

REFLECTOR FINISH: CP-COPPER (ORDERING INFORMATION) **L607CP- XX**

RING FINISH:

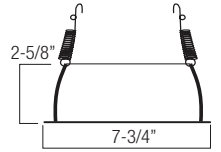
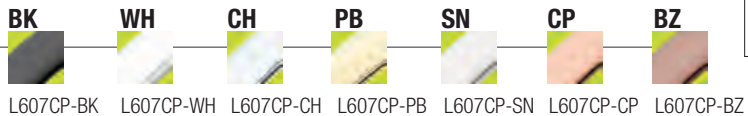

B6IC-LED-650L-DIM10-120-MD-40K-AT-L631-W-WH

Test no.: EL-111333

Lumens: 754

Spacing criteria: 0.76



Candle Power Distribution Curve (Candela)

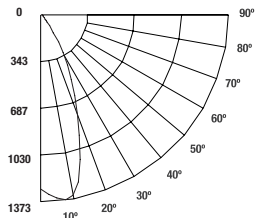

Candela Distribution

Candela	Q
0	1282
5	1326
15	1057
25	571
35	263
45	104
55	20
65	10
75	5
85	2
90	1

Zonal Lumen Summary

Zone	Lumens	%Lamp	%Fixture
0-20	376.00	50.00	49.90
0-30	591.14	78.60	78.40
0-40	682.55	90.80	90.50
0-60	738.76	98.30	98.00
0-80	751.80	100.00	99.70
0-90	753.81	100.30	100.00

6" LED L600 REFLECTOR TRIMS

L622W-WH - REFLECTOR WALL WASH (ORDERING INFORMATION) L622X- XX-WH



REFLECTOR FINISH:



RING FINISH:



WALL WASH COVER FINISH:

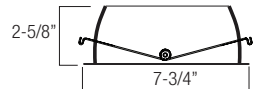

L607SN-SN - Reflector

REFLECTOR FINISH: SN-SATIN NICKEL (ORDERING INFORMATION) L607SN- XX

RING FINISH:



Photometric Multiplier .87

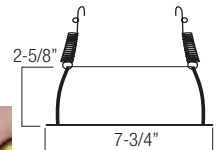
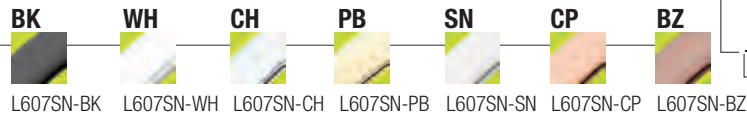

L607BZ-BZ - REFLECTOR

REFLECTOR FINISH: BZ-BRONZE (ORDERING INFORMATION) L607BZ- XX

RING FINISH:



Photometric Multiplier .87

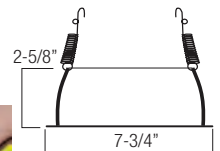
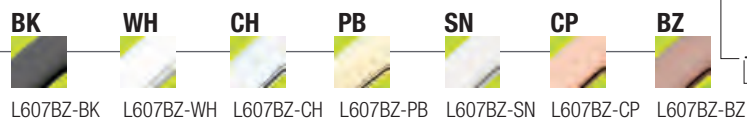

L607SHZ-WH - REFLECTOR

REFLECTOR FINISH: SHZ-SATIN HAZE (ORDERING INFORMATION) L607SHZ- XX

RING FINISH:

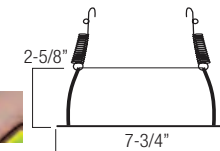
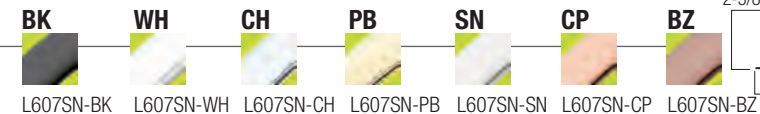

B6IC-LED-900L-DIM10-120-MD-40K-AT-L607-CL-WH

Test no.: EL-111344

Lumens: 872

Spacing criteria: 0.64



Candle Power Distribution Curve (Candela)

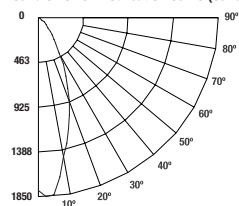

Candela Distribution

0	Q
0	1790
5	1801
15	1148
25	657
35	318
45	126
55	22
65	9
75	1
85	1
90	0

Zonal Lumen Summary

Zone	Lumens	%Lamp	%Fixture
0-20	456.67	52.50	52.30
0-30	708.95	81.50	81.30
0-40	810.37	93.20	92.90
0-60	866.26	99.60	99.30
0-80	872.08	100.30	100.00
0-90	872.44	100.30	100.00

6" LED L600 LENSED BAFFLE TRIMS

L656W-WH - BAFFLE WITH FROSTED DOME SHOWER LENS (ORDERING INFORMATION) L656X- XX



Photometric Multiplier .85

BAFFLE FINISH:



RING FINISH:



LENSED TRIMS AVAILABLE IN
650L 14 WATTS | **900L** 18 WATTS | **1200L** 24 WATTS



L676W-WH - BAFFLE WITH FROSTED LENS (ORDERING INFORMATION) L676X- XX



Photometric Multiplier .85

BAFFLE FINISH:



RING FINISH:



LENSED TRIMS AVAILABLE IN
650L 14 WATTS | **900L** 18 WATTS | **1200L** 24 WATTS



L675W-WH - BAFFLE WITH PRISMATIC LENS (ORDERING INFORMATION) L675X- XX



Photometric Multiplier .85

BAFFLE FINISH:



RING FINISH:



LENSED TRIMS AVAILABLE IN
650L 14 WATTS | **900L** 18 WATTS | **1200L** 24 WATTS



L635W-WH - BAFFLE WITH ALBALITE LENS (ORDERING INFORMATION) L635X- XX



Photometric Multiplier .85

BAFFLE FINISH:



RING FINISH:



LENSED TRIMS AVAILABLE IN
650L 14 WATTS | **900L** 18 WATTS | **1200L** 24 WATTS



L636W-WH - BAFFLE WITH FRESNEL LENS (ORDERING INFORMATION) L636X- XX



Photometric Multiplier .85

BAFFLE FINISH:



RING FINISH:



LENSED TRIMS AVAILABLE IN
650L 14 WATTS | **900L** 18 WATTS | **1200L** 24 WATTS



B61C-LED-900L-DIM10-120-MD-40K-AT-L631-W-WH

Test no.: EL-111343

Lumens: **853**

Spacing criteria: **0.82**

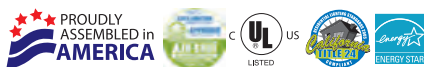

Candle Power Distribution Curve (Candela)

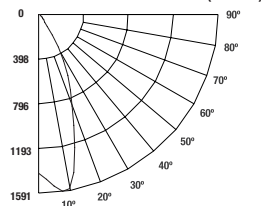

Candela Distribution

Q	Candela
0	1413
5	1446
15	1238
25	731
35	347
45	133
55	21
65	10
75	4
85	1
90	0

Zonal Lumen Summary

Zone	Lumens	%Lamp	%Fixture
0-20	435.53	51.20	51.00
0-30	685.15	80.50	80.30
0-40	784.80	92.20	92.00
0-60	840.03	98.70	98.40
0-80	851.89	100.10	99.80
0-90	853.48	100.30	100.00

6" LED L600 LENSED REFLECTOR TRIMS

L657CL-WH - REFLECTOR WITH FROSTED DOME SHOWER LENS (ORDERING INFORMATION) L657X- XX



REFLECTOR FINISH:



RING FINISH:



L659CL-WH - REFLECTOR WITH FROSTED LENS (ORDERING INFORMATION) L659X- XX

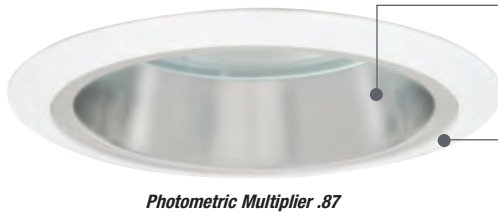

REFLECTOR FINISH:



RING FINISH:



L658CL-WH - REFLECTOR WITH PRISMATIC LENS (ORDERING INFORMATION) L658X- XX



REFLECTOR FINISH:



RING FINISH:



L641CL-WH - REFLECTOR WITH ALBALITE LENS (ORDERING INFORMATION) L641X- XX

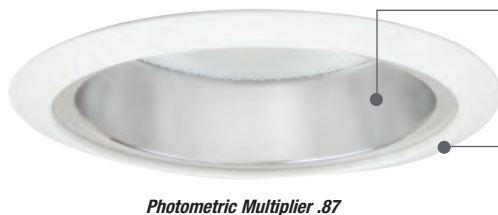

REFLECTOR FINISH:



RING FINISH:



L642CL-WH - REFLECTOR WITH FRESNEL LENS (ORDERING INFORMATION) L642X- XX



REFLECTOR FINISH:



RING FINISH:



LED
6"

6 INCH REFLECTOR LED TRIMS

LENSED TRIMS AVAILABLE IN
650L 14 WATTS | **900L** 18 WATTS | **1200L** 24 WATTS

6" LED L600 LENSED TRIMS

L652WH - SMOOTH FROSTED LENS



LENS FINISH: FROSTED (ORDERING INFORMATION) **L652XX**

RING FINISH:

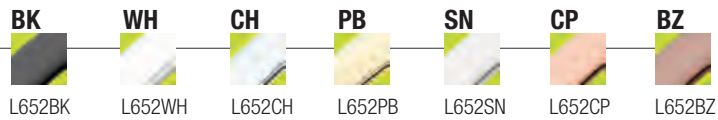

LENSED TRIMS AVAILABLE IN
650L 14 WATTS | **900L** 18 WATTS | **1200L** 24 WATTS

L612WH - SMOOTH FROSTED DOME LENS



LENS FINISH: FROSTED (ORDERING INFORMATION) **L612XX**

RING FINISH:



LENSED TRIMS AVAILABLE IN
650L 14 WATTS | **900L** 18 WATTS | **1200L** 24 WATTS

L645WH - DESIGNER POINT LENS



LENS FINISH: FROSTED (ORDERING INFORMATION) **L655XX**

RING FINISH:

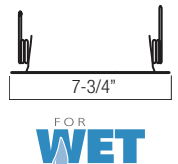
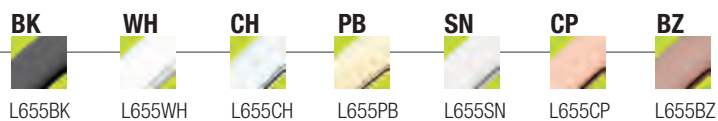

LENSED TRIMS AVAILABLE IN
650L 14 WATTS | **900L** 18 WATTS | **1200L** 24 WATTS

L601WH/L601L - METAL/PLASTIC ALBALITE LENS



LENS FINISH: ALBALITE-WHITE (ORDERING INFORMATION) **L601XX**

RING FINISH:

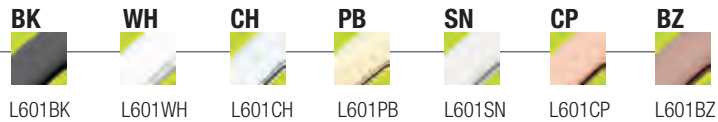

LENSED TRIMS AVAILABLE IN
650L 14 WATTS | **900L** 18 WATTS | **1200L** 24 WATTS

L605WH/L605L - METAL/PLASTIC FRESNEL LENS



LENS FINISH: FRESNEL-CLEAR (ORDERING INFORMATION) **L605XX**

RING FINISH:

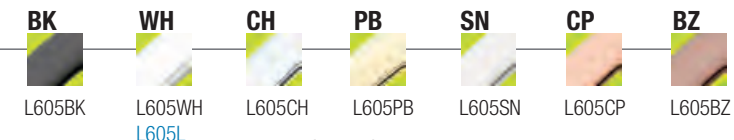

LENSED TRIMS AVAILABLE IN
650L 14 WATTS | **900L** 18 WATTS | **1200L** 24 WATTS

LED
6"

6 INCH LENSED LED TRIMS

6" LED L600 LENSED TRIMS



LED
6"

6 INCH LENSED LED TRIMS

L606WH/L606L - METAL/PLASTIC DROP OPAL LENS

LENS FINISH: DROP OPAL-FROSTED (ORDERING INFORMATION) **L606XX**

RING FINISH:



L606BK



L606WH
L606L



L606CH



L606PB



L606SN



L606CP



L606BZ

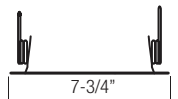

FOR
WET
LOCATION

LENSED TRIMS AVAILABLE IN
650L 900L 1200L
14 WATTS | 18 WATTS | 24 WATTS

6" LED L600 SQUARE LENSED TRIMS

LENSED TRIMS AVAILABLE ONLY IN 18W (900 LUMENS) AND 24W (1200 LUMENS)

L688WH - SQUARE ALBALITE LENS



LENS FINISH: ALBALITE-WHITE (ORDERING INFORMATION) **L688-XX**

RING FINISH:

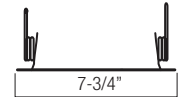

PATENT #: D510,151

LENSED TRIMS AVAILABLE IN
650L900L1200L
 14 WATTS | 18 WATTS | 24 WATTS

FOR **WET** LOCATION

L685WH - SQUARE FRESNEL LENS



LENS FINISH: FRESNEL-CLEAR (ORDERING INFORMATION) **L685-XX**

RING FINISH:

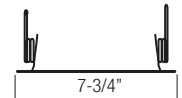
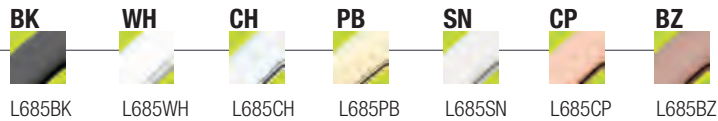

PATENT #: D510,151

LENSED TRIMS AVAILABLE IN
650L900L1200L
 14 WATTS | 18 WATTS | 24 WATTS

FOR **WET** LOCATION

L680WH - SQUARE DESIGNER POINT LENS

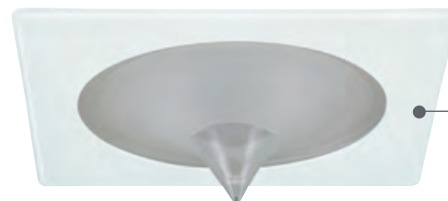

LENS FINISH: FROSTED (ORDERING INFORMATION) **L680XX**

RING FINISH:

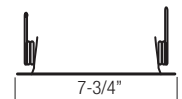
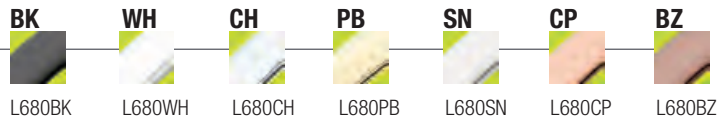

PATENT #: D510,151

LENSED TRIMS AVAILABLE IN
650L900L1200L
 14 WATTS | 18 WATTS | 24 WATTS

FOR **WET** LOCATION

L696WH - SQUARE DESIGNER FROSTED LENS



LENS FINISH: FROSTED (ORDERING INFORMATION) **L696XX**

RING FINISH:

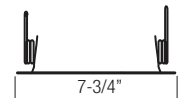
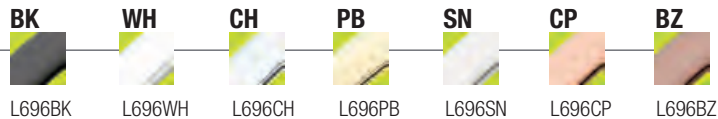

PATENT #: D510,151

LENSED TRIMS AVAILABLE IN
650L900L1200L
 14 WATTS | 18 WATTS | 24 WATTS

FOR **WET** LOCATION

LED
6"

6 INCH SQUARE LED TRIMS

6" LED L600 SQUARE LENSED TRIMS







LED

6"







6 INCH SQUARE LED TRIMS

L681BZ-WH - SQUARE BAFFLE (ORDERING INFORMATION) L681X- XX

BAFFLE FINISH:

-  **BZ**
-  **CP**
-  **SN**
-  **W**
-  **P**

RING FINISH:





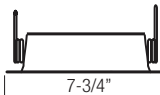

-  **BK**
-  **WH**
-  **CH**
-  **PB**
-  **SN**
-  **CP**
-  **BZ**

PATENT #: D510,151









L687CP-WH - SQUARE REFLECTOR (ORDERING INFORMATION) L687X- XX

REFLECTOR FINISH:

-  **CL**
-  **CP**
-  **MB**
-  **RG**
-  **SN**
-  **W**

RING FINISH:

-  **BK**
-  **WH**
-  **CH**
-  **PB**
-  **SN**
-  **CP**
-  **BZ**

PATENT #: D510,151

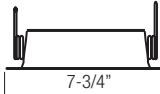

B6IC-LED 6" NEW CONSTRUCTION IC LED HOUSING



900 LUMENS **IC RATED**

INPUT VOLT.	INPUT FREQ.	INPUT CUR.	INPUT POWER	THD	POWER FACTOR	LUMENS
120/277	50/60Hz	150mA/65mA	18W(+/-5%)	<20%	>0.9	900
120/277	50/60Hz	116mA/50mA	14W(+/-5%)	<20%	>0.9	650

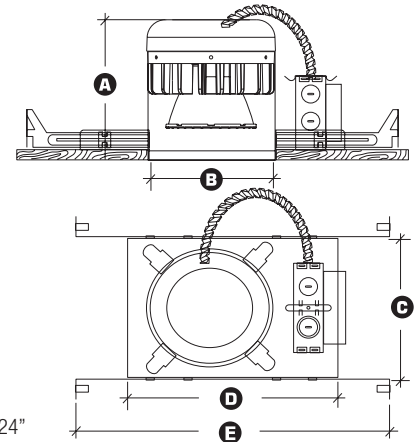

DESCRIPTION - 6" LED dedicated New Construction IC housing with integral LED heat management casting and driver (installed on junction box). Designed for new construction installations and suitable for use in insulation covered or non-insulation covered ceilings. Lighting is smooth and comfortable while using 75% less energy than the equivalent 65W BR30 & 75W BR30 and 25% less than the common 18W & 26W CFL luminaire. Plus, the eco-friendly Elite LED system features 70% lumen maintenance at 72,000 hours life, with Energy Star and California Title-24 compliances.

FEATURES - Greater light output than an 18W & 26W CFL or a 65W BR30 & 75W BR30 while consuming less than 14W & 18W of power. Elite LED luminaires are ideally suited for use in hospitality, health care, commercial, retail and residential applications.

OPTICS - Elite's optics gather the light scattered by the LED chip, shape it into a functional beam with state of the art reflectors, integrate the light through a smooth lens to minimize brightness, then top it all of with a glare reducing cone that has a 55-degree cut-off. Now you have the Elite engineered, superior quality, light engine; producing over 650 & 900 lumens.

DURABILITY - Die-cast aluminum heat management system is engineered for extremely long life and service period. Heat sink is attached to top of housing. The LED light engine is attached to the die-cast heat sink and is easily replaceable and upgradable. Life tests have shown the Elite light engine output will be maintained at 70% of initial at 50,000 hours of operation. Our LED driver is rated for 50 to 60 Hz, produces less than 20% THD, has a power factor between 0.90 and 1.00 and is thermally protected for additional safety. Elite's driver is installed on the junction box cover so it may be serviced from below the ceiling.

REPEATABLE - All Elite LED luminaries are rated at 90+ CRI as rated and tested to LM-79 and LM-80 standards by a certified laboratory. California Title 24-2013 and Energy Star compliance are standard.

DIMMABLE - The Elite LED system is fully dimmable down to 10% of initial light output with a 0-10 Volt dimmer when ordered with the following option (DIM10-MVOLT). Fixtures can be shipped with a Lutron Hi-lume A series Driver which can be dimmed with Lutron Dimming Systems when ordered with the following options (120-LUTH, 277-LUTH). Triac & Electronic Low Voltage dimming driver also available when ordered with the following options (DIMTR-120). Consult Factory for details.

HOUSING - Die-formed aluminum and galvanized steel for maximum heat dissipation and rust protection. Housing adjusts vertically in plaster frame to accommodate 1/2" to 1-3/8" thick ceiling. Housing is IC rated for direct contact with insulation and can be used in IC and NON-IC applications. May be installed in 2" x 8" joist construction.



JUNCTION BOX - UL Listed for through-branch circuit wiring, provided with four 1/2" knockouts, one 3/4" knockout and four Romex knockouts with true pry-out slots and strain clamps. Designed for straight through conduit runs. Driver is installed on the junction box cover so it may be serviced from below the ceiling.

THERMAL PROTECTION - Standard thermal protection device guards against improper installation and misuse of insulation material.

BAR HANGERS - Preinstalled bar hangers allow housing to be positioned and locked at any point within a 24" joist span. They can be positioned on either the long or short axis of the housing and can be shortened for 12" joists. They contain a double-headed real nail for secure attachment into the joist. Bar hanger nails are installed on a 20° downward angle for better contact, and the 90° pivoting mounting plate makes installation fast and accurate. Bar hangers can fit onto T-Bar spline with additional slots and holes for special mounting methods if necessary.

OUR WORD - The Elite LED lighting system carries a five-year carefree warranty for parts and components. (Labor not included.)

LISTING

c-UL-us - listed for Damp location
 c-UL-us - listed for feed Through Wiring
 c-UL-us - listed for Direct Contact With Insulation
 LM79 / LM80

Covered by U.S. Patent Numbers: D6423175S, 7717390B1, D615239S

DIMMING INFORMATION

DIMTR (Triac & Electronic Low Voltage Dimming)
 DIM10 (0-10V Dimming)
 LUTH (Lutron® Hi-lume® Dimming)

ITEM SELECTOR: Example: B6IC-LED-900L-DIM10-MVOLT-MD-30K-AT-L631-W-WH

*LENSED TRIMS AVAILABLE ONLY IN 650 LUMENS

TYPE	650L SERIES	900L SERIES	OPTICS	CCT	CRI	AIR-SHUT	EMERGENCY	TRIM	BAFFLE	REFLECTOR	TRIM/RING
B6IC-LED	<input type="checkbox"/> 650L-DIMTR-120 <input type="checkbox"/> 650L-LUTH-120 <input type="checkbox"/> 650L-LUTH-277 <input type="checkbox"/> 650L-DIM10-MVOLT	<input type="checkbox"/> 900L-DIMTR-120 <input type="checkbox"/> 900L-LUTH-120 <input type="checkbox"/> 900L-LUTH-277 <input type="checkbox"/> 900L-DIM10-MVOLT	<input type="checkbox"/> MD (Medium)	<input type="checkbox"/> 27K <input type="checkbox"/> 30K <input type="checkbox"/> 35K <input type="checkbox"/> 40K <input type="checkbox"/> 50K (85+ CRI Only)	<input type="checkbox"/> 85+ <input type="checkbox"/> 90+	<input type="checkbox"/> AT	<input type="checkbox"/> EMG	<input type="checkbox"/> L631 <input type="checkbox"/> L635* <input type="checkbox"/> L652* <input type="checkbox"/> L687* <input type="checkbox"/> L607 <input type="checkbox"/> L636* <input type="checkbox"/> L612* <input type="checkbox"/> L681* <input type="checkbox"/> L611 <input type="checkbox"/> L657* <input type="checkbox"/> L645* <input type="checkbox"/> L688* <input type="checkbox"/> L622 <input type="checkbox"/> L659* <input type="checkbox"/> L601* <input type="checkbox"/> L685* <input type="checkbox"/> L656* <input type="checkbox"/> L658* <input type="checkbox"/> L601L* <input type="checkbox"/> L680* <input type="checkbox"/> L676* <input type="checkbox"/> L641* <input type="checkbox"/> L605* <input type="checkbox"/> L689* <input type="checkbox"/> L675* <input type="checkbox"/> L642* <input type="checkbox"/> L605L* <input type="checkbox"/> L696*	<input type="checkbox"/> W <input type="checkbox"/> BZ <input type="checkbox"/> P <input type="checkbox"/> CL <input type="checkbox"/> SN <input type="checkbox"/> CP <input type="checkbox"/> BZ <input type="checkbox"/> RG <input type="checkbox"/> MB <input type="checkbox"/> MB <input type="checkbox"/> W <input type="checkbox"/> W <input type="checkbox"/> SN <input type="checkbox"/> SN <input type="checkbox"/> SHZ <input type="checkbox"/> SHZ	<input type="checkbox"/> BK <input type="checkbox"/> WH <input type="checkbox"/> CH <input type="checkbox"/> PB <input type="checkbox"/> SN <input type="checkbox"/> CP <input type="checkbox"/> BZ	



LED
6"

6 INCH NEW CONSTRUCTION IC LED HOUSING

6" LED L600 BAFFLE TRIMS

L631W-WH - PHENOLIC STEPPED BAFFLE



Photometric Multiplier 1.0

BAFFLE FINISH: W-WHITE (ORDERING INFORMATION) **L631W- XX**
RING FINISH:

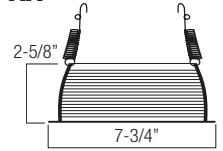
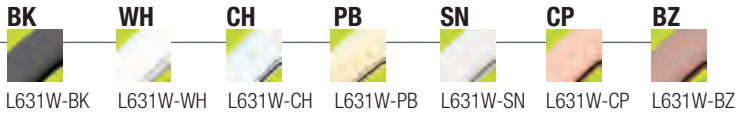

L631P-BK - PHENOLIC STEPPED BAFFLE



Photometric Multiplier .75

BAFFLE FINISH: P-BLACK (ORDERING INFORMATION) **L631P- XX**
RING FINISH:

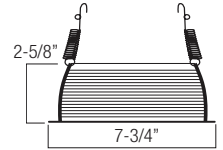
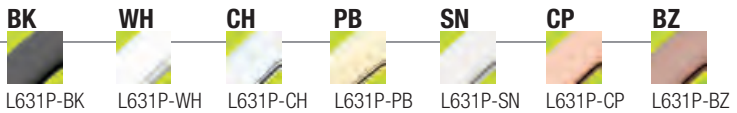

L631SN-SN - METAL STEPPED BAFFLE



Photometric Multiplier .92

BAFFLE FINISH: SN-SATIN NICKEL (ORDERING INFORMATION) **L631SN- XX**
RING FINISH:

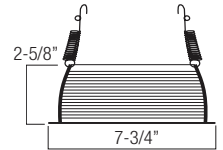
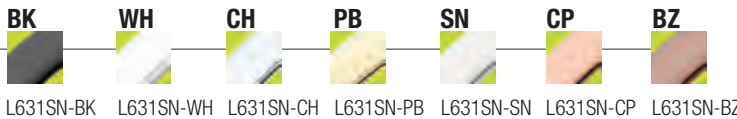

L631CP-CP - METAL STEPPED BAFFLE



Photometric Multiplier .87

BAFFLE FINISH: CP-COPPER (ORDERING INFORMATION) **L631CP- XX**
RING FINISH:

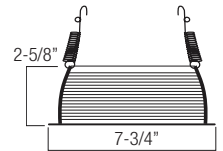
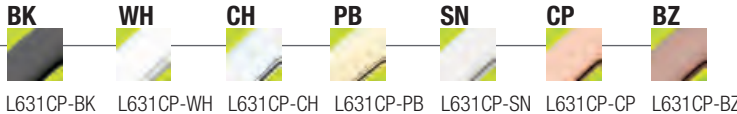

L631BZ-BZ - METAL STEPPED BAFFLE



Photometric Multiplier .85

BAFFLE FINISH: BZ-BRONZE (ORDERING INFORMATION) **L631BZ- XX**
RING FINISH:

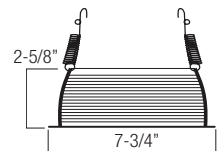

B61C-LED-650L-DIM10-120-MD-40K-AT-L631-W-WH
 TEST NO.: EL-111333
 LUMENS: 754
 SPACING CRITERIA: 0.76

Candle Power Distribution Curve (Candela)

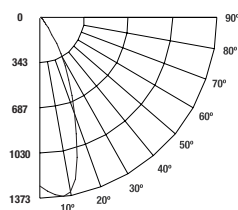

Candela Distribution

	Q
0	1282
5	1326
15	1057
25	571
35	263
45	104
55	20
65	10
75	5
85	2
90	1

Zonal Lumen Summary

Zone	Lumens	%Lamp	%Fixture
0-20	376.00	50.00	49.90
0-30	591.14	78.60	78.40
0-40	682.55	90.80	90.50
0-60	738.76	98.30	98.00
0-80	751.80	100.00	99.70
0-90	753.81	100.30	100.00



LED
6"

6 INCH BAFFLE LED TRIMS

L611W-WH - BAFFLE WALL WASH (ORDERING INFORMATION) L611X- XX-WH

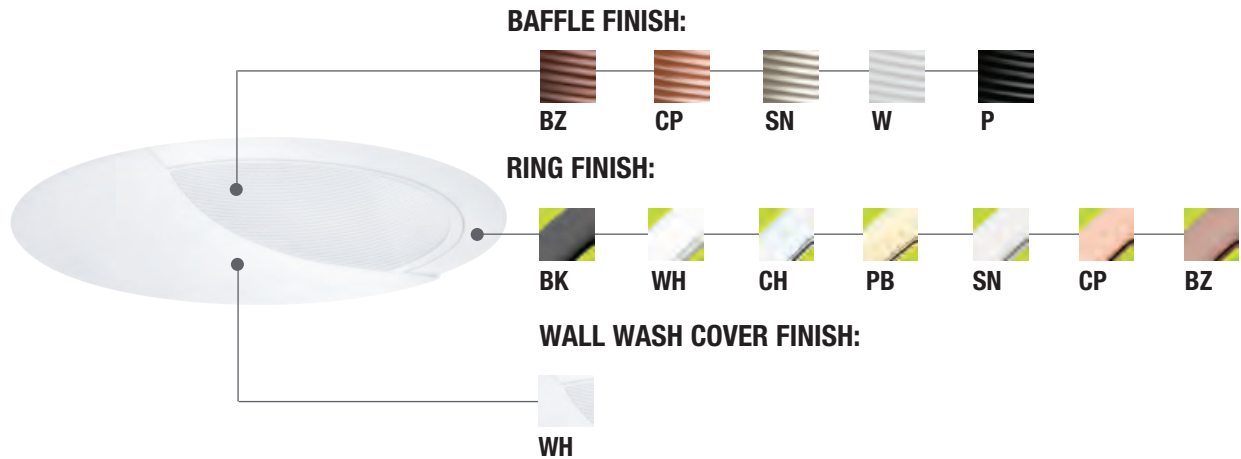

6" LED L600 REFLECTOR TRIMS

L607CL-WH - REFLECTOR



Photometric Multiplier 1.0

REFLECTOR FINISH: CL-CLEAR (ORDERING INFORMATION) **L607CL- XX**

RING FINISH:

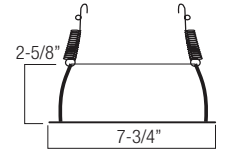
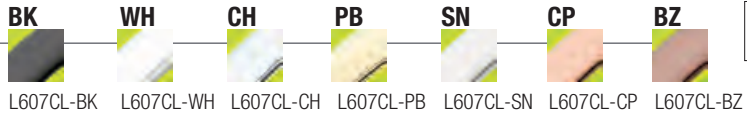

L607MB-WH - REFLECTOR



Photometric Multiplier .77

REFLECTOR FINISH: MB-BLACK (ORDERING INFORMATION) **L607MB- XX**

RING FINISH:

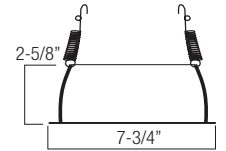

L607RG-WH - REFLECTOR



Photometric Multiplier .90

REFLECTOR FINISH: RG-GOLD (ORDERING INFORMATION) **L607RG- XX**

RING FINISH:

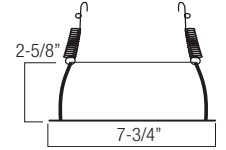

L607W-WH - REFLECTOR



Photometric Multiplier .95

REFLECTOR FINISH: W-WHITE (ORDERING INFORMATION) **L607W- XX**

RING FINISH:

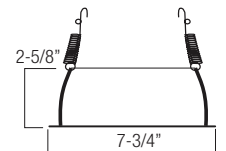
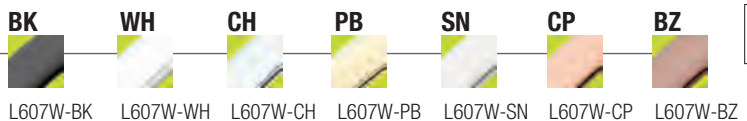

L607CP-CP - REFLECTOR



Photometric Multiplier .90

REFLECTOR FINISH: CP-COPPER (ORDERING INFORMATION) **L607CP- XX**

RING FINISH:

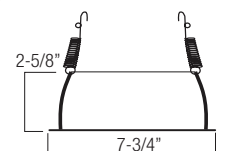
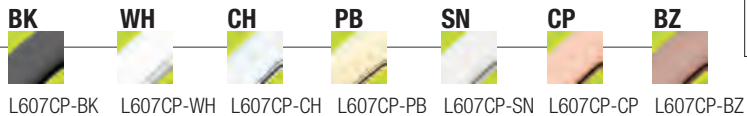

B6IC-LED-650L-DIM10-120-MD-40K-AT-L631-W-WH

Test no.: EL-111333

Lumens: 754

Spacing criteria: 0.76



Candle Power Distribution Curve (Candela)

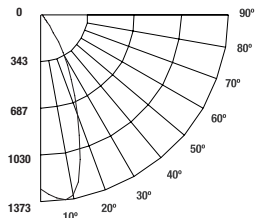

Candela Distribution

	Q
0	1282
5	1326
15	1057
25	571
35	263
45	104
55	20
65	10
75	5
85	2
90	1

Zonal Lumen Summary

Zone	Lumens	%Lamp	%Fixture
0-20	376.00	50.00	49.90
0-30	591.14	78.60	78.40
0-40	682.55	90.80	90.50
0-60	738.76	98.30	98.00
0-80	751.80	100.00	99.70
0-90	753.81	100.30	100.00

6" LED L600 REFLECTOR TRIMS

L622W-WH - REFLECTOR WALL WASH (ORDERING INFORMATION) L622X- XX-WH



REFLECTOR FINISH:



RING FINISH:



WALL WASH COVER FINISH:

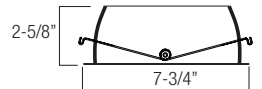

L607SN-SN - Reflector

REFLECTOR FINISH: SN-SATIN NICKEL (ORDERING INFORMATION) L607SN- XX

RING FINISH:



Photometric Multiplier .87

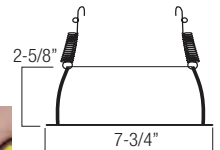
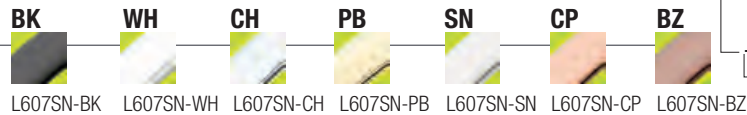

L607BZ-BZ - REFLECTOR

REFLECTOR FINISH: BZ-BRONZE (ORDERING INFORMATION) L607BZ- XX

RING FINISH:



Photometric Multiplier .87

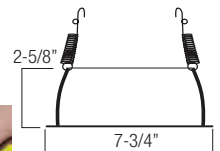
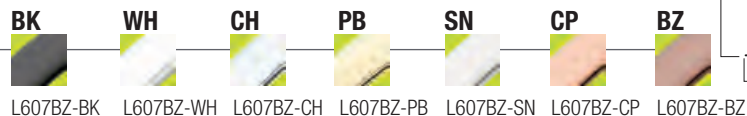

L607SHZ-WH - REFLECTOR

REFLECTOR FINISH: SHZ-SATIN HAZE (ORDERING INFORMATION) L607SHZ- XX

RING FINISH:

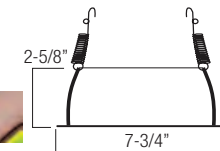
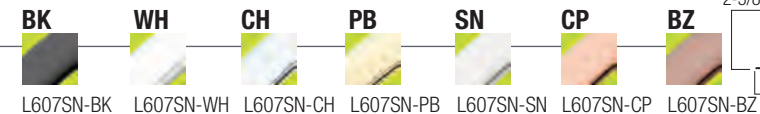

B6IC-LED-900L-DIM10-120-MD-40K-AT-L607-CL-WH

Test no.: EL-111344

Lumens: 872

Spacing criteria: 0.64



Candle Power Distribution Curve (Candela)

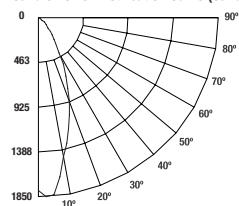

Candela Distribution

0	Q
0	1790
5	1801
15	1148
25	657
35	318
45	126
55	22
65	9
75	1
85	1
90	0

Zonal Lumen Summary

Zone	Lumens	%Lamp	%Fixture
0-20	456.67	52.50	52.30
0-30	708.95	81.50	81.30
0-40	810.37	93.20	92.90
0-60	866.26	99.60	99.30
0-80	872.08	100.30	100.00
0-90	872.44	100.30	100.00

6" LED L600 LENSED BAFFLE TRIMS

L656W-WH - BAFFLE WITH FROSTED DOME SHOWER LENS (ORDERING INFORMATION) L656X- XX

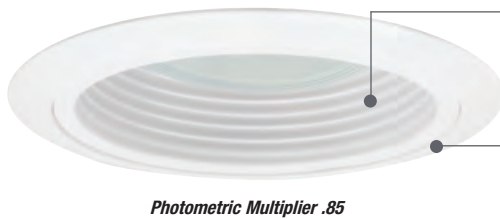

BAFFLE FINISH:



RING FINISH:



LENSED TRIMS AVAILABLE IN
650L 14 WATTS | **900L** 18 WATTS | **1200L** 24 WATTS



L676W-WH - BAFFLE WITH FROSTED LENS (ORDERING INFORMATION) L676X- XX



BAFFLE FINISH:



RING FINISH:



LENSED TRIMS AVAILABLE IN
650L 14 WATTS | **900L** 18 WATTS | **1200L** 24 WATTS



L675W-WH - BAFFLE WITH PRISMATIC LENS (ORDERING INFORMATION) L675X- XX



BAFFLE FINISH:



RING FINISH:



LENSED TRIMS AVAILABLE IN
650L 14 WATTS | **900L** 18 WATTS | **1200L** 24 WATTS



L635W-WH - BAFFLE WITH ALBALITE LENS (ORDERING INFORMATION) L635X- XX



BAFFLE FINISH:



RING FINISH:



LENSED TRIMS AVAILABLE IN
650L 14 WATTS | **900L** 18 WATTS | **1200L** 24 WATTS



L636W-WH - BAFFLE WITH FRESNEL LENS (ORDERING INFORMATION) L636X- XX



BAFFLE FINISH:



RING FINISH:



LENSED TRIMS AVAILABLE IN
650L 14 WATTS | **900L** 18 WATTS | **1200L** 24 WATTS



B61C-LED-900L-DIM10-120-MD-40K-AT-L631-W-WH

Test no.: EL-111343

Lumens: **853**

Spacing criteria: **0.82**



Candle Power Distribution Curve (Candela)

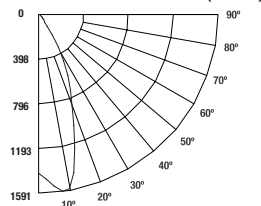

Candela Distribution

Q	Q
0	1413
5	1446
15	1238
25	731
35	347
45	133
55	21
65	10
75	4
85	1
90	0

Zonal Lumen Summary

Zone	Lumens	%Lamp	%Fixture
0-20	435.53	51.20	51.00
0-30	685.15	80.50	80.30
0-40	784.80	92.20	92.00
0-60	840.03	98.70	98.40
0-80	851.89	100.10	99.80
0-90	853.48	100.30	100.00

6" LED L600 LENSED REFLECTOR TRIMS

L657CL-WH - REFLECTOR WITH FROSTED DOME SHOWER LENS (ORDERING INFORMATION) L657X- XX



REFLECTOR FINISH:



RING FINISH:



L659CL-WH - REFLECTOR WITH FROSTED LENS (ORDERING INFORMATION) L659X- XX

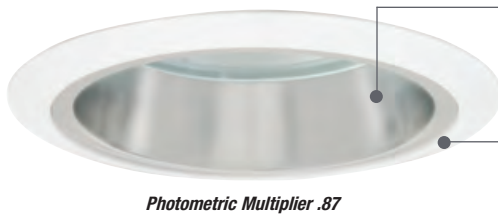

REFLECTOR FINISH:



RING FINISH:

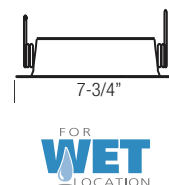

L658CL-WH - REFLECTOR WITH PRISMATIC LENS (ORDERING INFORMATION) L658X- XX



REFLECTOR FINISH:



RING FINISH:

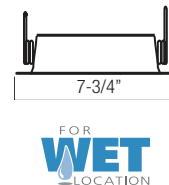

L641CL-WH - REFLECTOR WITH ALBALITE LENS (ORDERING INFORMATION) L641X- XX

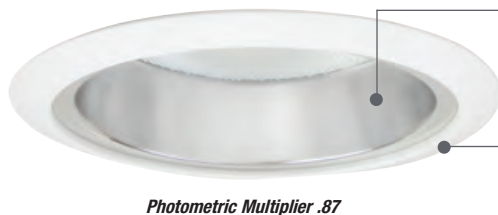

REFLECTOR FINISH:



RING FINISH:



L642CL-WH - REFLECTOR WITH FRESNEL LENS (ORDERING INFORMATION) L642X- XX



REFLECTOR FINISH:



RING FINISH:

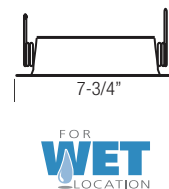

LED
6"

6 INCH REFLECTOR LED TRIMS

LENSED TRIMS AVAILABLE IN
650L 14 WATTS | **900L** 18 WATTS | **1200L** 24 WATTS

6" LED L600 LENSED TRIMS

L652WH - SMOOTH FROSTED LENS



LENS FINISH: FROSTED (ORDERING INFORMATION) **L652XX**

RING FINISH:

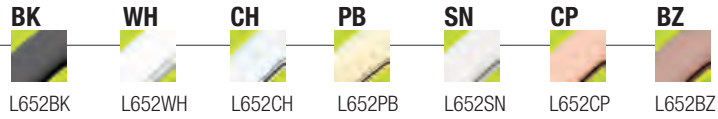

LENSED TRIMS AVAILABLE IN
650L 14 WATTS | **900L** 18 WATTS | **1200L** 24 WATTS

L612WH - SMOOTH FROSTED DOME LENS



LENS FINISH: FROSTED (ORDERING INFORMATION) **L612XX**

RING FINISH:

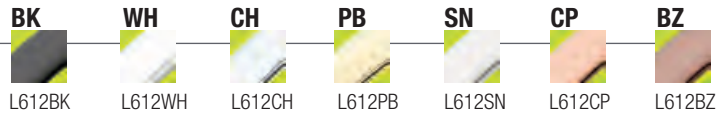

LENSED TRIMS AVAILABLE IN
650L 14 WATTS | **900L** 18 WATTS | **1200L** 24 WATTS

L645WH - DESIGNER POINT LENS



LENS FINISH: FROSTED (ORDERING INFORMATION) **L655XX**

RING FINISH:

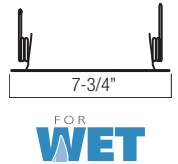
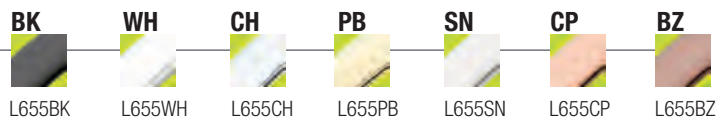

LENSED TRIMS AVAILABLE IN
650L 14 WATTS | **900L** 18 WATTS | **1200L** 24 WATTS

L601WH/L601L - METAL/PLASTIC ALBALITE LENS



LENS FINISH: ALBALITE-WHITE (ORDERING INFORMATION) **L601XX**

RING FINISH:

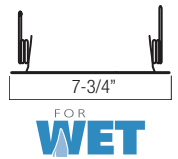
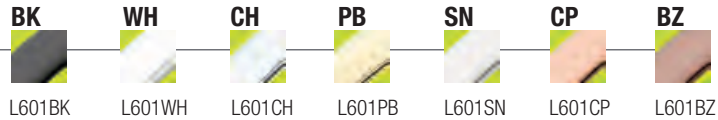

LENSED TRIMS AVAILABLE IN
650L 14 WATTS | **900L** 18 WATTS | **1200L** 24 WATTS

L605WH/L605L - METAL/PLASTIC FRESNEL LENS



LENS FINISH: FRESNEL-CLEAR (ORDERING INFORMATION) **L605XX**

RING FINISH:

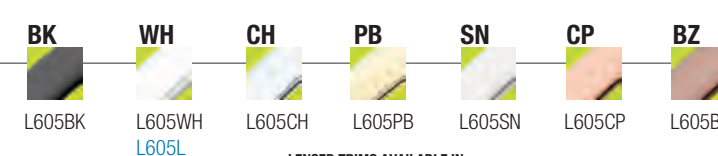

LENSED TRIMS AVAILABLE IN
650L 14 WATTS | **900L** 18 WATTS | **1200L** 24 WATTS

LED
6"

6 INCH LENSED LED TRIMS

6" LED L600 LENSED TRIMS



LED
6"







6 INCH LENSED LED TRIMS

L606WH/L606L - METAL/PLASTIC DROP OPAL LENS

LENS FINISH: DROP OPAL-FROSTED (ORDERING INFORMATION) **L606XX**

RING FINISH:



- 
BK
 L606BK
- 
WH
 L606WH
 L606L
- 
CH
 L606CH
- 
PB
 L606PB
- 
SN
 L606SN
- 
CP
 L606CP
- 
BZ
 L606BZ

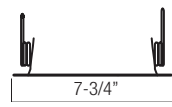

LENSED TRIMS AVAILABLE IN
650L 900L 1200L
 14 WATTS | 18 WATTS | 24 WATTS

6" LED L600 SQUARE LENSED TRIMS

LENSED TRIMS AVAILABLE ONLY IN 18W (900 LUMENS) AND 24W (1200 LUMENS)

L688WH - SQUARE ALBALITE LENS



LENS FINISH: ALBALITE-WHITE (ORDERING INFORMATION) **L688-XX**

RING FINISH:

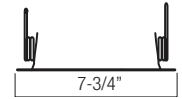

PATENT #: D510,151

LENSED TRIMS AVAILABLE IN
650L900L1200L
14 WATTS | 18 WATTS | 24 WATTS

FOR **WET** LOCATION

L685WH - SQUARE FRESNEL LENS



LENS FINISH: FRESNEL-CLEAR (ORDERING INFORMATION) **L685-XX**

RING FINISH:

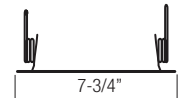
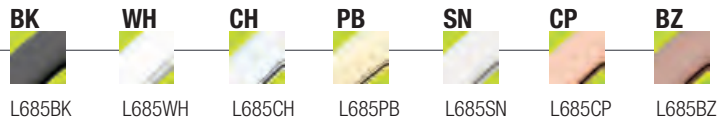

PATENT #: D510,151

LENSED TRIMS AVAILABLE IN
650L900L1200L
14 WATTS | 18 WATTS | 24 WATTS

FOR **WET** LOCATION

L680WH - SQUARE DESIGNER POINT LENS

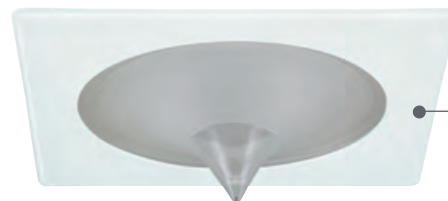

LENS FINISH: FROSTED (ORDERING INFORMATION) **L680XX**

RING FINISH:

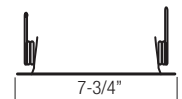
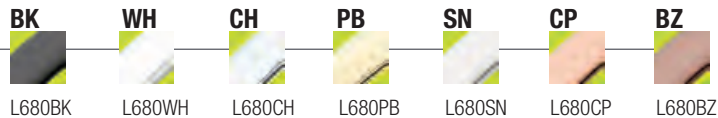

PATENT #: D510,151

LENSED TRIMS AVAILABLE IN
650L900L1200L
14 WATTS | 18 WATTS | 24 WATTS

FOR **WET** LOCATION

L696WH - SQUARE DESIGNER FROSTED LENS



LENS FINISH: FROSTED (ORDERING INFORMATION) **L696XX**

RING FINISH:

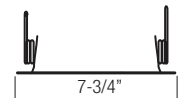
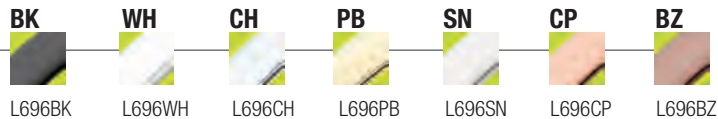

PATENT #: D510,151

LENSED TRIMS AVAILABLE IN
650L900L1200L
14 WATTS | 18 WATTS | 24 WATTS

FOR **WET** LOCATION

LED
6"

6 INCH SQUARE LED TRIMS

6" LED L600 SQUARE LENSED TRIMS



LED

6"

6 INCH SQUARE LED TRIMS

L681BZ-WH - SQUARE BAFFLE (ORDERING INFORMATION) L681X- XX

BAFFLE FINISH:

- BZ
- CP
- SN
- W
- P

RING FINISH:

- BK
- WH
- CH
- PB
- SN
- CP
- BZ

PATENT #: D510,151

L687CP-WH - SQUARE REFLECTOR (ORDERING INFORMATION) L687X- XX

REFLECTOR FINISH:

- CL
- CP
- MB
- RG
- SN
- W

RING FINISH:

- BK
- WH
- CH
- PB
- SN
- CP
- BZ

PATENT #: D510,151