

Materials

Carbon Steel

Channels made from high-quality carbon steel are continuously roll formed to precise dimensions. By cold working the steel mechanical properties are increased, allowing lightweight structures to carry the required load. Corrosion resistance of carbon steel varies widely with coating and alloy. See "Finishes" for more detailed information.

Stainless Steel

Stainless steel channel is available in AISI Type 304 or 316 material. Both are non-magnetic and belong to the austenitic stainless steels group, based on alloy content and crystallographic structure. Like carbon steel, stainless steel exhibits increased strength when cold worked by roll-forming.

Several conditions make the use of stainless steel ideal. These include reducing long term maintenance costs, high ambient temperatures, appearance, and stable structural properties such as yield strength, and high creep strength.

Type 304 resists most organic chemicals, dyestuffs and a wide variety of inorganic chemicals at elevated or cryogenic temperatures. Type 316 contains slightly more nickel and adds molybdenum to give it better corrosion resistance in chloride and sulfuric acid environments. For more information concerning the differences between types 304 and 316, visit www.bline.com.

Aluminum

Standard aluminum channel is extruded from aluminum alloy 6063-T6. Strut fittings are made from aluminum alloy 5052-H32.

The high strength to weight ratio of channel made of aluminum helps greatly reduce the overall cost of installation through ease of handling and field cutting.

Aluminum owes its excellent corrosion resistance to its ability to form an aluminum oxide film that immediately reforms when scratched or cut. In most outdoor applications, aluminum has excellent resistance to "weathering". The resistance to chemicals, indoor or outdoor, can best be determined by tests conducted by the user with exposure to the specific conditions for which it is intended. The corrosion resistance of aluminum to some commonly known chemicals is shown in the Corrosion Chart on page 10. For further information, contact us or the Aluminum Association.

Fiberglass

We offer two fire retardant (FR) resins for strut systems, polyester and vinyl ester. Both resins are ideal for corrosive environments or nonconductive applications with moderate strength requirements. Some common types of environments where Vinyl Ester Resins are recommended, that Poly Esters are not, are paper mills, most any metal plating operation and any condition with

concentrated levels of Chlorine, [Cl⁻]. Please consult our fiberglass corrosion resistance charts on page 184 for specific chemical recommendation data.

Unlike other base materials depicted in this catalog, fiberglass exhibits unique physical property changes when operating in elevated temperature conditions that are a fraction of increase compared to steel or aluminum. Thus, it is advised against using fiberglass in temperatures greater than 200° F.

Please refer to the "Corrosion Resistance Guide" on page 184 for specific applications.

The fiberglass strut systems are manufactured from glass fiber-reinforced plastic shapes that meet ASTM E-84, Class 1 Flame Rating and self-extinguishing requirements of ASTM D-635. A surface veil is applied during pultrusion to insure a resin-rich surface and ultraviolet resistance.

While polyester is sufficient for most uses, vinyl ester is suitable for a broader range of environments.

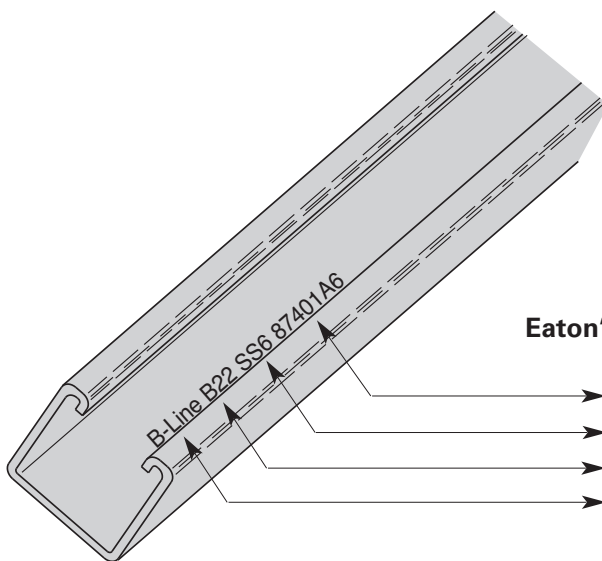

Eaton's B-Line Series Steel Strut is stamped with:

- Traceable to the steel's origin
- Material/Finish
- Part number designation
- Company Name

Finishes

Zinc Coatings

Zinc protects steel in two ways. First it protects the steel as a coating, and second acts as a sacrificial anode to repair bare areas such as cut edges, scratches, and gouges. The corrosion protection of zinc is directly related to its thickness and the environment. This means a .2 mil coating will last twice as long as a .1 mil coating in the same environment.

Galvanizing also protects cut and drilled edges.

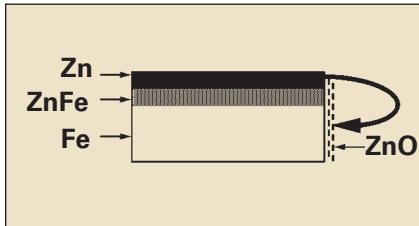

Electrogalvanized Zinc

Electrogalvanized Zinc (also known as zinc plated or electroplated) is the process by which a coating of zinc is deposited on the steel by electrolysis from a bath of zinc salts.

A rating of SC3, our standard, provides a minimum zinc coating thickness of .5 mils (excluding hardware, which is SC1 = .2 mils).

When exposed to air and moisture, zinc forms a tough, adherent, protective film consisting of a mixture of zinc oxides, hydroxides, and carbonates. This film is a barrier coating which helps slow subsequent corrosive attack on the zinc. This coating is usually recommended for indoor use in relatively dry areas, as it provides ninety-six hours protection in salt spray testing per ASTM B117.

Chromium / Zinc

Chromium / Zinc is a corrosion resistant composition, which was developed to protect fasteners and small bulk items for automotive use. The coating applications have since been extended to larger parts and other markets.

Chromium/Zinc composition is an aqueous coating dispersion containing chromium, proprietary organics, and zinc flake.

This finish provides 720 hours protection in salt spray testing per ASTM B117.

Pre-Galvanized Zinc

(Mill galvanized, hot dip mill galvanized or continuous hot dip galvanized) Pre-galvanized steel is produced by coating coils of sheet steel with zinc by continuously rolling the material through molten zinc at the mills. This is also known as mill galvanized or hot dip mill galvanized. These coils are then slit to size and fabricated by roll forming, shearing, punching, or forming to produce our pre-galvanized strut products.

The G90 specification calls for a coating of .90 ounces of zinc per square foot of steel. This results in a coating of .45 ounces per square foot on each side of the sheet. This is important when comparing this finish to hot dip galvanized after fabrication.

During fabrication, cut edges and welded areas are not normally zinc coated; however, the zinc near the uncoated metal becomes a sacrificial anode to protect the bare areas after a short period of time.

Hot Dip Galvanized After Fabrication (Hot dip galvanized or batch hot dip galvanized)

Hot dip galvanized strut products are fabricated from steel and then completely immersed in a bath of molten zinc. A metallic bond occurs resulting in a zinc coating that completely coats all surfaces, including edges and welds.

Another advantage of this method is coating thickness. Strut products that are hot dip galvanized after fabrication have a minimum thickness of 1.50 ounces per square foot on each side, or a total 3.0 ounces per square foot of steel, according to ASTM A123.

The zinc thickness is controlled by the amount of time each part is immersed in the molten zinc bath as well as the speed at which it is removed. The term "double dipping" refers to parts too large to fit into the galvanizing kettle and must be dipped one end at a time. It does not refer to extra coating thickness.

The layer of zinc which bonds to steel provides a dual protection against corrosion. It protects first as an overall barrier coating. If this coating happens to be scratched or gouged, zinc's secondary defense is called upon to protect the steel by galvanic action.

Hot-Dip Galvanized After Fabrication is recommended for prolonged outdoor exposure and will usually protect steel for 20 years or more in most atmospheric environments and in many industrial environments. For best results, a zinc rich paint (available from Eaton's B-Line Division) should be applied to field cuts. The zinc rich paint will provide immediate protection for these areas and eliminate the short time period for galvanic action to "heal" the damaged coating.

Anticipated Life of Zinc Coatings In Various Atmospheric Environments

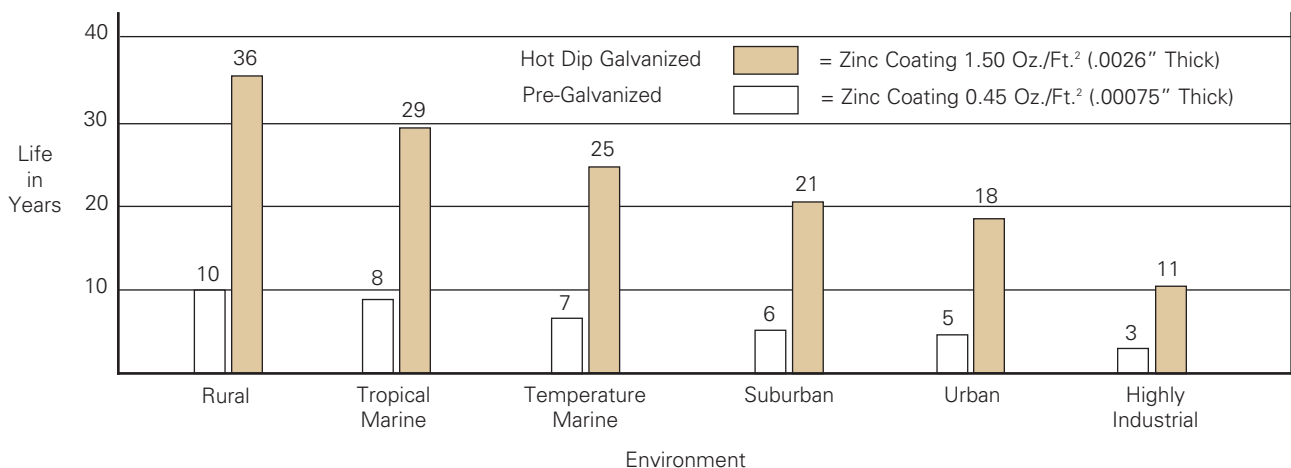

Technical Data

DURA GREEN™ and DURA-COPPER™ Epoxy Coatings

DURA GREEN and DURA-COPPER epoxy coatings are water borne epoxy coatings applied to B-Line series products by a precisely controlled cathodic electro-deposition process. This process is accomplished using a conveyor to transport channel and fittings through several cleaning, phosphatizing and application stages prior to being baked (See diagram below).

This custom-designed paint system is used for painting all channels, channel combinations, slotted angle, and fittings.

Samples are selected on a routine basis for salt spray (fog) testing to verify the quality of the finish. These tests are performed in accordance with ASTM B117 and evaluated and related according to ASTM D1654 (Tables 1 & 2).

The DURA GREEN and DURA-COPPER epoxy coatings have been tested and listed by Underwriters Laboratories in

accordance with "Standard for Surface Metal Raceway and Fittings, UL5" and "Standard for Pipe Hanger Equipment for Fire Protection Service, UL203".

Due to DURA GREEN's organically based composition, it seats itself into porous surfaces more completely and efficiently than zinc coatings. As these porous caverns are filled along the material profile, the outer finished surface demonstrates an increased smooth uniform plane which produces considerably less off-gasing when tested.

DURA GREEN channel meets or exceeds 100 level clean room standards. This was confirmed by testing the channel in accordance with Boeing (PCL) Standards, which are more stringent and complete than ASTM E595-93. DURA GREEN was found to be a superior finish, due in part to its proven application process.

Technical Data

Salt Spray Test Results

Type of Finish	Unscribed 5% Failure (1)	Scribed 1/8" (3.2) Creepage from Scribe (1)
DURA GREEN Epoxy	1000 Hours	312 Hours
Mill Galv. (Pre-Galv.) G90	192 Hours	288 Hours
Perma-Green	438 Hours	231 Hours
Zinc Chromate	36 Hours	96 Hours
Industry Green (Range)	10 to 36 Hours	4 to 30 Hours

(1) All salt spray (fog) tests conducted in accordance with ASTM B117 and evaluated and rated according to ASTM D1654 Tables 1 & 2. Tests are performed and certified by an independent testing laboratory.

DURA GREEN / DURA-COPPER Epoxy Coating Process

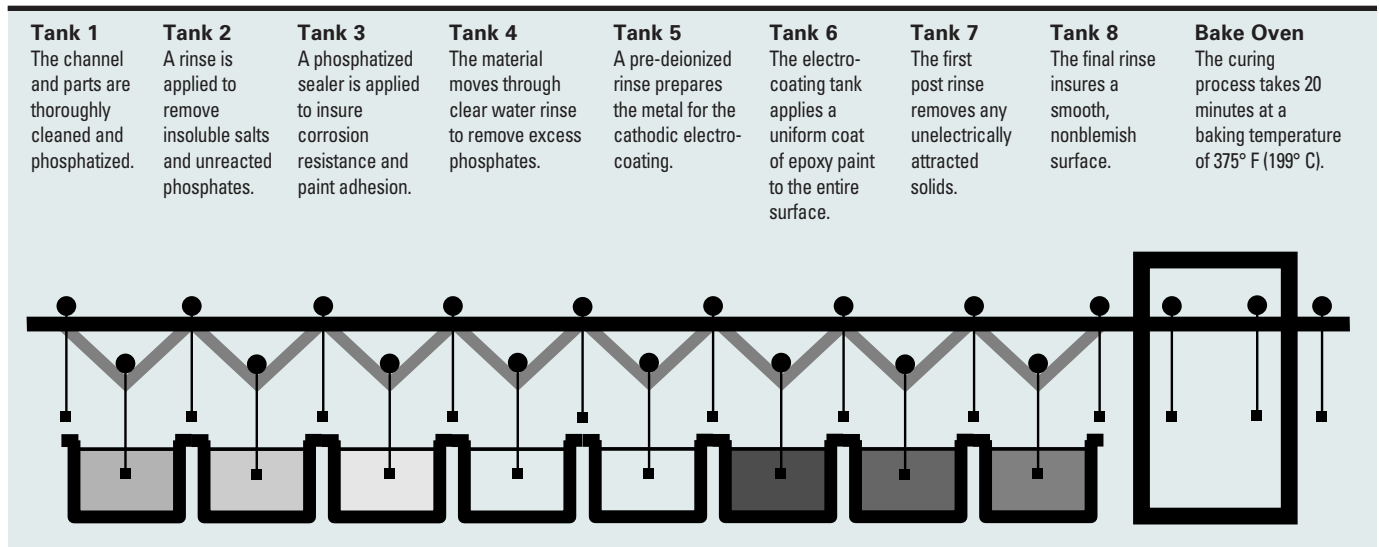

Metal Framing Channels

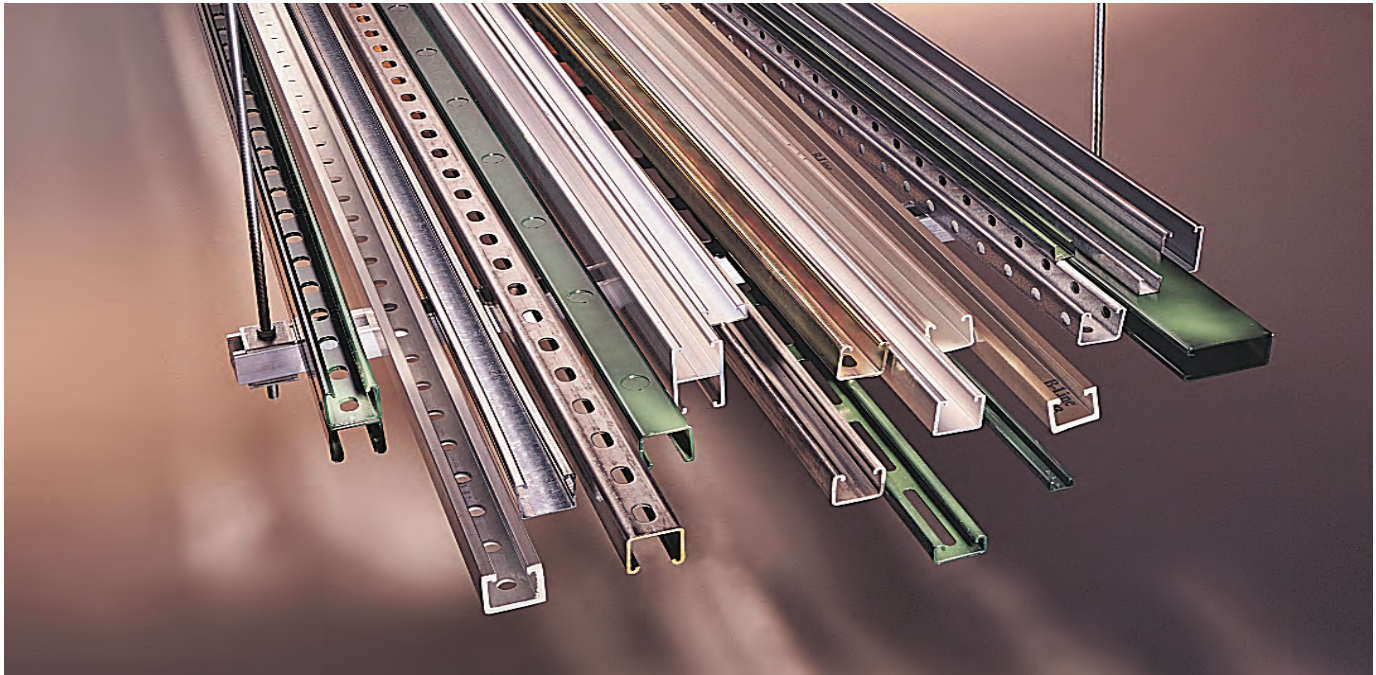

Channel

Metal framing channel is cold formed on our modern rolling mills from 12 Ga. (2.6mm), 14 Ga. (1.9mm), and 16 Ga. (1.5mm) low carbon steel strips. A continuous slot with inturned lips provides the ability to make attachments at any point.

Lengths & Tolerances

All channels excluding 'SH' style $\pm 1/8"$ (3.2mm) on 10' (3.05m) and $\pm 3/16"$ (4.76mm) on 20' (6.09m)

All 'SH' channels only $\pm 1/4"$ (6.35mm) on 10' (3.05m) and $\pm 1/2"$ (12.70mm) on 20' (6.09m)

Custom lengths are available upon request.

Slots

Slotted series of channels offer full flexibility. A variety of pre-punched slot patterns eliminate the need for precise field measuring for hole locations. Slots offer wide adjustments in the alignment and bolt sizing.

Holes

A variety of pre-punched $9/16"$ (14.3 mm) diameter hole patterns are available in our channels. These hole patterns provide an economical alternative to costly field drilling required for many applications.

Knockouts

When used with series B217-20 Closure Strips, knockout channels can be used to provide an economical U.L. listed surface raceway. Channels are furnished with $7/8"$ (22.2 mm) knockouts on 6" (152 mm) centers, allowing for perfect fixture alignment on spans up to 20' (6.09 m).

Materials & Finishes (Unless otherwise noted)

Steel: Plain & Pre-galvanized

12 Ga. (2.6), 14 Ga. (1.9) and 16 Ga. (1.5)

Note: A minimum order may apply on special material and finishes.

Design Load (Steel & Stainless Steel)

The design loads given for strut beam loads are based on a simple beam condition using an allowable stress of 25,000 psi. This allowable stress results in a safety factor of 1.68. This is based upon virgin steel minimum yield strength of 33,000 psi cold worked during rolling to an average yield stress of 42,000 psi. For aluminum channel loading multiply steel loading by a factor of 0.38.

Welding







Weld spacing is maintained between 2 $1/2$ inches (63.5 mm) and 4 inches (101.6 mm) on center. Through high quality control testing of welded channels and continuous monitoring of welding equipment, we provide the most consistent combination channels available today.

Metric

Metric dimensions are shown in parentheses. Unless noted, all metric dimensions are in millimeters.

Finish Code	Finish	Specification
PLN	Plain	ASTM A1011, 33,000 PSI min. yield
GRN	DURA GREEN™	
GLV	Pre-Galvanized	ASTM A653 33,000 PSI min. yield
HDG	Hot-Dipped Galvanized	ASTM A123
YZN	Yellow Zinc Chromate	ASTM B633 SC3 Type II
SS4	Stainless Steel Type 304	ASTM A240
SS6	Stainless Steel Type 316	ASTM A240
AL	Aluminum	Aluminum 6063-T6

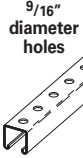
Selection Chart for Channels, Materials and Hole Patterns

Channel Type	Channel Dimensions		Material & Thickness * Stainless Steel				Channel Hole Pattern **				
	Height 	Width 	Steel	Alum.	Type 304	Type 316	SH	S	H17/8	TH	KO6
			1	2	3	4					
B11	3 1/4" (82.5)	1 5/8" (41.3)	12 Ga.	.105	–	–	1	1	1	–	1
B12	2 7/16" (61.9)	1 5/8" (41.3)	12 Ga.	.105	–	–	1 2	1	1 2	–	1 2
B22	1 5/8" (41.3)	1 5/8" (41.3)	12 Ga.	.105	12 Ga.	12 Ga.	1 2 3 4	1 3	1 2 3 4	1	1 2
B24	1 5/8" (41.3)	1 5/8" (41.3)	14 Ga.	.080	14 Ga.	14 Ga.	1 2 3 4	1	1 2 3 4	–	1 2
B26	1 5/8" (41.3)	1 5/8" (41.3)	16 Ga.	–	–	–	1	1	1	–	1
B32	1 3/8" (34.9)	1 5/8" (41.3)	12 Ga.	–	12 Ga.	–	1 3	1	1 3	–	1
B42	1" (25.4)	1 5/8" (41.3)	12 Ga.	–	12 Ga.	–	1 3	1	1 3	–	1
B52	1 3/16" (20.6)	1 5/8" (41.3)	12 Ga.	–	12 Ga.	12 Ga.	1 3 4	1	1	–	1
B54	1 3/16" (20.6)	1 5/8" (41.3)	14 Ga.	.080	14 Ga.	14 Ga.	1 2 3 4	1	1 2 3 4	–	1 2
B56	1 3/16" (20.6)	1 5/8" (41.3)	16 Ga.	–	–	–	1	1	1	–	1
B62	1 3/16" (20.6)	1 3/16" (20.6)	18 Ga.	–	–	–	–	–	–	–	–
B72	1 3/32" (10.3)	1 3/16" (20.6)	18 Ga.	–	–	–	–	–	–	–	–

The selection has been prepared to provide a reference for available channel, materials and hole patterns. Material types available for various hole patterns are defined by numbers 1 thru 4. Some stainless steel channels with hole patterns are available on special order only.

*Metric equivalent for thicknesses shown in chart. ** 1 - Steel
 12 Ga. = 2.6 mm 18 Ga. = 1.2 mm 2 - Aluminum
 14 Ga. = 1.9 mm .105 = 2.6 mm 3 - Type 304 Stainless Steel
 16 Ga. = 1.5 mm .080 = 2.0 mm 4 - Type 316 Stainless Steel

Properties may vary due to commercial tolerances of the material.

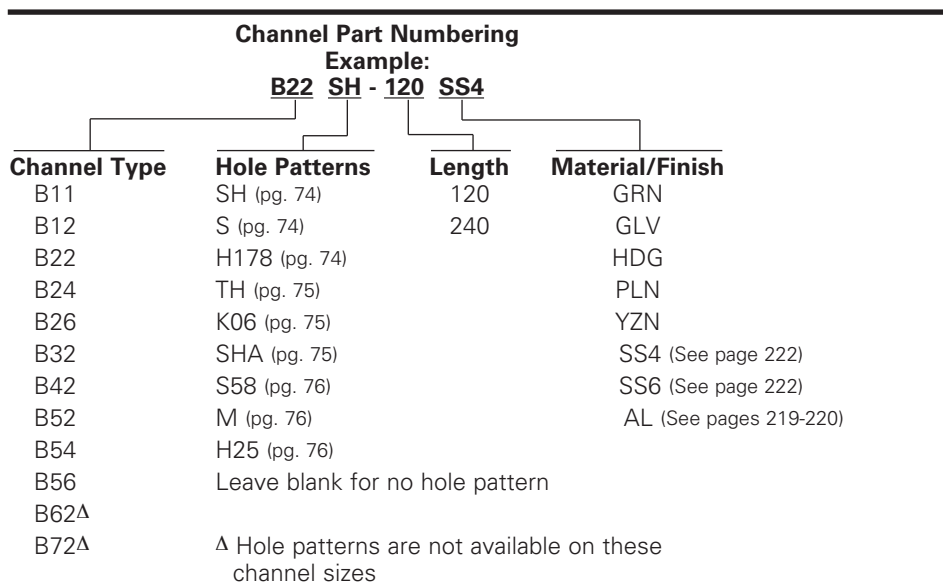

Reference page 48 for general fitting and standard finish specifications.

B22 Channel

B22

- Thickness: 12 Gauge (2.6 mm)
- Standard lengths: 10' (3.05 m) & 20' (6.09 m)
- Standard finishes: Plain, DURA GREEN™, Pre-Galvanized, Hot-Dipped Galvanized, Stainless Steel Type 304 or 316, Aluminum
- Weight: 1.90 Lbs./Ft. (2.83 kg/m)

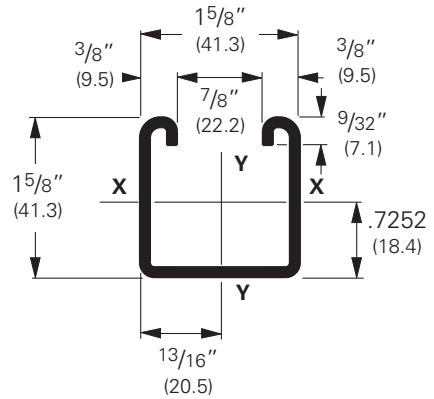
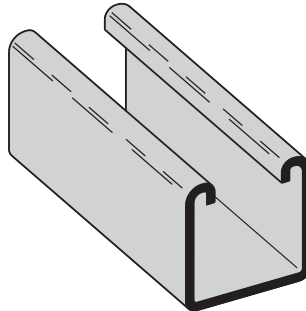

Note:

Aluminum loading, for B22 & B22A, can be determined by multiplying load data times a factor of 0.38

Section Properties			X - X Axis				Y - Y Axis									
Channel	Weight		Areas of Section		Moment of Inertia (I)		Section Modulus (S)		Radius of Gyration (r)		Moment of Inertia (I)		Section Modulus (S)		Radius of Gyration (r)	
	lbs./ft.	kg/m	sq. in.	cm ²	in. ⁴	cm ⁴	in. ³	cm ³	in.	cm	in. ⁴	cm ⁴	in. ³	cm ³	in.	cm
B22	1.910	(2.84)	.562	(3.62)	.1912	(7.96)	.2125	(3.48)	.583	(1.48)	.2399	(9.99)	.2953	(4.84)	.653	(1.66)
B22A	3.820	(5.69)	1.124	(7.25)	.9732	(40.51)	.5989	(9.81)	.931	(2.36)	.4798	(19.97)	.5905	(9.68)	.653	(1.66)
B22X	6.649	(9.89)	1.956	(12.62)	4.1484	(172.67)	1.7019	(27.89)	1.456	(3.70)	1.1023	(45.88)	1.2027	(19.71)	.751	(1.91)

Calculations of section properties are based on metal thicknesses as determined by the AISI Cold-Formed Steel Design Manual.

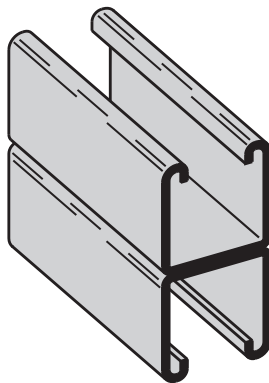

B22A

Wt. 3.80 Lbs./Ft. (5.65 kg/m)

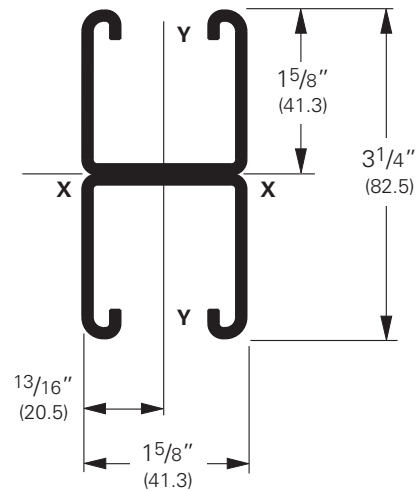

Reference page 48 for general fitting and standard finish specifications.

B22 Beam Loading Data

Beam Loading

Beam Span In. mm		Channel Style	Uniform Load and Deflection				Uniform Load @ Deflection =			
			Lbs.		kN		1/240 Span		1/360 Span	
			Lbs.	kN	In.	mm	Lbs.	kN	Lbs.	kN
12	(305)	B22	2610	(11.61)	.014	(.35)	2610	(11.61)	2610	(11.61)
		B22A	2610*	(11.61)	.002	(.05)	2610*	(11.61)	2610*	(11.61)
		B22X	5790*	(25.75)	.001	(.02)	5790*	(25.75)	5790*	(25.75)
18	(457)	B22	2269	(10.09)	.031	(.79)	2269	(10.09)	2269	(10.09)
		B22A	2610*	(11.61)	.007	(.18)	2610*	(11.61)	2610*	(11.61)
		B22X	5790*	(25.75)	.003	(.07)	5790*	(25.75)	5790*	(25.75)
24	(609)	B22	1702	(7.57)	.056	(1.42)	1702	(7.57)	1702	(7.57)
		B22A	2610*	(11.61)	.017	(.43)	2610*	(11.61)	2610*	(11.61)
		B22X	5790*	(25.75)	.008	(.20)	5790*	(25.75)	5790*	(25.75)
30	(762)	B22	1361	(6.05)	.087	(2.21)	1361	(6.05)	1294	(5.75)
		B22A	2610*	(11.61)	.033	(.84)	2610*	(11.61)	2610*	(11.61)
		B22X	5790*	(25.75)	.017	(.73)	5790*	(25.75)	5790*	(25.75)
36	(914)	B22	1135	(5.05)	.126	(3.20)	1135	(5.05)	899	(4.00)
		B22A	2610*	(11.61)	.057	(1.45)	2610*	(11.61)	2610*	(11.61)
		B22X	5790*	(25.75)	.029	(.73)	5790*	(25.75)	5790*	(25.75)
42	(1067)	B22	972	(4.32)	.172	(4.37)	972	(4.32)	660	(2.93)
		B22A	2610*	(11.61)	.091	(2.31)	2610*	(11.61)	2610*	(11.61)
		B22X	5790*	(25.75)	.046	(1.17)	5790*	(25.75)	5790*	(25.75)
48	(1219)	B22	851	(3.78)	.224	(5.69)	758	(3.37)	505	(2.24)
		B22A	2405	(10.70)	.125	(3.17)	2405	(10.70)	2405	(10.70)
		B22X	5790*	(25.75)	.068	(1.73)	5790*	(25.75)	5790*	(25.75)
54	(1371)	B22	756	(3.36)	.284	(7.21)	599	(2.66)	399	(1.77)
		B22A	2138	(9.51)	.158	(4.01)	2138	(9.51)	2024	(9.00)
		B22X	5790*	(25.75)	.097	(2.46)	5790*	(25.75)	5790*	(25.75)
60	(1524)	B22	681	(3.03)	.351	(8.91)	485	(2.16)	323	(1.44)
		B22A	1924	(8.56)	.195	(4.95)	1924	(8.56)	1640	(7.29)
		B22X	5645	(25.11)	.130	(3.30)	5645	(25.11)	5645	(25.11)
66	(1676)	B22	619	(2.75)	.424	(10.77)	401	(1.78)	267	(1.19)
		B22A	1749	(7.78)	.236	(5.99)	1749	(7.78)	1355	(6.03)
		B22X	5132	(22.83)	.158	(4.01)	5132	(22.83)	5132	(22.83)
72	(1829)	B22	567	(2.52)	.505	(12.83)	337	(1.50)	225	(1.00)
		B22A	1603	(7.13)	.281	(7.14)	1603	(7.13)	1139	(5.06)
		B22X	4704	(20.92)	.188	(4.77)	4704	(20.92)	4704	(20.92)
78	(1981)	B22	524	(2.33)	.593	(15.06)	287	(1.27)	191	(0.85)
		B22A	1480	(6.58)	.330	(8.38)	1455	(6.47)	970	(4.31)
		B22X	4342	(19.31)	.220	(5.59)	4342	(19.31)	4270	(18.99)
84	(2133)	B22	486	(2.16)	.687	(17.45)	248	(1.10)	165	(0.73)
		B22A	1374	(6.11)	.383	(9.73)	1255	(5.58)	837	(3.72)
		B22X	4032	(17.93)	.255	(6.48)	4032	(17.93)	3682	(16.38)
90	(2286)	B22	454	(2.02)	.789	(20.04)	216	(0.96)	144	(0.64)
		B22A	1283	(5.71)	.440	(11.17)	1093	(4.86)	729	(3.24)
		B22X	3763	(16.74)	.293	(7.44)	3763	(16.74)	3207	(14.26)
96	(2438)	B22	425	(1.89)	.898	(22.81)	190	(0.84)	126	(0.56)
		B22A	1202	(5.35)	.500	(12.70)	961	(4.27)	640	(2.85)
		B22X	3528	(15.69)	.334	(8.48)	3528	(15.69)	2819	(12.54)
102	(2591)	B22	400	(1.78)	1.013	(25.73)	168	(0.75)	112	(0.50)
		B22A	1132	(5.03)	.565	(14.35)	851	(3.78)	567	(2.52)
		B22X	3320	(14.77)	.377	(9.57)	3320	(14.77)	2497	(11.11)
108	(2743)	B22	378	(1.68)	1.136	(28.85)	150	(0.67)	100	(0.44)
		B22A	1069	(4.75)	.633	(16.08)	759	(3.37)	506	(2.25)
		B22X	3136	(13.95)	.422	(10.72)	3136	(13.95)	2227	(9.90)
114	(2895)	B22	358	(1.59)	1.266	(32.15)	134	(0.59)	90	(0.40)
		B22A	1013	(4.50)	.706	(17.93)	681	(3.03)	454	(2.02)
		B22X	2971	(13.21)	.471	(11.96)	2971	(13.21)	1999	(8.89)
120	(3048)	B22	340	(1.51)	1.403	(35.63)	121	(0.54)	81	(0.36)
		B22A	962	(4.28)	.782	(19.86)	615	(2.73)	410	(1.82)
		B22X	2822	(12.55)	.521	(13.23)	2706	(12.04)	1804	(8.02)

Based on simple beam condition using an allowable design stress of 25,000 psi (172 MPa) in accordance with MFMA, with adequate lateral bracing (see page 12 for further explanation). Actual yield point of cold rolled steel is 42,000 psi. To determine concentrated load capacity at mid span, multiply uniform load by 0.5 and corresponding deflection by 0.8. *Failure determined by weld shear.

Reference page 48 for general fitting and standard finish specifications.

B22 Column Loading Data

Column Loading

Unbraced Height		Channel Style	Max. Column Loading K = .80				Max. Column Loading (Loaded @ C.G.)					
			Loaded@ C.G.		Loaded@ Slot Face		K = .65		K = 1.0		K = 1.2	
In.	mm		Lbs.	kN	Lbs.	kN	Lbs.	kN	Lbs.	kN	Lbs.	kN
12	(305)	B22	10454	(46.50)	4276	(19.12)	10598	(47.14)	10222	(45.47)	9950	(44.26)
		B22A	21625	(96.19)	7002	(31.14)	21677	(96.42)	21539	(95.81)	21433	(95.34)
		B22X	46948	(208.83)	18975	(84.40)	47061	(209.34)	46761	(208.00)	46531	(206.98)
18	(457)	B22	9950	(44.26)	4153	(18.47)	10253	(45.62)	9481	(42.17)	8955	(39.83)
		B22A	21433	(95.34)	6959	(30.95)	21551	(95.86)	21239	(94.47)	21001	(93.42)
		B22X	46531	(206.98)	18859	(83.90)	46787	(208.12)	46110	(205.11)	45593	(202.81)
24	(609)	B22	9311	(41.42)	3993	(17.76)	9801	(43.60)	8582	(38.17)	7801	(34.70)
		B22A	21164	(94.14)	6898	(30.68)	21373	(95.07)	20819	(92.61)	20397	(90.73)
		B22X	45947	(204.38)	18693	(84.44)	46401	(206.40)	45198	(201.05)	44282	(196.97)
30	(762)	B22	8582	(38.17)	3802	(16.91)	9268	(41.22)	7601	(33.81)	6595	(29.33)
		B22A	20819	(92.61)	6821	(30.34)	21145	(94.06)	20279	(90.20)	19619	(87.27)
		B22X	45198	(201.05)	18485	(82.22)	45906	(204.20)	44026	(195.84)	42593	(189.46)
36	(914)	B22	7801	(34.70)	3589	(15.96)	8676	(38.59)	6595	(28.33)	5392	(23.98)
		B22A	20397	(90.73)	6728	(29.93)	20866	(92.81)	19619	(87.27)	18669	(83.04)
		B22X	44282	(196.97)	18233	(81.10)	45300	(201.50)	42593	(189.46)	40530	(180.28)
42	(1067)	B22	6998	(31.13)	3360	(14.94)	8048	(35.80)	5595	(24.89)	4444	(19.77)
		B22A	19898	(88.51)	6620	(29.45)	20537	(91.33)	18840	(83.80)	17546	(78.05)
		B22X	43198	(192.15)	17940	(79.80)	44586	(198.33)	40901	(181.94)	38092	(169.44)
48	(1219)	B22	6193	(27.55)	3118	(13.87)	7401	(32.92)	4718	(20.99)	3791	(16.86)
		B22A	19322	(85.95)	6496	(28.89)	20157	(89.66)	17940	(79.80)	16251	(72.29)
		B22X	41948	(186.59)	17604	(78.30)	43761	(194.57)	38948	(173.25)	35281	(156.94)
54	(1371)	B22	5392	(23.98)	2864	(12.74)	6746	(30.01)	4090	(18.19)	3310	(14.72)
		B22A	18669	(83.04)	6263	(27.86)	19276	(87.74)	16920	(75.26)	14782	(65.75)
		B22X	40530	(180.28)	16973	(75.50)	42825	(190.49)	36733	(163.39)	32092	(142.75)
60	(1524)	B22	4718	(20.99)	2631	(11.70)	6093	(27.10)	3616	(16.08)	2936	(13.06)
		B22A	17940	(79.80)	5340	(23.75)	19244	(85.60)	15781	(70.20)	13141	(58.45)
		B22X	38948	(173.25)	14471	(64.37)	41779	(185.84)	34260	(152.39)	28529	(126.90)
66	(1676)	B22	4202	(18.69)	2434	(10.83)	5441	(24.20)	3242	(14.42)	2634	(11.71)
		B22A	17134	(76.21)	4587	(20.40)	18712	(83.23)	14521	(64.59)	11328	(50.39)
		B22X	37198	(165.46)	12431	(55.29)	40624	(180.70)	31525	(140.23)	24593	(109.39)
72	(1829)	B22	3791	(16.86)	2264	(10.07)	4869	(21.66)	2936	(13.06)	2381	(10.59)
		B22A	16251	(72.29)	3968	(17.65)	18129	(80.64)	13141	(58.45)	9524	(42.36)
		B22X	35281	(156.94)	10753	(47.83)	39358	(175.07)	28529	(126.90)	20676	(91.97)
78	(1981)	B22	3456	(15.37)	2116	(9.41)	4412	(19.62)	2680	(11.92)	2166	(9.63)
		B22A	15291	(68.02)	3456	(15.37)	17496	(77.82)	11642	(51.78)	8115	(36.10)
		B22X	33197	(147.67)	9366	(41.66)	37984	(168.96)	25275	(112.43)	17617	(78.36)
84	(2133)	B22	3176	(14.13)	1984	(8.82)	4037	(17.96)	2461	(10.95)	1980	(8.81)
		B22A	14255	(63.41)	3028	(13.47)	16812	(74.78)	10076	(44.82)	6998	(31.13)
		B22X	30947	(137.66)	8206	(36.50)	36499	(162.35)	21875	(97.30)	15192	(67.58)
90	(2286)	B22	2936	(13.06)	1867	(8.30)	3724	(16.56)	2270	(10.10)	1816	(8.08)
		B22A	13141	(58.45)	2667	(11.86)	16077	(71.51)	8778	(39.04)	6096	(27.11)
		B22X	28529	(126.90)	7227	(32.15)	34903	(155.25)	19057	(84.77)	13234	(58.87)
96	(2438)	B22	2728	(16.58)	1761	(7.83)	3456	(15.37)	2101	(9.34)	1671	(7.43)
		B22A	11951	(53.16)	2359	(10.49)	15291	(68.02)	7715	(34.32)	5357	(23.83)
		B22X	25945	(115.41)	6393	(28.44)	33197	(147.67)	16749	(74.50)	11630	(51.73)
102	(2591)	B22	2545	(11.32)	1664	(7.40)	3225	(14.34)	1951	(8.68)	1542**	(6.34)
		B22A	10678	(47.50)	2093	(9.31)	14455	(64.30)	6834	(30.40)	4746	(21.11)
		B22X	23182	(103.12)	5672	(25.23)	31382	(139.59)	14836	(65.99)	10303	(45.83)
108	(2743)	B22	2381	(10.59)	1575	(7.00)	3022	(13.44)	1816	(8.08)	1426**	(6.80)
		B22A	9524	(42.36)	1867	(8.30)	13568	(60.35)	6096	(27.11)	4233	(18.83)
		B22X	20676	(91.97)	5059	(22.50)	29456	(131.03)	13234	(58.87)	9190	(40.88)
114	(2895)	B22	2234	(9.94)	1494	(6.64)	2842	(12.64)	1694	(7.53)	1322**	(5.88)
		B22A	8548	(38.02)	1675	(7.45)	12630	(56.18)	5471	(24.33)	3799**	(16.90)
		B22X	18558	(82.55)	4539	(20.19)	27420	(121.97)	11877	(52.83)	8247	(36.68)
120	(3048)	B22	2101	(9.34)	1418	(6.31)	2680	(11.92)	1583**	(7.04)	1228**	(5.46)
		B22A	7715	(34.32)	1512	(6.72)	11642	(51.78)	4937	(21.96)	3429**	(15.25)
		B22X	16749	(74.50)	4097	(18.22)	25275	(112.43)	10718	(47.67)	7444	(33.11)

**Where the slenderness ratio $\frac{KL}{r}$ exceeds 200, and K = end fixity factor, L = actual length and r = radius of gyration.

Reference page 48 for general fitting and standard finish specifications.

Technical Data

Materials

Carbon Steel

Channels made from high-quality carbon steel are continuously roll formed to precise dimensions. By cold working the steel mechanical properties are increased, allowing lightweight structures to carry the required load. Corrosion resistance of carbon steel varies widely with coating and alloy. See "Finishes" for more detailed information.

Stainless Steel

Stainless steel channel is available in AISI Type 304 or 316 material. Both are non-magnetic and belong to the austenitic stainless steels group, based on alloy content and crystallographic structure. Like carbon steel, stainless steel exhibits increased strength when cold worked by roll-forming.

Several conditions make the use of stainless steel ideal. These include reducing long term maintenance costs, high ambient temperatures, appearance, and stable structural properties such as yield strength, and high creep strength.

Type 304 resists most organic chemicals, dyestuffs and a wide variety of inorganic chemicals at elevated or cryogenic temperatures. Type 316 contains slightly more nickel and adds molybdenum to give it better corrosion resistance in chloride and sulfuric acid environments. For more information concerning the differences between types 304 and 316, visit www.bline.com.

Aluminum

Standard aluminum channel is extruded from aluminum alloy 6063-T6. Strut fittings are made from aluminum alloy 5052-H32.

The high strength to weight ratio of channel made of aluminum helps greatly reduce the overall cost of installation through ease of handling and field cutting.

Aluminum owes its excellent corrosion resistance to its ability to form an aluminum oxide film that immediately reforms when scratched or cut. In most outdoor applications, aluminum has excellent resistance to "weathering". The resistance to chemicals, indoor or outdoor, can best be determined by tests conducted by the user with exposure to the specific conditions for which it is intended. The corrosion resistance of aluminum to some commonly known chemicals is shown in the Corrosion Chart on page 10. For further information, contact us or the Aluminum Association.

Fiberglass

We offer two fire retardant (FR) resins for strut systems, polyester and vinyl ester. Both resins are ideal for corrosive environments or nonconductive applications with moderate strength requirements. Some common types of environments where Vinyl Ester Resins are recommended, that Poly Esters are not, are paper mills, most any metal plating operation and any condition with

concentrated levels of Chlorine, [Cl⁻]. Please consult our fiberglass corrosion resistance charts on page 184 for specific chemical recommendation data.

Unlike other base materials depicted in this catalog, fiberglass exhibits unique physical property changes when operating in elevated temperature conditions that are a fraction of increase compared to steel or aluminum. Thus, it is advised against using fiberglass in temperatures greater than 200° F.

Please refer to the "Corrosion Resistance Guide" on page 184 for specific applications.

The fiberglass strut systems are manufactured from glass fiber-reinforced plastic shapes that meet ASTM E-84, Class 1 Flame Rating and self-extinguishing requirements of ASTM D-635. A surface veil is applied during pultrusion to insure a resin-rich surface and ultraviolet resistance.

While polyester is sufficient for most uses, vinyl ester is suitable for a broader range of environments.

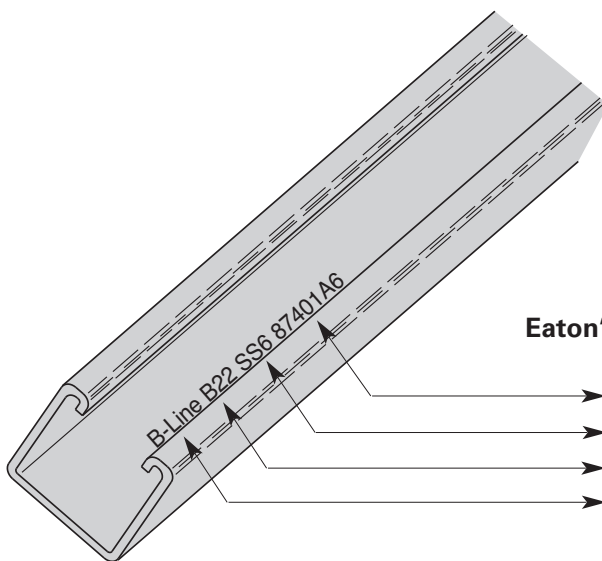

Eaton's B-Line Series Steel Strut is stamped with:

- Traceable to the steel's origin
- Material/Finish
- Part number designation
- Company Name

Finishes

Zinc Coatings

Zinc protects steel in two ways. First it protects the steel as a coating, and second acts as a sacrificial anode to repair bare areas such as cut edges, scratches, and gouges. The corrosion protection of zinc is directly related to its thickness and the environment. This means a .2 mil coating will last twice as long as a .1 mil coating in the same environment.

Galvanizing also protects cut and drilled edges.

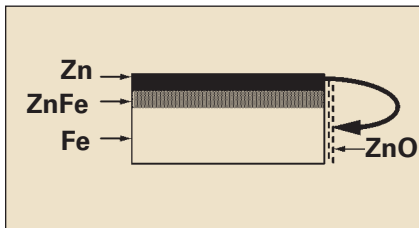

Electrogalvanized Zinc

Electrogalvanized Zinc (also known as zinc plated or electroplated) is the process by which a coating of zinc is deposited on the steel by electrolysis from a bath of zinc salts.

A rating of SC3, our standard, provides a minimum zinc coating thickness of .5 mils (excluding hardware, which is SC1 = .2 mils).

When exposed to air and moisture, zinc forms a tough, adherent, protective film consisting of a mixture of zinc oxides, hydroxides, and carbonates. This film is a barrier coating which helps slow subsequent corrosive attack on the zinc. This coating is usually recommended for indoor use in relatively dry areas, as it provides ninety-six hours protection in salt spray testing per ASTM B117.

Chromium / Zinc

Chromium / Zinc is a corrosion resistant composition, which was developed to protect fasteners and small bulk items for automotive use. The coating applications have since been extended to larger parts and other markets.

Chromium/Zinc composition is an aqueous coating dispersion containing chromium, proprietary organics, and zinc flake.

This finish provides 720 hours protection in salt spray testing per ASTM B117.

Pre-Galvanized Zinc

(Mill galvanized, hot dip mill galvanized or continuous hot dip galvanized) Pre-galvanized steel is produced by coating coils of sheet steel with zinc by continuously rolling the material through molten zinc at the mills. This is also known as mill galvanized or hot dip mill galvanized. These coils are then slit to size and fabricated by roll forming, shearing, punching, or forming to produce our pre-galvanized strut products.

The G90 specification calls for a coating of .90 ounces of zinc per square foot of steel. This results in a coating of .45 ounces per square foot on each side of the sheet. This is important when comparing this finish to hot dip galvanized after fabrication.

During fabrication, cut edges and welded areas are not normally zinc coated; however, the zinc near the uncoated metal becomes a sacrificial anode to protect the bare areas after a short period of time.

Hot Dip Galvanized After Fabrication (Hot dip galvanized or batch hot dip galvanized)

Hot dip galvanized strut products are fabricated from steel and then completely immersed in a bath of molten zinc. A metallic bond occurs resulting in a zinc coating that completely coats all surfaces, including edges and welds.

Another advantage of this method is coating thickness. Strut products that are hot dip galvanized after fabrication have a minimum thickness of 1.50 ounces per square foot on each side, or a total 3.0 ounces per square foot of steel, according to ASTM A123.

The zinc thickness is controlled by the amount of time each part is immersed in the molten zinc bath as well as the speed at which it is removed. The term "double dipping" refers to parts too large to fit into the galvanizing kettle and must be dipped one end at a time. It does not refer to extra coating thickness.

The layer of zinc which bonds to steel provides a dual protection against corrosion. It protects first as an overall barrier coating. If this coating happens to be scratched or gouged, zinc's secondary defense is called upon to protect the steel by galvanic action.

Hot-Dip Galvanized After Fabrication is recommended for prolonged outdoor exposure and will usually protect steel for 20 years or more in most atmospheric environments and in many industrial environments. For best results, a zinc rich paint (available from Eaton's B-Line Division) should be applied to field cuts. The zinc rich paint will provide immediate protection for these areas and eliminate the short time period for galvanic action to "heal" the damaged coating.

Anticipated Life of Zinc Coatings In Various Atmospheric Environments

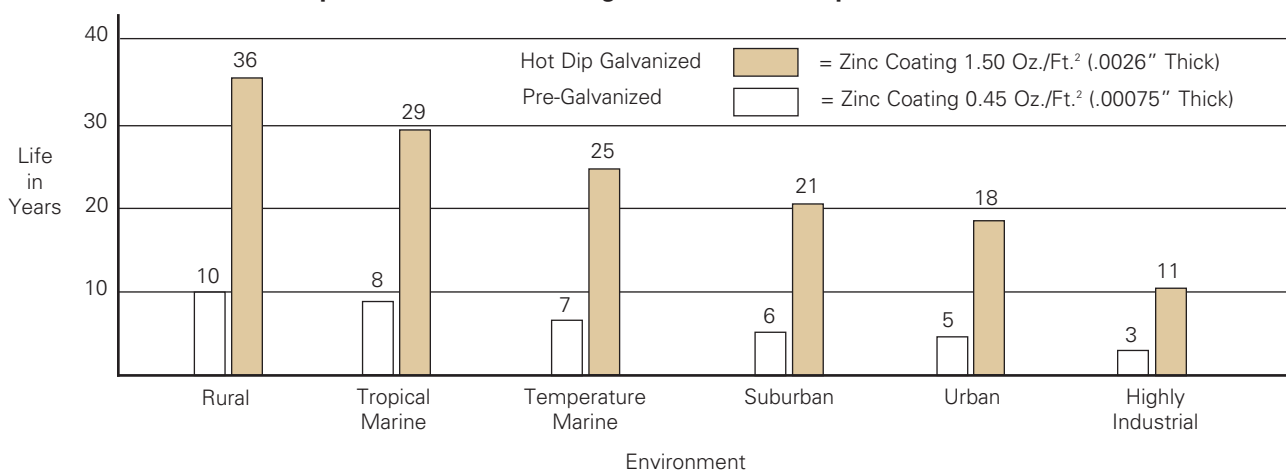

Technical Data

DURA GREEN™ and DURA-COPPER™ Epoxy Coatings

DURA GREEN and DURA-COPPER epoxy coatings are water borne epoxy coatings applied to B-Line series products by a precisely controlled cathodic electro-deposition process. This process is accomplished using a conveyor to transport channel and fittings through several cleaning, phosphatizing and application stages prior to being baked (See diagram below).

This custom-designed paint system is used for painting all channels, channel combinations, slotted angle, and fittings.

Samples are selected on a routine basis for salt spray (fog) testing to verify the quality of the finish. These tests are performed in accordance with ASTM B117 and evaluated and related according to ASTM D1654 (Tables 1 & 2).

The DURA GREEN and DURA-COPPER epoxy coatings have been tested and listed by Underwriters Laboratories in

accordance with "Standard for Surface Metal Raceway and Fittings, UL5" and "Standard for Pipe Hanger Equipment for Fire Protection Service, UL203".

Due to DURA GREEN's organically based composition, it seats itself into porous surfaces more completely and efficiently than zinc coatings. As these porous caverns are filled along the material profile, the outer finished surface demonstrates an increased smooth uniform plane which produces considerably less off-gasing when tested.

DURA GREEN channel meets or exceeds 100 level clean room standards. This was confirmed by testing the channel in accordance with Boeing (PCL) Standards, which are more stringent and complete than ASTM E595-93. DURA GREEN was found to be a superior finish, due in part to its proven application process.

Technical Data

Salt Spray Test Results

Type of Finish	Unscribed 5% Failure (1)	Scribed 1/8" (3.2) Creepage from Scribe (1)
DURA GREEN Epoxy	1000 Hours	312 Hours
Mill Galv. (Pre-Galv.) G90	192 Hours	288 Hours
Perma-Green	438 Hours	231 Hours
Zinc Chromate	36 Hours	96 Hours
Industry Green (Range)	10 to 36 Hours	4 to 30 Hours

(1) All salt spray (fog) tests conducted in accordance with ASTM B117 and evaluated and rated according to ASTM D1654 Tables 1 & 2. Tests are performed and certified by an independent testing laboratory.

DURA GREEN / DURA-COPPER Epoxy Coating Process

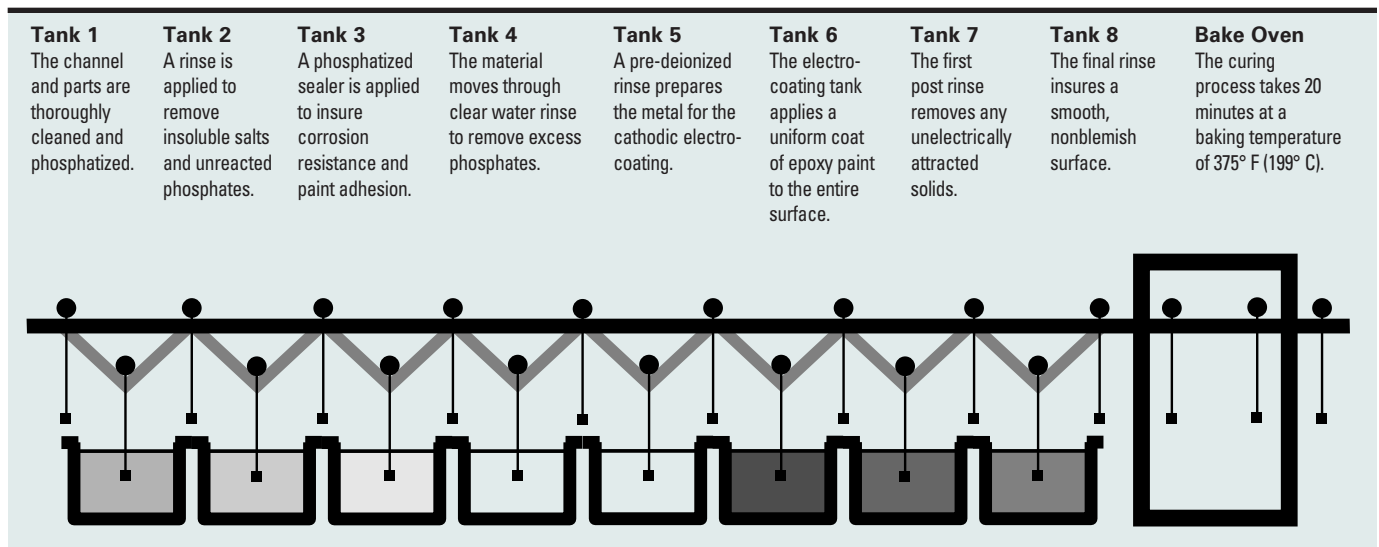

Metal Framing Channels

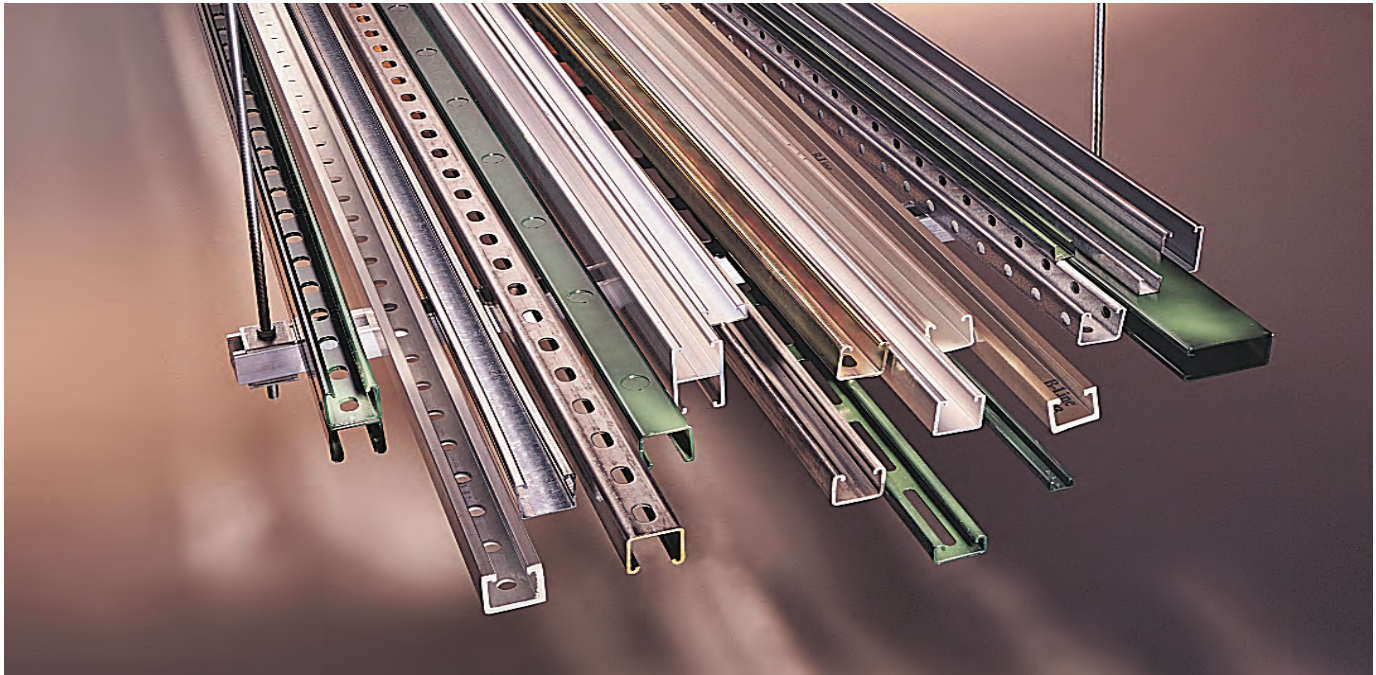

Channel

Metal framing channel is cold formed on our modern rolling mills from 12 Ga. (2.6mm), 14 Ga. (1.9mm), and 16 Ga. (1.5mm) low carbon steel strips. A continuous slot with inturned lips provides the ability to make attachments at any point.

Lengths & Tolerances

All channels excluding 'SH' style $\pm 1/8"$ (3.2mm) on 10' (3.05m) and $\pm 3/16"$ (4.76mm) on 20' (6.09m)

All 'SH' channels only $\pm 1/4"$ (6.35mm) on 10' (3.05m) and $\pm 1/2"$ (12.70mm) on 20' (6.09m)

Custom lengths are available upon request.

Slots

Slotted series of channels offer full flexibility. A variety of pre-punched slot patterns eliminate the need for precise field measuring for hole locations. Slots offer wide adjustments in the alignment and bolt sizing.

Holes

A variety of pre-punched $9/16"$ (14.3 mm) diameter hole patterns are available in our channels. These hole patterns provide an economical alternative to costly field drilling required for many applications.

Knockouts

When used with series B217-20 Closure Strips, knockout channels can be used to provide an economical U.L. listed surface raceway. Channels are furnished with $7/8"$ (22.2 mm) knockouts on 6" (152 mm) centers, allowing for perfect fixture alignment on spans up to 20' (6.09 m).

Materials & Finishes (Unless otherwise noted)

Steel: Plain & Pre-galvanized

12 Ga. (2.6), 14 Ga. (1.9) and 16 Ga. (1.5)

Note: A minimum order may apply on special material and finishes.

Design Load (Steel & Stainless Steel)

The design loads given for strut beam loads are based on a simple beam condition using an allowable stress of 25,000 psi. This allowable stress results in a safety factor of 1.68. This is based upon virgin steel minimum yield strength of 33,000 psi cold worked during rolling to an average yield stress of 42,000 psi. For aluminum channel loading multiply steel loading by a factor of 0.38.

Welding







Weld spacing is maintained between 2 $1/2$ inches (63.5 mm) and 4 inches (101.6 mm) on center. Through high quality control testing of welded channels and continuous monitoring of welding equipment, we provide the most consistent combination channels available today.

Metric

Metric dimensions are shown in parentheses. Unless noted, all metric dimensions are in millimeters.

Finish Code	Finish	Specification
PLN	Plain	ASTM A1011, 33,000 PSI min. yield
GRN	DURA GREEN™	
GLV	Pre-Galvanized	ASTM A653 33,000 PSI min. yield
HDG	Hot-Dipped Galvanized	ASTM A123
YZN	Yellow Zinc Chromate	ASTM B633 SC3 Type II
SS4	Stainless Steel Type 304	ASTM A240
SS6	Stainless Steel Type 316	ASTM A240
AL	Aluminum	Aluminum 6063-T6

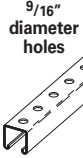
Selection Chart for Channels, Materials and Hole Patterns

Channel Type	Channel Dimensions		Material & Thickness * Stainless Steel				Channel Hole Pattern **				
	Height	Width	Steel	Alum.	Type 304	Type 316	SH	S	H17/8	TH	KO6
			<u>1</u>	<u>2</u>	<u>3</u>	<u>4</u>					
B11	3 1/4" (82.5)	1 5/8" (41.3)	12 Ga.	.105	–	–	<u>1</u>	<u>1</u>	<u>1</u>	–	<u>1</u>
B12	2 7/16" (61.9)	1 5/8" (41.3)	12 Ga.	.105	–	–	<u>1 2</u>	<u>1</u>	<u>1 2</u>	–	<u>1 2</u>
B22	1 5/8" (41.3)	1 5/8" (41.3)	12 Ga.	.105	12 Ga.	12 Ga.	<u>1 2 3 4</u>	<u>1 3</u>	<u>1 2 3 4</u>	<u>1</u>	<u>1 2</u>
B24	1 5/8" (41.3)	1 5/8" (41.3)	14 Ga.	.080	14 Ga.	14 Ga.	<u>1 2 3 4</u>	<u>1</u>	<u>1 2 3 4</u>	–	<u>1 2</u>
B26	1 5/8" (41.3)	1 5/8" (41.3)	16 Ga.	–	–	–	<u>1</u>	<u>1</u>	<u>1</u>	–	<u>1</u>
B32	1 3/8" (34.9)	1 5/8" (41.3)	12 Ga.	–	12 Ga.	–	<u>1 3</u>	<u>1</u>	<u>1 3</u>	–	<u>1</u>
B42	1" (25.4)	1 5/8" (41.3)	12 Ga.	–	12 Ga.	–	<u>1 3</u>	<u>1</u>	<u>1 3</u>	–	<u>1</u>
B52	1 3/16" (20.6)	1 5/8" (41.3)	12 Ga.	–	12 Ga.	12 Ga.	<u>1 3 4</u>	<u>1</u>	<u>1</u>	–	<u>1</u>
B54	1 3/16" (20.6)	1 5/8" (41.3)	14 Ga.	.080	14 Ga.	14 Ga.	<u>1 2 3 4</u>	<u>1</u>	<u>1 2 3 4</u>	–	<u>1 2</u>
B56	1 3/16" (20.6)	1 5/8" (41.3)	16 Ga.	–	–	–	<u>1</u>	<u>1</u>	<u>1</u>	–	<u>1</u>
B62	1 3/16" (20.6)	1 3/16" (20.6)	18 Ga.	–	–	–	–	–	–	–	–
B72	1 3/32" (10.3)	1 3/16" (20.6)	18 Ga.	–	–	–	–	–	–	–	–

The selection has been prepared to provide a reference for available channel, materials and hole patterns. Material types available for various hole patterns are defined by numbers 1 thru 4. Some stainless steel channels with hole patterns are available on special order only.

*Metric equivalent for thicknesses shown in chart. ** 1 - Steel
 12 Ga. = 2.6 mm 18 Ga. = 1.2 mm 2 - Aluminum
 14 Ga. = 1.9 mm .105 = 2.6 mm 3 - Type 304 Stainless Steel
 16 Ga. = 1.5 mm .080 = 2.0 mm 4 - Type 316 Stainless Steel

Properties may vary due to commercial tolerances of the material.

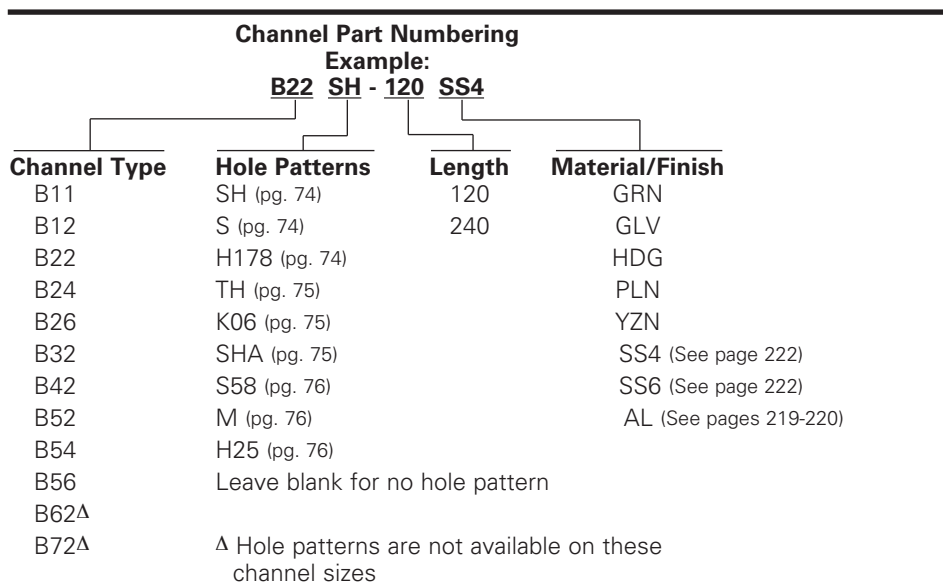

Reference page 48 for general fitting and standard finish specifications.

B22 Channel

B22

- Thickness: 12 Gauge (2.6 mm)
- Standard lengths: 10' (3.05 m) & 20' (6.09 m)
- Standard finishes: Plain, DURA GREEN™, Pre-Galvanized, Hot-Dipped Galvanized, Stainless Steel Type 304 or 316, Aluminum
- Weight: 1.90 Lbs./Ft. (2.83 kg/m)

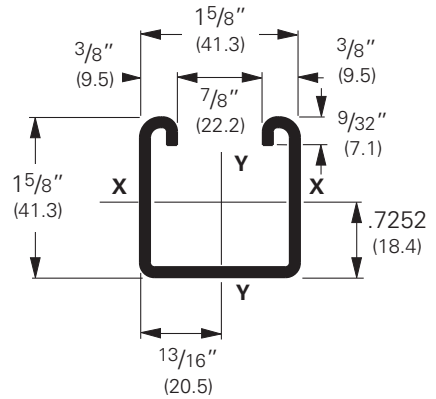
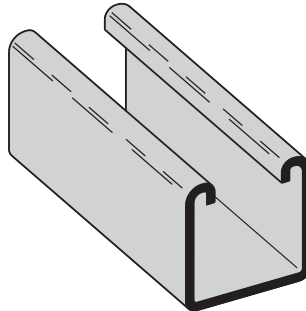

Note:

Aluminum loading, for B22 & B22A, can be determined by multiplying load data times a factor of 0.38

Section Properties			X - X Axis				Y - Y Axis									
Channel	Weight		Areas of Section	Moment of Inertia (I)		Section Modulus (S)	Radius of Gyration (r)	Moment of Inertia (I)		Section Modulus (S)	Radius of Gyration (r)					
	lbs./ft.	kg/m		sq. in.	cm ²			in. ⁴	cm ⁴			in. ⁴	cm ⁴	in. ³	cm ³	in.
B22	1.910	(2.84)	.562	(3.62)	.1912	(7.96)	.2125	(3.48)	.583	(1.48)	.2399	(9.99)	.2953	(4.84)	.653	(1.66)
B22A	3.820	(5.69)	1.124	(7.25)	.9732	(40.51)	.5989	(9.81)	.931	(2.36)	.4798	(19.97)	.5905	(9.68)	.653	(1.66)
B22X	6.649	(9.89)	1.956	(12.62)	4.1484	(172.67)	1.7019	(27.89)	1.456	(3.70)	1.1023	(45.88)	1.2027	(19.71)	.751	(1.91)

Calculations of section properties are based on metal thicknesses as determined by the AISI Cold-Formed Steel Design Manual.

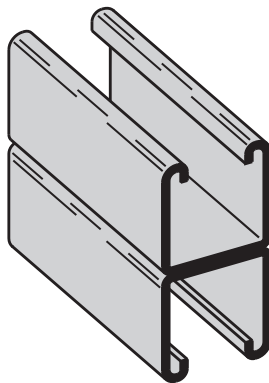

B22A

Wt. 3.80 Lbs./Ft. (5.65 kg/m)

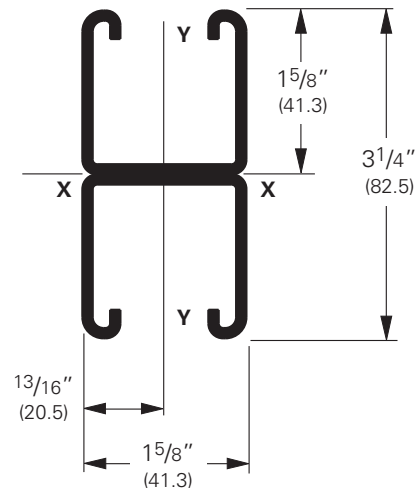

B22 Beam Loading Data

Beam Loading

Beam Span In. mm		Channel Style	Uniform Load and Deflection				Uniform Load @ Deflection =			
			Lbs.		kN		1/240 Span		1/360 Span	
			Lbs.	kN	In.	mm	Lbs.	kN	Lbs.	kN
12	(305)	B22	2610	(11.61)	.014	(.35)	2610	(11.61)	2610	(11.61)
		B22A	2610*	(11.61)	.002	(.05)	2610*	(11.61)	2610*	(11.61)
		B22X	5790*	(25.75)	.001	(.02)	5790*	(25.75)	5790*	(25.75)
18	(457)	B22	2269	(10.09)	.031	(.79)	2269	(10.09)	2269	(10.09)
		B22A	2610*	(11.61)	.007	(.18)	2610*	(11.61)	2610*	(11.61)
		B22X	5790*	(25.75)	.003	(.07)	5790*	(25.75)	5790*	(25.75)
24	(609)	B22	1702	(7.57)	.056	(1.42)	1702	(7.57)	1702	(7.57)
		B22A	2610*	(11.61)	.017	(.43)	2610*	(11.61)	2610*	(11.61)
		B22X	5790*	(25.75)	.008	(.20)	5790*	(25.75)	5790*	(25.75)
30	(762)	B22	1361	(6.05)	.087	(2.21)	1361	(6.05)	1294	(5.75)
		B22A	2610*	(11.61)	.033	(.84)	2610*	(11.61)	2610*	(11.61)
		B22X	5790*	(25.75)	.017	(.73)	5790*	(25.75)	5790*	(25.75)
36	(914)	B22	1135	(5.05)	.126	(3.20)	1135	(5.05)	899	(4.00)
		B22A	2610*	(11.61)	.057	(1.45)	2610*	(11.61)	2610*	(11.61)
		B22X	5790*	(25.75)	.029	(.73)	5790*	(25.75)	5790*	(25.75)
42	(1067)	B22	972	(4.32)	.172	(4.37)	972	(4.32)	660	(2.93)
		B22A	2610*	(11.61)	.091	(2.31)	2610*	(11.61)	2610*	(11.61)
		B22X	5790*	(25.75)	.046	(1.17)	5790*	(25.75)	5790*	(25.75)
48	(1219)	B22	851	(3.78)	.224	(5.69)	758	(3.37)	505	(2.24)
		B22A	2405	(10.70)	.125	(3.17)	2405	(10.70)	2405	(10.70)
		B22X	5790*	(25.75)	.068	(1.73)	5790*	(25.75)	5790*	(25.75)
54	(1371)	B22	756	(3.36)	.284	(7.21)	599	(2.66)	399	(1.77)
		B22A	2138	(9.51)	.158	(4.01)	2138	(9.51)	2024	(9.00)
		B22X	5790*	(25.75)	.097	(2.46)	5790*	(25.75)	5790*	(25.75)
60	(1524)	B22	681	(3.03)	.351	(8.91)	485	(2.16)	323	(1.44)
		B22A	1924	(8.56)	.195	(4.95)	1924	(8.56)	1640	(7.29)
		B22X	5645	(25.11)	.130	(3.30)	5645	(25.11)	5645	(25.11)
66	(1676)	B22	619	(2.75)	.424	(10.77)	401	(1.78)	267	(1.19)
		B22A	1749	(7.78)	.236	(5.99)	1749	(7.78)	1355	(6.03)
		B22X	5132	(22.83)	.158	(4.01)	5132	(22.83)	5132	(22.83)
72	(1829)	B22	567	(2.52)	.505	(12.83)	337	(1.50)	225	(1.00)
		B22A	1603	(7.13)	.281	(7.14)	1603	(7.13)	1139	(5.06)
		B22X	4704	(20.92)	.188	(4.77)	4704	(20.92)	4704	(20.92)
78	(1981)	B22	524	(2.33)	.593	(15.06)	287	(1.27)	191	(0.85)
		B22A	1480	(6.58)	.330	(8.38)	1455	(6.47)	970	(4.31)
		B22X	4342	(19.31)	.220	(5.59)	4342	(19.31)	4270	(18.99)
84	(2133)	B22	486	(2.16)	.687	(17.45)	248	(1.10)	165	(0.73)
		B22A	1374	(6.11)	.383	(9.73)	1255	(5.58)	837	(3.72)
		B22X	4032	(17.93)	.255	(6.48)	4032	(17.93)	3682	(16.38)
90	(2286)	B22	454	(2.02)	.789	(20.04)	216	(0.96)	144	(0.64)
		B22A	1283	(5.71)	.440	(11.17)	1093	(4.86)	729	(3.24)
		B22X	3763	(16.74)	.293	(7.44)	3763	(16.74)	3207	(14.26)
96	(2438)	B22	425	(1.89)	.898	(22.81)	190	(0.84)	126	(0.56)
		B22A	1202	(5.35)	.500	(12.70)	961	(4.27)	640	(2.85)
		B22X	3528	(15.69)	.334	(8.48)	3528	(15.69)	2819	(12.54)
102	(2591)	B22	400	(1.78)	1.013	(25.73)	168	(0.75)	112	(0.50)
		B22A	1132	(5.03)	.565	(14.35)	851	(3.78)	567	(2.52)
		B22X	3320	(14.77)	.377	(9.57)	3320	(14.77)	2497	(11.11)
108	(2743)	B22	378	(1.68)	1.136	(28.85)	150	(0.67)	100	(0.44)
		B22A	1069	(4.75)	.633	(16.08)	759	(3.37)	506	(2.25)
		B22X	3136	(13.95)	.422	(10.72)	3136	(13.95)	2227	(9.90)
114	(2895)	B22	358	(1.59)	1.266	(32.15)	134	(0.59)	90	(0.40)
		B22A	1013	(4.50)	.706	(17.93)	681	(3.03)	454	(2.02)
		B22X	2971	(13.21)	.471	(11.96)	2971	(13.21)	1999	(8.89)
120	(3048)	B22	340	(1.51)	1.403	(35.63)	121	(0.54)	81	(0.36)
		B22A	962	(4.28)	.782	(19.86)	615	(2.73)	410	(1.82)
		B22X	2822	(12.55)	.521	(13.23)	2706	(12.04)	1804	(8.02)

Based on simple beam condition using an allowable design stress of 25,000 psi (172 MPa) in accordance with MFMA, with adequate lateral bracing (see page 12 for further explanation). Actual yield point of cold rolled steel is 42,000 psi. To determine concentrated load capacity at mid span, multiply uniform load by 0.5 and corresponding deflection by 0.8. *Failure determined by weld shear.

Reference page 48 for general fitting and standard finish specifications.

B22 Column Loading Data

Column Loading

Unbraced Height		Channel Style	Max. Column Loading K = .80				Max. Column Loading (Loaded @ C.G.)					
			Loaded@ C.G.		Loaded@ Slot Face		K = .65		K = 1.0		K = 1.2	
In.	mm		Lbs.	kN	Lbs.	kN	Lbs.	kN	Lbs.	kN	Lbs.	kN
12	(305)	B22	10454	(46.50)	4276	(19.12)	10598	(47.14)	10222	(45.47)	9950	(44.26)
		B22A	21625	(96.19)	7002	(31.14)	21677	(96.42)	21539	(95.81)	21433	(95.34)
		B22X	46948	(208.83)	18975	(84.40)	47061	(209.34)	46761	(208.00)	46531	(206.98)
18	(457)	B22	9950	(44.26)	4153	(18.47)	10253	(45.62)	9481	(42.17)	8955	(39.83)
		B22A	21433	(95.34)	6959	(30.95)	21551	(95.86)	21239	(94.47)	21001	(93.42)
		B22X	46531	(206.98)	18859	(83.90)	46787	(208.12)	46110	(205.11)	45593	(202.81)
24	(609)	B22	9311	(41.42)	3993	(17.76)	9801	(43.60)	8582	(38.17)	7801	(34.70)
		B22A	21164	(94.14)	6898	(30.68)	21373	(95.07)	20819	(92.61)	20397	(90.73)
		B22X	45947	(204.38)	18693	(84.44)	46401	(206.40)	45198	(201.05)	44282	(196.97)
30	(762)	B22	8582	(38.17)	3802	(16.91)	9268	(41.22)	7601	(33.81)	6595	(29.33)
		B22A	20819	(92.61)	6821	(30.34)	21145	(94.06)	20279	(90.20)	19619	(87.27)
		B22X	45198	(201.05)	18485	(82.22)	45906	(204.20)	44026	(195.84)	42593	(189.46)
36	(914)	B22	7801	(34.70)	3589	(15.96)	8676	(38.59)	6595	(28.33)	5392	(23.98)
		B22A	20397	(90.73)	6728	(29.93)	20866	(92.81)	19619	(87.27)	18669	(83.04)
		B22X	44282	(196.97)	18233	(81.10)	45300	(201.50)	42593	(189.46)	40530	(180.28)
42	(1067)	B22	6998	(31.13)	3360	(14.94)	8048	(35.80)	5595	(24.89)	4444	(19.77)
		B22A	19898	(88.51)	6620	(29.45)	20537	(91.33)	18840	(83.80)	17546	(78.05)
		B22X	43198	(192.15)	17940	(79.80)	44586	(198.33)	40901	(181.94)	38092	(169.44)
48	(1219)	B22	6193	(27.55)	3118	(13.87)	7401	(32.92)	4718	(20.99)	3791	(16.86)
		B22A	19322	(85.95)	6496	(28.89)	20157	(89.66)	17940	(79.80)	16251	(72.29)
		B22X	41948	(186.59)	17604	(78.30)	43761	(194.57)	38948	(173.25)	35281	(156.94)
54	(1371)	B22	5392	(23.98)	2864	(12.74)	6746	(30.01)	4090	(18.19)	3310	(14.72)
		B22A	18669	(83.04)	6263	(27.86)	19276	(87.74)	16920	(75.26)	14782	(65.75)
		B22X	40530	(180.28)	16973	(75.50)	42825	(190.49)	36733	(163.39)	32092	(142.75)
60	(1524)	B22	4718	(20.99)	2631	(11.70)	6093	(27.10)	3616	(16.08)	2936	(13.06)
		B22A	17940	(79.80)	5340	(23.75)	19244	(85.60)	15781	(70.20)	13141	(58.45)
		B22X	38948	(173.25)	14471	(64.37)	41779	(185.84)	34260	(152.39)	28529	(126.90)
66	(1676)	B22	4202	(18.69)	2434	(10.83)	5441	(24.20)	3242	(14.42)	2634	(11.71)
		B22A	17134	(76.21)	4587	(20.40)	18712	(83.23)	14521	(64.59)	11328	(50.39)
		B22X	37198	(165.46)	12431	(55.29)	40624	(180.70)	31525	(140.23)	24593	(109.39)
72	(1829)	B22	3791	(16.86)	2264	(10.07)	4869	(21.66)	2936	(13.06)	2381	(10.59)
		B22A	16251	(72.29)	3968	(17.65)	18129	(80.64)	13141	(58.45)	9524	(42.36)
		B22X	35281	(156.94)	10753	(47.83)	39358	(175.07)	28529	(126.90)	20676	(91.97)
78	(1981)	B22	3456	(15.37)	2116	(9.41)	4412	(19.62)	2680	(11.92)	2166	(9.63)
		B22A	15291	(68.02)	3456	(15.37)	17496	(77.82)	11642	(51.78)	8115	(36.10)
		B22X	33197	(147.67)	9366	(41.66)	37984	(168.96)	25275	(112.43)	17617	(78.36)
84	(2133)	B22	3176	(14.13)	1984	(8.82)	4037	(17.96)	2461	(10.95)	1980	(8.81)
		B22A	14255	(63.41)	3028	(13.47)	16812	(74.78)	10076	(44.82)	6998	(31.13)
		B22X	30947	(137.66)	8206	(36.50)	36499	(162.35)	21875	(97.30)	15192	(67.58)
90	(2286)	B22	2936	(13.06)	1867	(8.30)	3724	(16.56)	2270	(10.10)	1816	(8.08)
		B22A	13141	(58.45)	2667	(11.86)	16077	(71.51)	8778	(39.04)	6096	(27.11)
		B22X	28529	(126.90)	7227	(32.15)	34903	(155.25)	19057	(84.77)	13234	(58.87)
96	(2438)	B22	2728	(16.58)	1761	(7.83)	3456	(15.37)	2101	(9.34)	1671	(7.43)
		B22A	11951	(53.16)	2359	(10.49)	15291	(68.02)	7715	(34.32)	5357	(23.83)
		B22X	25945	(115.41)	6393	(28.44)	33197	(147.67)	16749	(74.50)	11630	(51.73)
102	(2591)	B22	2545	(11.32)	1664	(7.40)	3225	(14.34)	1951	(8.68)	1542**	(6.34)
		B22A	10678	(47.50)	2093	(9.31)	14455	(64.30)	6834	(30.40)	4746	(21.11)
		B22X	23182	(103.12)	5672	(25.23)	31382	(139.59)	14836	(65.99)	10303	(45.83)
108	(2743)	B22	2381	(10.59)	1575	(7.00)	3022	(13.44)	1816	(8.08)	1426**	(68.60)
		B22A	9524	(42.36)	1867	(8.30)	13568	(60.35)	6096	(27.11)	4233	(18.83)
		B22X	20676	(91.97)	5059	(22.50)	29456	(131.03)	13234	(58.87)	9190	(40.88)
114	(2895)	B22	2234	(9.94)	1494	(6.64)	2842	(12.64)	1694	(7.53)	1322**	(5.88)
		B22A	8548	(38.02)	1675	(7.45)	12630	(56.18)	5471	(24.33)	3799**	(16.90)
		B22X	18558	(82.55)	4539	(20.19)	27420	(121.97)	11877	(52.83)	8247	(36.68)
120	(3048)	B22	2101	(9.34)	1418	(6.31)	2680	(11.92)	1583**	(7.04)	1228**	(5.46)
		B22A	7715	(34.32)	1512	(6.72)	11642	(51.78)	4937	(21.96)	3429**	(15.25)
		B22X	16749	(74.50)	4097	(18.22)	25275	(112.43)	10718	(47.67)	7444	(33.11)

**Where the slenderness ratio $\frac{KL}{r}$ exceeds 200, and K = end fixity factor, L = actual length and r = radius of gyration.

Reference page 48 for general fitting and standard finish specifications.