



# KT-ALED290PS-L2-OSB-PMA-8CSB-VDIM-P

## POLE-MOUNT LED AREA LIGHT PREMIUM PACKAGE

### DESCRIPTION

290W Power and Color Select Optic Swap LED Area Light | 120-277V Input | Bronze Housing | Adjustable Pole Mount Kit Included

### APPLICATION

Pole-mount or structure-mount outdoor illumination needs (including parking lots, auto dealerships, pathways, roadways, recreational venues, and other general area lighting requirements)

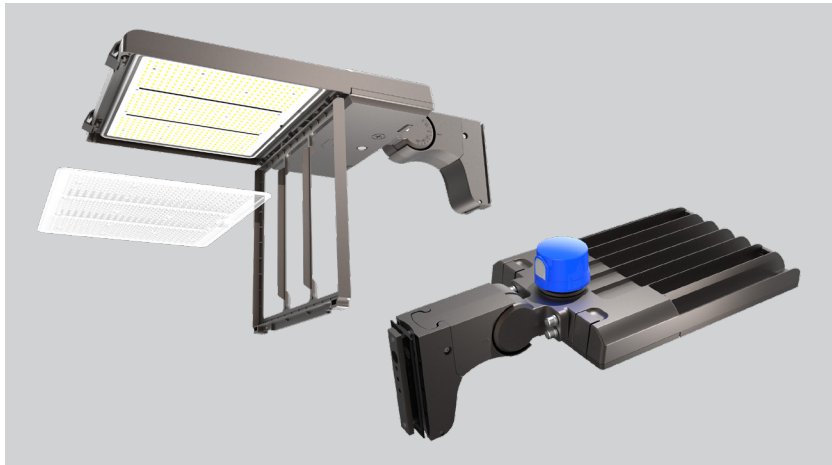

### PRODUCT FEATURES

- Keystone Power Select technology (290/210/185W)
- Keystone Color Select technology (3000/4000/5000K)
- Innovative optic swap capability under door frame and latch design for quick lens change
- Three lenses in the box: Type III installed, Types IV and V included
- Type II lens sold separately. See below for details
- Heavy duty die cast aluminum housing with ample heat sinking
- Low-profile design delivers high-performance illumination and improves application site aesthetics
- True U0 design for Dark Sky friendly performance that eliminates undesirable sky glow
- Integrated NEMA/ANSI C136.10 7-pin twist-lock receptacle with 3-pin photocell and shorting cap. Standard on all fixtures, simplifies ordering requirements for photo control needs
- Comes with a pre-installed adjustable pole mount kit for easy and quick mounting to square or round poles
- Keystone 0-10V dimming driver
- Ambient operating temperature: -40°C/-40°F to 50°C/122°F
- UL Certified, IP65 rated
- Power factor: > 0.95
- THD: < 20%
- LED chip lifetime: L70 > 100,000 hrs @ 25°C/77°F ambient fixture temperature
- Meets FCC Part 15, Part B, Class A standards for conducted and radiated emissions

### PRODUCT SPECIFICATIONS

Catalog No.	Wattage	CCT	Lumens	Efficacy	Input Voltage	Dimming	CRI	Distribution Pattern	Photocell Included	Housing Color	Legacy Equivalent
KT-ALED290PS-L2-OSB-PMA-8CSB-VDIM-P	290W	3000K	36320	125 lm/W	120-277V	0-10V	>80	Type III Installed, Types IV and V Included	Yes	Bronze	1000W MH
		4000K	42770	147 lm/W							
		5000K	38700	133 lm/W							
	210W	3000K	27300	130 lm/W							
		4000K	31710	151 lm/W							
		5000K	28980	138 lm/W							
	185W	3000K	22970	124 lm/W							
		4000K	27060	146 lm/W							
		5000K	24440	132 lm/W							

\* Fixtures with Type 2 (II) and Type 4 (IV) optics are available and assembled to order. Lead times may apply. Type II (2) lenses are sold separately. For more information, see accessories page below or contact Keystone with questions.  
 \*\*Fixtures (and mounts) with alternate housing colors are available and made to order. Extended lead times apply. Please see catalog number breakdown for full ordering code details.

# KT-ALED290PS-L2-OSB-PMA-8CSB-VDIM-P

## POLE-MOUNT LED AREA LIGHT PREMIUM PACKAGE

### PHYSICAL SPECIFICATIONS

#### POLE-MOUNT LED AREA LIGHT FIXTURE

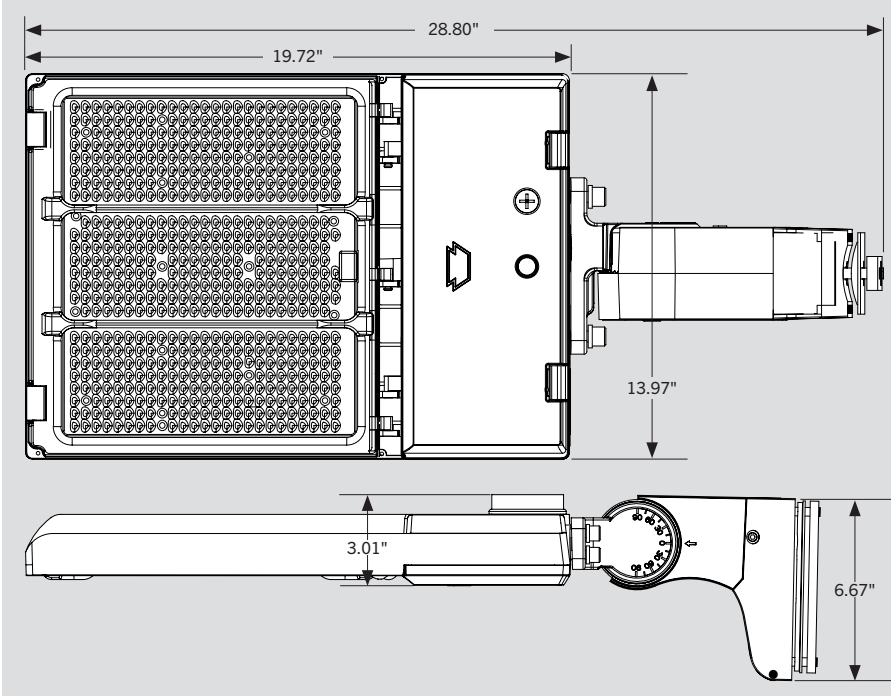

#### PACKAGING

Carton Quantity	1 piece
Carton Dimensions	5.63"H x 15.95"W x 26.18"L
Carton Weight	17.53 lbs

#### ADJUSTABLE POLE MOUNT KIT DRILLING HOLES

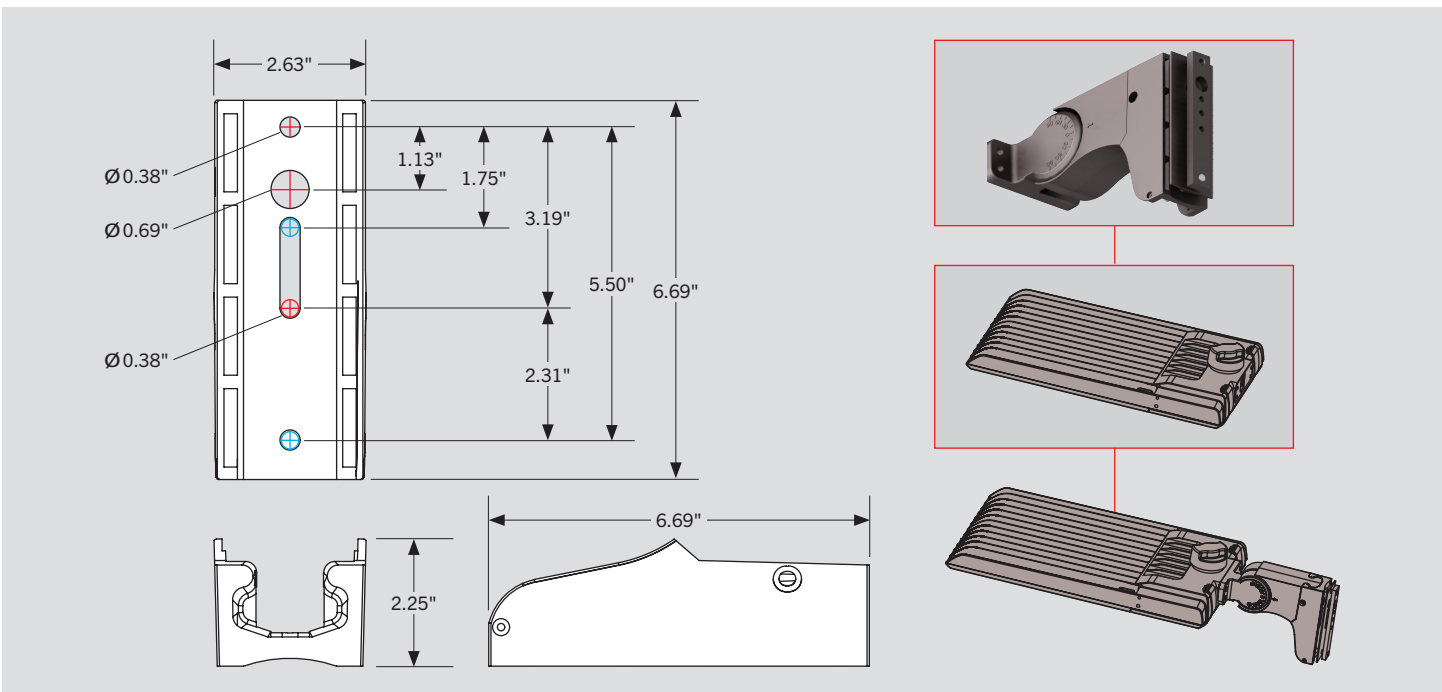

# KT-ALED290PS-L2-OSB-PMA-8CSB-VDIM-P

## POLE-MOUNT LED AREA LIGHT PREMIUM PACKAGE

### WIRING DIAGRAM

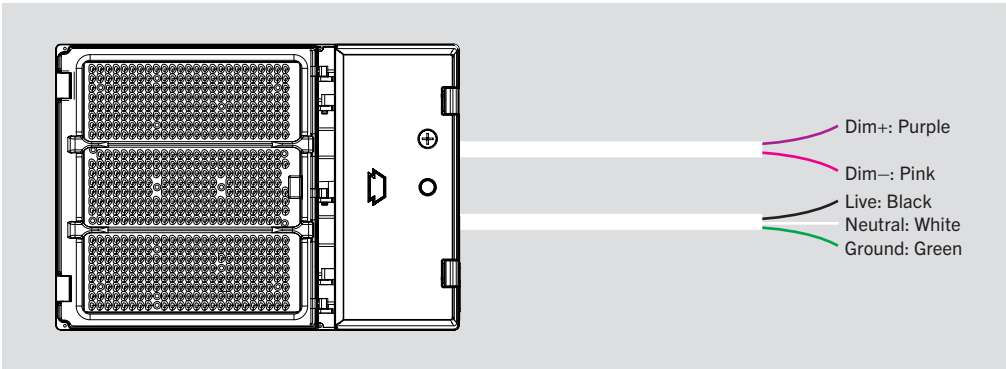

- This fixture comes pre-wired with a 7-pin twist-lock receptacle with shorting cap. Make input connections as needed and ensure connections are protected from exposure to the elements.
- **Input voltage rating: 120–277V**
- Ensure that input voltage on site matches the fixture you intend to install.

### POWER SELECT (WATTAGE) AND COLOR SELECT (CCT) ADJUSTMENT

This fixture is equipped with field-adjustable Keystone Power Select and Color Select technology.

1. Ensure power is off to the fixture.
2. Open the driver compartment located on the underside of the fixture.
3. Adjust switches to desired settings.

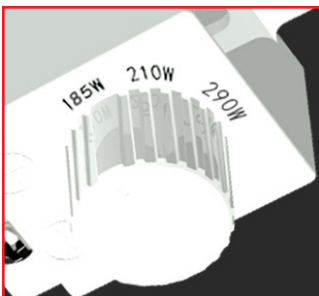

#### POWER SELECT ADJUSTMENT DIAL

Set switch to adjust wattage between 290W, 210W, and 185W. Fixture comes preset at 290W.

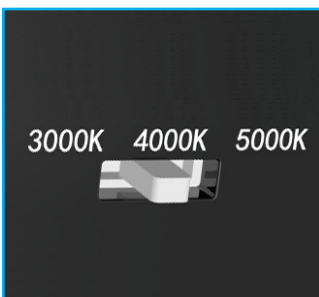

#### COLOR SELECT ADJUSTMENT SWITCH

Set switch to adjust CCT between 3000K, 4000K, and 5000K. Fixture comes preset at 5000K.

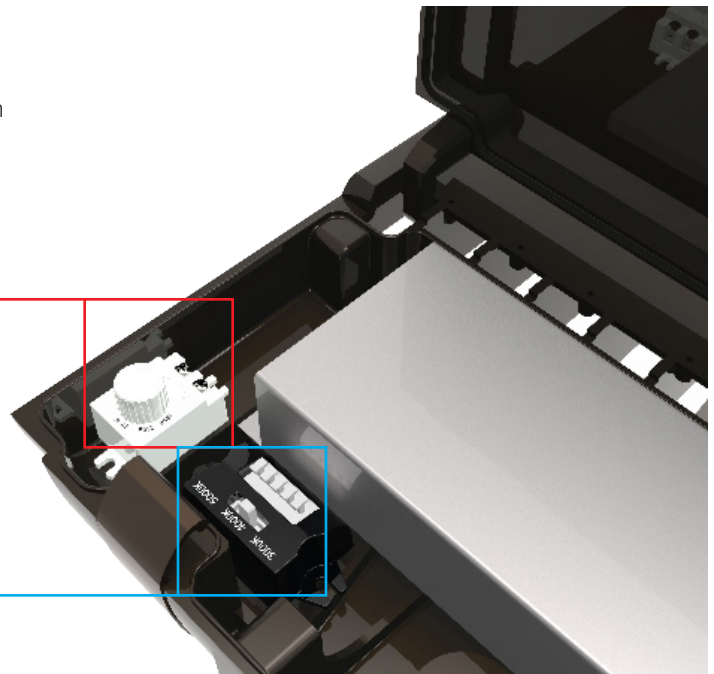

# KT-ALED290PS-L2-OSB-PMA-8CSB-VDIM-P

## POLE-MOUNT LED AREA LIGHT PREMIUM PACKAGE

### LIGHT DISTRIBUTION PATTERN

#### TYPE III (3)

Pole mount view from above. Area light mounted at 30 ft.  
Each square is 10 ft x 10 ft

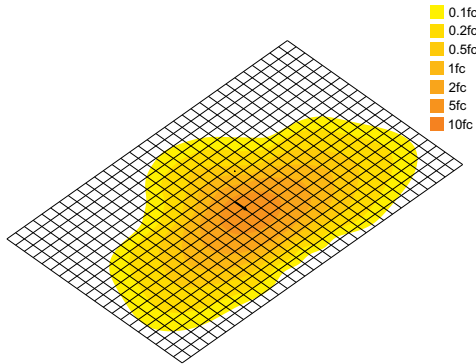

#### TYPE V (5)

Pole mount view from above. Area light mounted at 30 ft.  
Each square is 10 ft x 10 ft

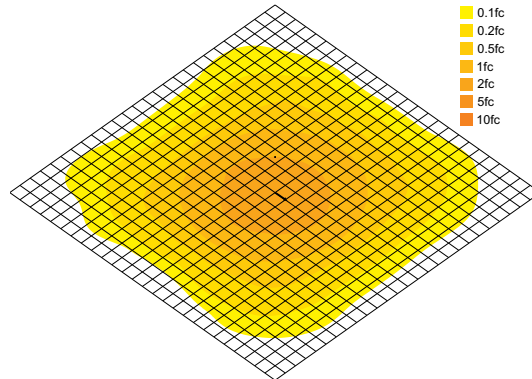

### PHOTOMETRIC SPECIFICATIONS (TYPE III [3])

#### ISOCANDELA PLOT

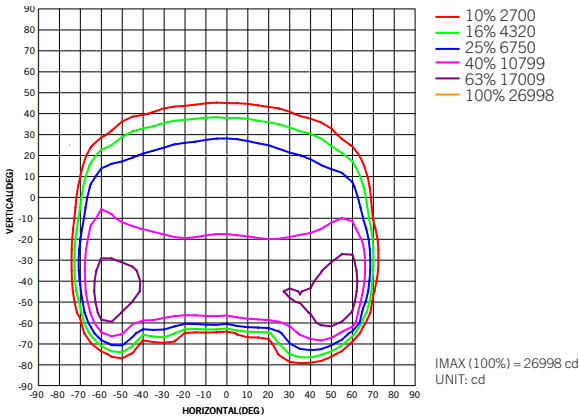

#### LUMINOUS INTENSITY DISTRIBUTION

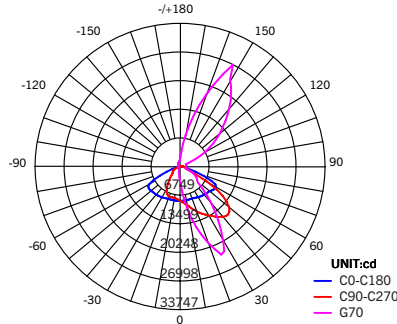

### PHOTOMETRIC SPECIFICATIONS (TYPE V [5])

#### ISOCANDELA PLOT

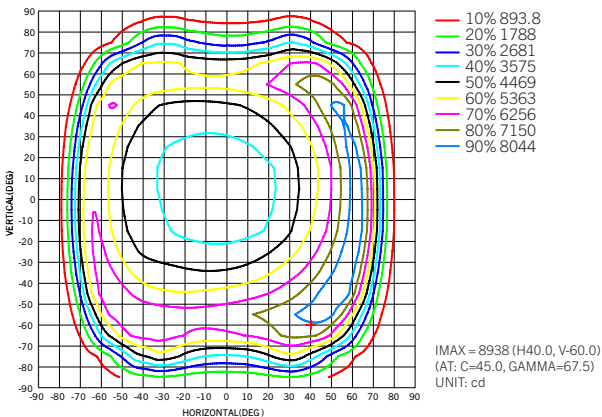

#### LUMINOUS INTENSITY DISTRIBUTION

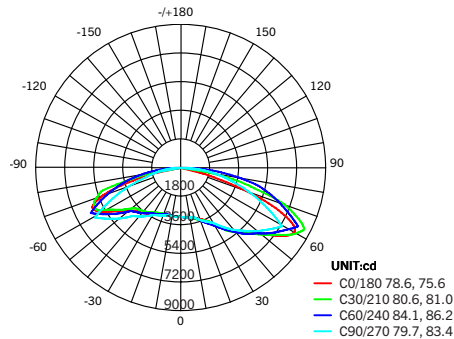

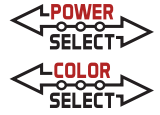











# KT-ALED290PS-L2-OSB-PMA-8CSB-VDIM-P

## POLE-MOUNT LED AREA LIGHT PREMIUM PACKAGE

### EPA SPECIFICATIONS

#### LARGE-SIZE FIXTURE HOUSING

- Conditions: Horizontal winds only for calculations. Worst case total projected area used for calculations.
- All drag coefficients are set as worst case 1.2.
- For details on exact EPA calculations and assumptions, please contact [productsupport@keystonetech.com](mailto:productsupport@keystonetech.com)

EPA Calcs (1.2*ft <sup>2</sup>   View)		Single Fixture	2 Fixtures at 90°	2 Fixtures at 180°	3 Fixtures at 90°	3 Fixtures at 120°	4 Fixtures at 90°	2 Fixtures Side-by-Side	3 Fixtures Side-by-Side	4 Fixtures Side-by-Side
Mounting Application	Fixture Position									
Adjustable Pole Mount 	Horizontal	0.62 sq. ft.	0.90 sq. ft.	1.24 sq. ft.	1.42 sq. ft.	1.48 sq. ft.	1.42 sq. ft.	0.74 sq. ft.	1.11 sq. ft.	1.48 sq. ft.
Adjustable Pole Mount 	45°	1.85 sq. ft.	2.43 sq. ft.	1.85 sq. ft.	3.01 sq. ft.	4.42 sq. ft.	3.01 sq. ft.	3.70 sq. ft.	5.55 sq. ft.	7.40 sq. ft.

# KT-ALED290PS-L2-OSB-PMA-8CSB-VDIM-P

## POLE-MOUNT LED AREA LIGHT PREMIUM PACKAGE

**ACCESSORIES (SOLD SEPARATELY)**

**SENSORS**

Factory-Installable OR Field-Installable (field-installable purchased separately)

✓	SUFFIX*	CATALOG NUMBER	DESCRIPTION	UPC	EASY CODE
	/MW3	KTS-MW3-12V-PKO	12V Microwave Occupancy Sensor	843654130637	TRM-32
	/FC3	KTSL-FC3-12V-PKO-PIR	Bluetooth mesh wireless Smart Port LED controller for SmartLoop system with integrated daylight and PIR motion sensor.	843654138862	OCW-60
	/FC4	KTSL-FC4-12V-PKO	Bluetooth mesh wireless screw-in low voltage fixture controller for SmartLoop system	843654149066	RUN-10



\* For factory installation of accessory, add suffix to fixture part number (see ordering examples and instructions on last page of spec sheet).

**Field-Installable / Field-Use ONLY (purchased separately)**

CATALOG NUMBER	DESCRIPTION	UPC	EASY CODE
KTS-MW3-REMOTECONTROL	Remote Control for KTS-MW3-12V-XX Sensors, Sets/adjusts all sensor performance parameters	843654132020	XSR-61



**LENSES**

**Field-Installable / Field-Use ONLY (purchased separately)**

CATALOG NUMBER	DESCRIPTION	UPC	EASY CODE
KT-ALED-LENS-L2-2CS-KIT	Type II Optics Lens for Color Select, Large Size Housing, Series 2 Area Lights	843654153858	HXC-12

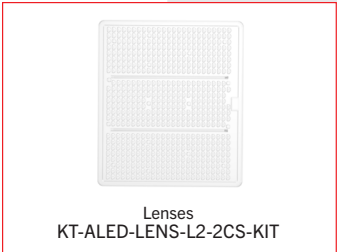

\* For factory installation of accessory, add suffix to fixture part number (see ordering examples and instructions on last page of spec sheet).



# KT-ALED290PS-L2-OSB-PMA-8CSB-VDIM-P

## POLE-MOUNT LED AREA LIGHT PREMIUM PACKAGE

**ACCESSORIES CONTINUED (SOLD SEPARATELY)**

### MOUNTS AND BRACKETS

Field-Installable / Field-Use **ONLY** (purchased separately)

CATALOG NUMBER	DESCRIPTION	UPC	EASY CODE
KT-ALED-GS-L2-KIT	Reversible Glare Shield for Large Size Housing, Series 2 Area Lights, Bronze	843654153810	RDW-18



*\* For factory installation of accessory, add suffix to fixture part number (see ordering examples and instructions on last page of spec sheet).*

### ORDERING INFORMATION

ORDER CODE	PACK QTY.	UPC	Easy Code
KT-ALED290PS-L2-OSB-PMA-8CSB-VDIM-P	1	843654153124	LWD-80

### CATALOG NUMBER BREAKDOWN

# KT-ALED290PS-L2-OSB-PMA-8CSB-VDIM-P

<b>1</b>	<b>2</b>	<b>3</b>	<b>4</b>	<b>5</b>	<b>6</b>	<b>7</b>	<b>8</b>	<b>9</b>	<b>10</b>	<b>11</b>	<b>12</b>	<b>13</b>	<b>14</b>	<b>15</b>
<b>1</b> Keystone Technologies	<b>2</b> Fixture Type	<b>3</b> LED Technology	<b>4</b> Max Wattage	<b>5</b> Power Select	<b>6</b> Size/Shape	<b>7</b> Style/Design Designation	<b>8</b> Optic Swap	<b>9</b> Optic Swap Designation	<b>10</b> Pole Mount Adjustable	<b>11</b> 80 CRI	<b>12</b> Color Select	<b>13</b> Color Select Designation	<b>14</b> 0-10V Dimming	<b>15</b> Stock Package

<b>9</b> Optic Swap Designation	B Type III lens installed, Type IV and V lens included
<b>13</b> Color Select Designation	B 3000/4000/5000K

### ORDERING EXAMPLES

FIXTURE WITH SINGLE FACTORY-INSTALLED ACCESSORY

**KT-ALED290PS-L2-OSB-PMA-8CSB-VDIM-P /7PRS**

KEYSTONE FIXTURE
CATALOG NUMBER
KT-ALED290PS-L2-OSB-PMA-8CSB-VDIM-P

FIXTURE WITH NO FACTORY-INSTALLED ACCESSORIES

**KT-ALED290PS-L2-OSB-PMA-8CSB-VDIM-P**

SENSORS		
✓	SUFFIX	CATALOG NUMBER
✓	/7PRS	KT-RSC-7PN

*\* When ordering more than one factory-installed accessory, use multiple suffixes as shown in the ordering examples above.  
 Note: All accessories can also be ordered separately for field installation using just their regular Catalog Number, UPC, or Easy Code.*



# KT-ALED290PS-L2-OSB-PMA-8CSB-VDIM-P

## POLE-MOUNT LED AREA LIGHT PREMIUM PACKAGE

### DESCRIPTION

290W Power and Color Select Optic Swap LED Area Light | 120-277V Input | Bronze Housing | Adjustable Pole Mount Kit Included

### APPLICATION

Pole-mount or structure-mount outdoor illumination needs (including parking lots, auto dealerships, pathways, roadways, recreational venues, and other general area lighting requirements)

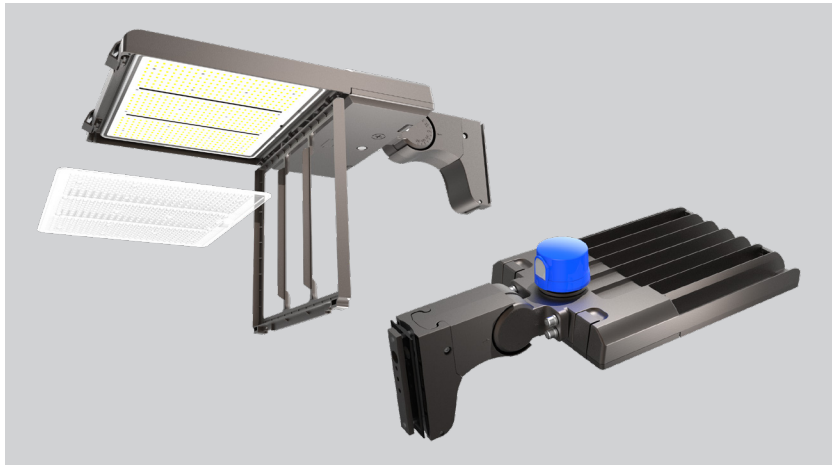

### PRODUCT FEATURES

- Keystone Power Select technology (290/210/185W)
- Keystone Color Select technology (3000/4000/5000K)
- Innovative optic swap capability under door frame and latch design for quick lens change
- Three lenses in the box: Type III installed, Types IV and V included
- Type II lens sold separately. See below for details
- Heavy duty die cast aluminum housing with ample heat sinking
- Low-profile design delivers high-performance illumination and improves application site aesthetics
- True U0 design for Dark Sky friendly performance that eliminates undesirable sky glow
- Integrated NEMA/ANSI C136.10 7-pin twist-lock receptacle with 3-pin photocell and shorting cap. Standard on all fixtures, simplifies ordering requirements for photo control needs
- Comes with a pre-installed adjustable pole mount kit for easy and quick mounting to square or round poles
- Keystone 0-10V dimming driver
- Ambient operating temperature: -40°C/-40°F to 50°C/122°F
- UL Certified, IP65 rated
- Power factor: > 0.95
- THD: < 20%
- LED chip lifetime: L70 > 100,000 hrs @ 25°C/77°F ambient fixture temperature
- Meets FCC Part 15, Part B, Class A standards for conducted and radiated emissions

### PRODUCT SPECIFICATIONS

Catalog No.	Wattage	CCT	Lumens	Efficacy	Input Voltage	Dimming	CRI	Distribution Pattern	Photocell Included	Housing Color	Legacy Equivalent
KT-ALED290PS-L2-OSB-PMA-8CSB-VDIM-P	290W	3000K	36320	125 lm/W	120-277V	0-10V	>80	Type III Installed, Types IV and V Included	Yes	Bronze	1000W MH
		4000K	42770	147 lm/W							
		5000K	38700	133 lm/W							
	210W	3000K	27300	130 lm/W							
		4000K	31710	151 lm/W							
		5000K	28980	138 lm/W							
	185W	3000K	22970	124 lm/W							
		4000K	27060	146 lm/W							
		5000K	24440	132 lm/W							

\* Fixtures with Type 2 (II) and Type 4 (IV) optics are available and assembled to order. Lead times may apply. Type II (2) lenses are sold separately. For more information, see accessories page below or contact Keystone with questions.  
 \*\*Fixtures (and mounts) with alternate housing colors are available and made to order. Extended lead times apply. Please see catalog number breakdown for full ordering code details.



# KT-ALED290PS-L2-OSB-PMA-8CSB-VDIM-P

## POLE-MOUNT LED AREA LIGHT PREMIUM PACKAGE

### PHYSICAL SPECIFICATIONS

#### POLE-MOUNT LED AREA LIGHT FIXTURE

Technical drawings of the pole-mount LED area light fixture. The top view shows a rectangular fixture with a width of 28.80" and a depth of 19.72". The height of the fixture is 13.97". The side view shows a depth of 3.01" and a height of 6.67".

PACKAGING	
Carton Quantity	1 piece
Carton Dimensions	5.63"H x 15.95"W x 26.18"L
Carton Weight	17.53 lbs

#### ADJUSTABLE POLE MOUNT KIT DRILLING HOLES

Technical drawings of the adjustable pole mount kit. The top view shows a rectangular plate with a width of 2.63" and a height of 6.69". The drilling holes are located at the following dimensions from the top-left corner: a hole with diameter  $\text{Ø}0.38"$  at 1.13" vertically; a hole with diameter  $\text{Ø}0.69"$  at 1.75" vertically; a hole with diameter  $\text{Ø}0.38"$  at 3.19" vertically; and a hole with diameter  $\text{Ø}0.38"$  at 5.50" vertically. The bottom view shows a depth of 2.25" and a width of 6.69".

Three 3D perspective views of the pole mount kit components: the top view, the side view, and the front view.

# KT-ALED290PS-L2-OSB-PMA-8CSB-VDIM-P

## POLE-MOUNT LED AREA LIGHT PREMIUM PACKAGE

### WIRING DIAGRAM

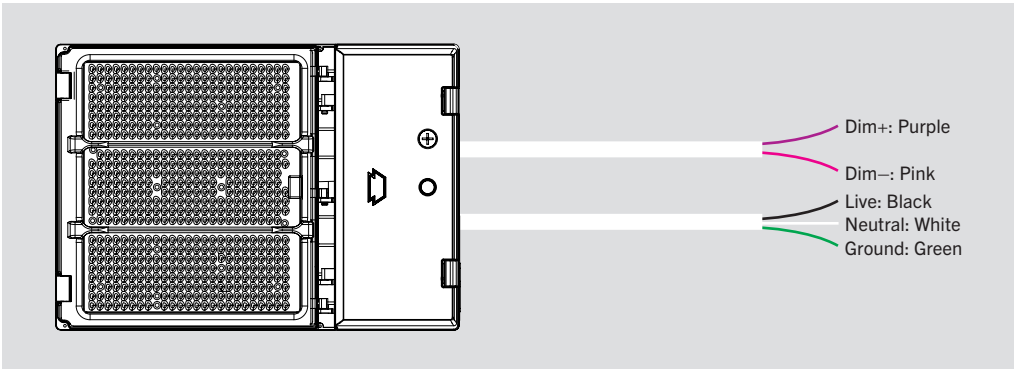

- This fixture comes pre-wired with a 7-pin twist-lock receptacle with shorting cap. Make input connections as needed and ensure connections are protected from exposure to the elements.
- **Input voltage rating: 120–277V**
- Ensure that input voltage on site matches the fixture you intend to install.

### POWER SELECT (WATTAGE) AND COLOR SELECT (CCT) ADJUSTMENT

This fixture is equipped with field-adjustable Keystone Power Select and Color Select technology.

1. Ensure power is off to the fixture.
2. Open the driver compartment located on the underside of the fixture.
3. Adjust switches to desired settings.

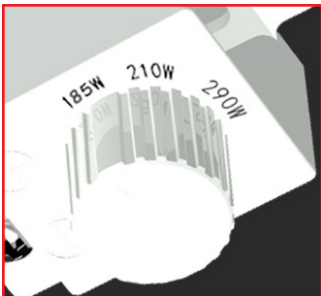

**POWER SELECT ADJUSTMENT DIAL**  
Set switch to adjust wattage between 290W, 210W, and 185W. Fixture comes preset at 290W.

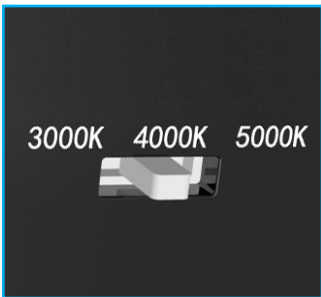

**COLOR SELECT ADJUSTMENT SWITCH**  
Set switch to adjust CCT between 3000K, 4000K, and 5000K. Fixture comes preset at 5000K.

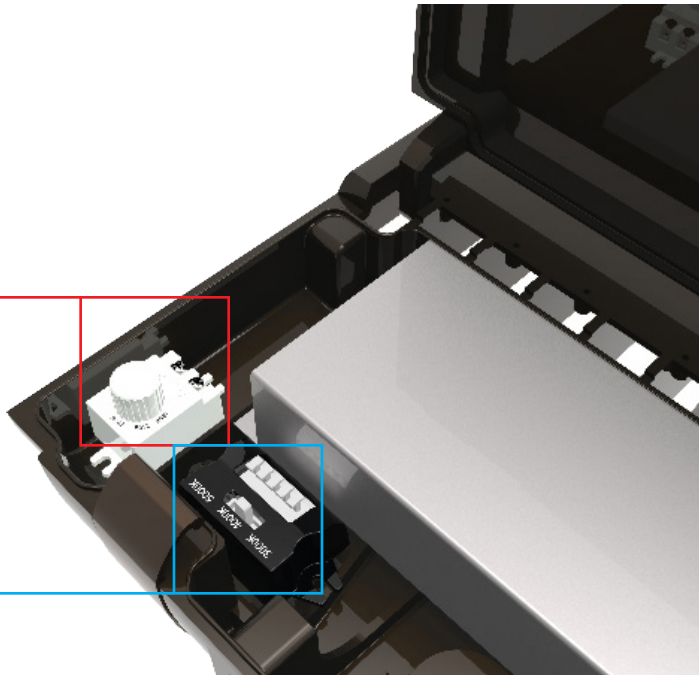

# KT-ALED290PS-L2-OSB-PMA-8CSB-VDIM-P

## POLE-MOUNT LED AREA LIGHT PREMIUM PACKAGE

**LIGHT DISTRIBUTION PATTERN**

**TYPE III (3)**

Pole mount view from above. Area light mounted at 30 ft. Each square is 10 ft x 10 ft

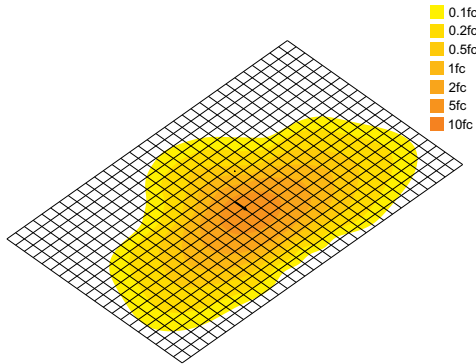

**TYPE V (5)**

Pole mount view from above. Area light mounted at 30 ft. Each square is 10 ft x 10 ft

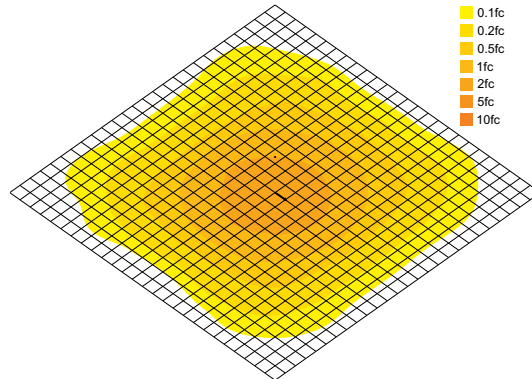

**PHOTOMETRIC SPECIFICATIONS (TYPE III [3])**

**ISOCANDELA PLOT**

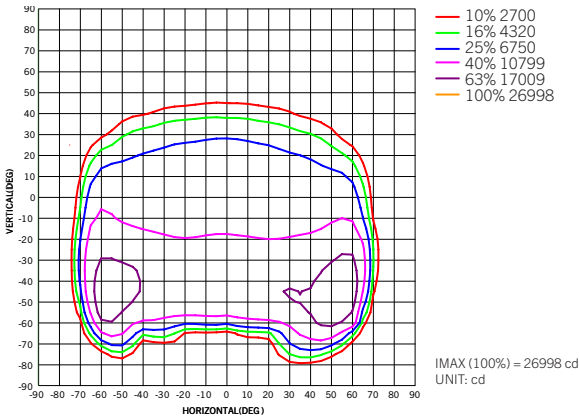

**LUMINOUS INTENSITY DISTRIBUTION**

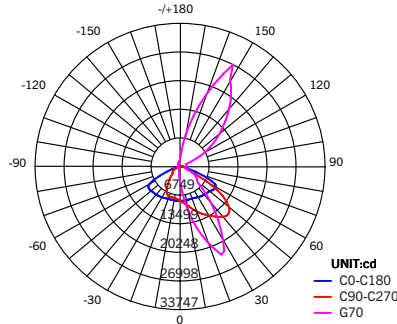

**PHOTOMETRIC SPECIFICATIONS (TYPE V [5])**

**ISOCANDELA PLOT**

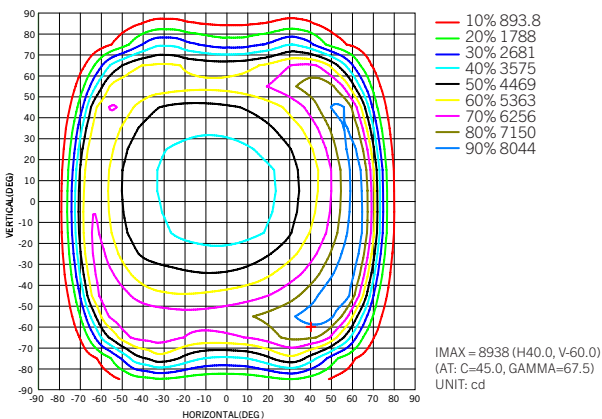

**LUMINOUS INTENSITY DISTRIBUTION**

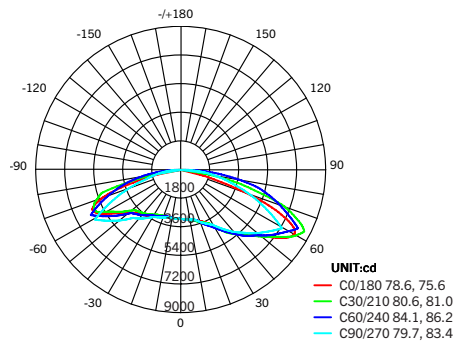













# KT-ALED290PS-L2-OSB-PMA-8CSB-VDIM-P

## POLE-MOUNT LED AREA LIGHT PREMIUM PACKAGE

### EPA SPECIFICATIONS

#### LARGE-SIZE FIXTURE HOUSING

- Conditions: Horizontal winds only for calculations. Worst case total projected area used for calculations.
- All drag coefficients are set as worst case 1.2.
- For details on exact EPA calculations and assumptions, please contact [productsupport@keystonetech.com](mailto:productsupport@keystonetech.com)

EPA Calcs (1.2*ft^2   View)		Single Fixture	2 Fixtures at 90°	2 Fixtures at 180°	3 Fixtures at 90°	3 Fixtures at 120°	4 Fixtures at 90°	2 Fixtures Side-by-Side	3 Fixtures Side-by-Side	4 Fixtures Side-by-Side
Mounting Application	Fixture Position									
Adjustable Pole Mount 	Horizontal	0.62 sq. ft.	0.90 sq. ft.	1.24 sq. ft.	1.42 sq. ft.	1.48 sq. ft.	1.42 sq. ft.	0.74 sq. ft.	1.11 sq. ft.	1.48 sq. ft.
Adjustable Pole Mount 	45°	1.85 sq. ft.	2.43 sq. ft.	1.85 sq. ft.	3.01 sq. ft.	4.42 sq. ft.	3.01 sq. ft.	3.70 sq. ft.	5.55 sq. ft.	7.40 sq. ft.

# KT-ALED290PS-L2-OSB-PMA-8CSB-VDIM-P

## POLE-MOUNT LED AREA LIGHT PREMIUM PACKAGE

**ACCESSORIES (SOLD SEPARATELY)**

**SENSORS**

Factory-Installable OR Field-Installable (field-installable purchased separately)

✓	SUFFIX*	CATALOG NUMBER	DESCRIPTION	UPC	EASY CODE
	/MW3	KTS-MW3-12V-PKO	12V Microwave Occupancy Sensor	843654130637	TRM-32
	/FC3	KTSL-FC3-12V-PKO-PIR	Bluetooth mesh wireless Smart Port LED controller for SmartLoop system with integrated daylight and PIR motion sensor.	843654138862	OCW-60
	/FC4	KTSL-FC4-12V-PKO	Bluetooth mesh wireless screw-in low voltage fixture controller for SmartLoop system	843654149066	RUN-10



\* For factory installation of accessory, add suffix to fixture part number (see ordering examples and instructions on last page of spec sheet).

Field-Installable / Field-Use ONLY (purchased separately)

CATALOG NUMBER	DESCRIPTION	UPC	EASY CODE
KTS-MW3-REMOTECONTROL	Remote Control for KTS-MW3-12V-XX Sensors, Sets/adjusts all sensor performance parameters	843654132020	XSR-61



**LENSES**

Field-Installable / Field-Use ONLY (purchased separately)

CATALOG NUMBER	DESCRIPTION	UPC	EASY CODE
KT-ALED-LENS-L2-2CS-KIT	Type II Optics Lens for Color Select, Large Size Housing, Series 2 Area Lights	843654153858	HXC-12

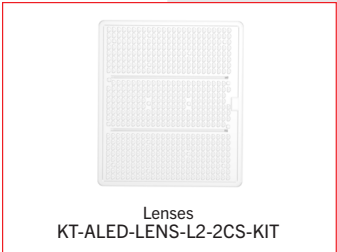

\* For factory installation of accessory, add suffix to fixture part number (see ordering examples and instructions on last page of spec sheet).



# KT-ALED290PS-L2-OSB-PMA-8CSB-VDIM-P

## POLE-MOUNT LED AREA LIGHT PREMIUM PACKAGE

**ACCESSORIES CONTINUED (SOLD SEPARATELY)**

### MOUNTS AND BRACKETS

Field-Installable / Field-Use **ONLY** (purchased separately)

CATALOG NUMBER	DESCRIPTION	UPC	EASY CODE
KT-ALED-GS-L2-KIT	Reversible Glare Shield for Large Size Housing, Series 2 Area Lights, Bronze	843654153810	RDW-18



\* For factory installation of accessory, add suffix to fixture part number (see ordering examples and instructions on last page of spec sheet).

### ORDERING INFORMATION

ORDER CODE	PACK QTY.	UPC	Easy Code
KT-ALED290PS-L2-OSB-PMA-8CSB-VDIM-P	1	843654153124	LWD-80

### CATALOG NUMBER BREAKDOWN

# KT-ALED290PS-L2-OSB-PMA-8CSB-VDIM-P

<b>1</b>	<b>2</b>	<b>3</b>	<b>4</b>	<b>5</b>	<b>6</b>	<b>7</b>	<b>8</b>	<b>9</b>	<b>10</b>	<b>11</b>	<b>12</b>	<b>13</b>	<b>14</b>	<b>15</b>
<b>1</b> Keystone Technologies	<b>2</b> Fixture Type	<b>3</b> LED Technology	<b>4</b> Max Wattage	<b>5</b> Power Select	<b>6</b> Size/Shape	<b>7</b> Style/Design Designation	<b>8</b> Optic Swap	<b>9</b> Optic Swap Designation	<b>10</b> Pole Mount Adjustable	<b>11</b> 80 CRI	<b>12</b> Color Select	<b>13</b> Color Select Designation	<b>14</b> 0-10V Dimming	<b>15</b> Stock Package

<b>9</b> Optic Swap Designation	B Type III lens installed, Type IV and V lens included
<b>13</b> Color Select Designation	B 3000/4000/5000K

### ORDERING EXAMPLES

FIXTURE WITH SINGLE FACTORY-INSTALLED ACCESSORY

**KT-ALED290PS-L2-OSB-PMA-8CSB-VDIM-P /7PRS**

KEYSTONE FIXTURE
CATALOG NUMBER
KT-ALED290PS-L2-OSB-PMA-8CSB-VDIM-P

FIXTURE WITH NO FACTORY-INSTALLED ACCESSORIES

**KT-ALED290PS-L2-OSB-PMA-8CSB-VDIM-P**

SENSORS		
<input checked="" type="checkbox"/>	SUFFIX	CATALOG NUMBER
<input checked="" type="checkbox"/>	/7PRS	KT-RSC-7PN

\* When ordering more than one factory-installed accessory, use multiple suffixes as shown in the ordering examples above.  
 Note: All accessories can also be ordered separately for field installation using just their regular Catalog Number, UPC, or Easy Code.