

MODELS AE50, AE80, AE110 INVENT™ SERIES FANS

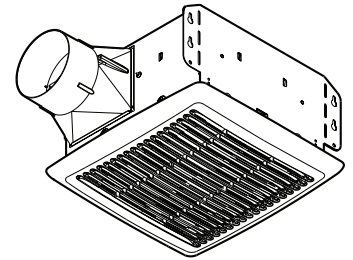

DESCRIPTION

BLOWER:

- Plug-in, permanently lubricated motor - engineered for continuous operation
- Dynamically balanced centrifugal blower wheel for quiet, efficient performance
- Low RPM for quiet operation

HOUSING:

- Rugged, 26 gauge, galvanized steel construction
- Polymeric, 4" duct connector with tapered sleeve and no metallic clatter
- 5-3/4" height allows for 2" x 6" ceiling installations
- Sturdy, easy, four-point mounting directly to joist
- Can be mounted in ceilings up to 7/12 pitch
- Can be installed in a wall if mounted 8-ft. or more above the floor

GRILLE:

- Polymeric construction
- Innovative design - the result of extensive research with designers and consumers

CONTROLS (Purchase separately):

- Refer to Broan's catalog for a complete line of accessories to effectively adapt these fans to your construction requirements.

U.L. Listed for use over bathtubs and showers when connected to a GFCI protected branch circuit (ceiling mount only).

U.L. Listed for use in insulated ceilings (TYPE I.C.)

3-Year Warranty - AE80, AE110

1-Year Warranty - AE50

TYPICAL SPECIFICATION

Fan shall be Broan Model AE50, (AE80), (AE110).

Fan shall have corrosion resistant galvanized steel housing with four-point mounting capability. It shall be ducted to a roof or wall cap using 4" round ductwork.

Blower assembly shall be removable, have a centrifugal-type blower wheel and a permanently lubricated motor designed for continuous operation.

Non-metallic damper/duct connector shall be included.

Air delivery shall be no less than the airflow values and no greater than the sound level values listed in the HVI Performance Specifications provided in this specification (see following chart). All air and sound ratings shall be certified by HVI.

Ceiling Ventilator shall be U.L. Listed for use in insulated ceilings (Type I.C.) and for use over bathtubs and showers when connected to a GFCI protected branch circuit.



Model AE80



Models
AE50, AE110



Broan Hartford, Wisconsin www.broan.com 800-558-1711

REFERENCE	QTY.	REMARKS	Project
			Location
			Architect
			Engineer
			Contractor
			Submitted by Date

PERFORMANCE RATINGS

INVENT™ SERIES FANS

HVI PERFORMANCE

Model	0.1 Ps - Static Pressure (in H2O)				0.25 Ps
	Airflow (CFM)	Sound (Sones)	Power (Watts)	Efficacy (CFM / W)	Airflow (CFM)
AE50	50	0.5	20.0	3.55	37
AE80	80	0.8	26.9	2.97	60
AE110	110	1.0	23.4	4.71	92



HVI-2100 CERTIFIED RATINGS comply with new testing technologies and procedures prescribed by the Home Ventilating Institute, for off-the-shelf products, as they are available to consumers. Product performance is rated at 0.1 in. static pressure, based on tests conducted in a state-of-the-art test laboratory. Sones are a measure of humanly-perceived loudness, based on laboratory measurements.

AIR FLOW PERFORMANCE

Model AE50



Model AE80

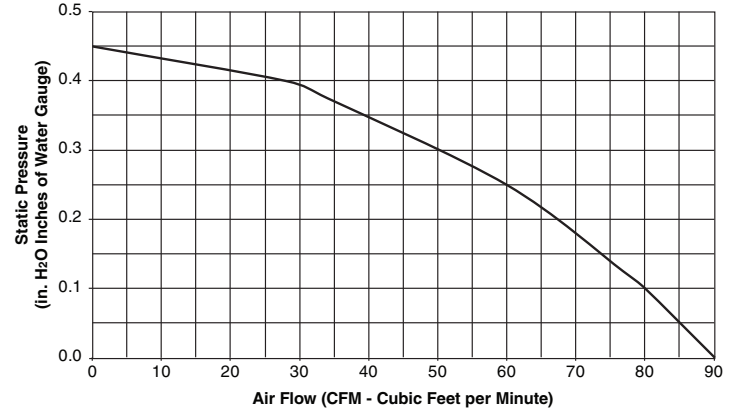

Model AE110

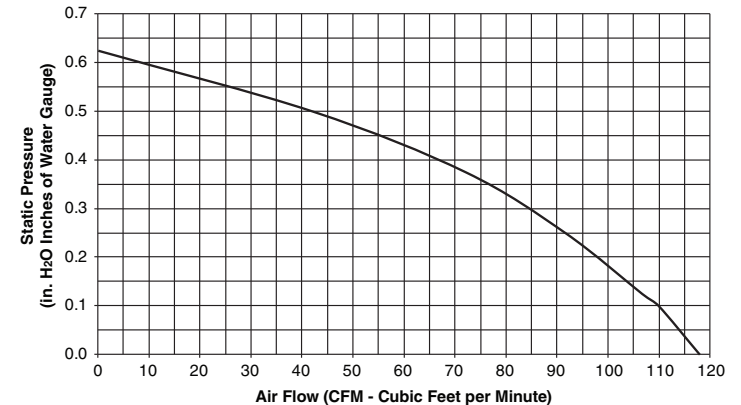

ELECTRICAL & WEIGHT

Model	Volts	Hz	Amps	Shipping Weight
AE50	120	60	0.2	10.0
AE80	120	60	0.3	10.0
AE110	120	60	0.3	10.0

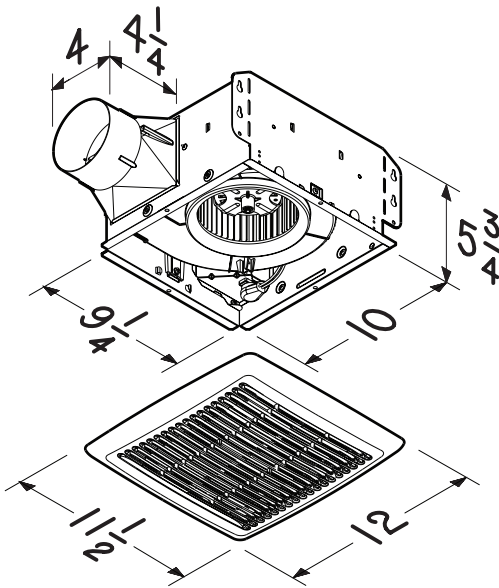

MODELS AE50, AE80, AE110 INVENT™ SERIES FANS

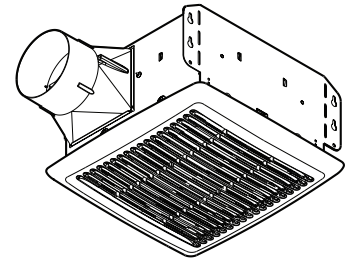

DESCRIPTION

BLOWER:

- Plug-in, permanently lubricated motor - engineered for continuous operation
- Dynamically balanced centrifugal blower wheel for quiet, efficient performance
- Low RPM for quiet operation

HOUSING:

- Rugged, 26 gauge, galvanized steel construction
- Polymeric, 4" duct connector with tapered sleeve and no metallic clatter
- 5-3/4" height allows for 2" x 6" ceiling installations
- Sturdy, easy, four-point mounting directly to joist
- Can be mounted in ceilings up to 7/12 pitch
- Can be installed in a wall if mounted 8-ft. or more above the floor

GRILLE:

- Polymeric construction
- Innovative design - the result of extensive research with designers and consumers

CONTROLS (Purchase separately):

- Refer to Broan's catalog for a complete line of accessories to effectively adapt these fans to your construction requirements.

U.L. Listed for use over bathtubs and showers when connected to a GFCI protected branch circuit (ceiling mount only).

U.L. Listed for use in insulated ceilings (TYPE I.C.)

3-Year Warranty - AE80, AE110

1-Year Warranty - AE50

TYPICAL SPECIFICATION

Fan shall be Broan Model AE50, (AE80), (AE110).

Fan shall have corrosion resistant galvanized steel housing with four-point mounting capability. It shall be ducted to a roof or wall cap using 4" round ductwork.

Blower assembly shall be removable, have a centrifugal-type blower wheel and a permanently lubricated motor designed for continuous operation.

Non-metallic damper/duct connector shall be included.

Air delivery shall be no less than the airflow values and no greater than the sound level values listed in the HVI Performance Specifications provided in this specification (see following chart). All air and sound ratings shall be certified by HVI.

Ceiling Ventilator shall be U.L. Listed for use in insulated ceilings (Type I.C.) and for use over bathtubs and showers when connected to a GFCI protected branch circuit.



Model AE80



Models
AE50, AE110



Broan Hartford, Wisconsin www.broan.com 800-558-1711

REFERENCE	QTY.	REMARKS	Project
			Location
			Architect
			Engineer
			Contractor
			Submitted by Date

PERFORMANCE RATINGS

INVENT™ SERIES FANS

HVI PERFORMANCE

Model	0.1 Ps - Static Pressure (in H2O)				0.25 Ps
	Airflow (CFM)	Sound (Sones)	Power (Watts)	Efficacy (CFM / W)	Airflow (CFM)
AE50	50	0.5	20.0	3.55	37
AE80	80	0.8	26.9	2.97	60
AE110	110	1.0	23.4	4.71	92



HVI-2100 CERTIFIED RATINGS comply with new testing technologies and procedures prescribed by the Home Ventilating Institute, for off-the-shelf products, as they are available to consumers. Product performance is rated at 0.1 in. static pressure, based on tests conducted in a state-of-the-art test laboratory. Sones are a measure of humanly-perceived loudness, based on laboratory measurements.

AIR FLOW PERFORMANCE

Model AE50

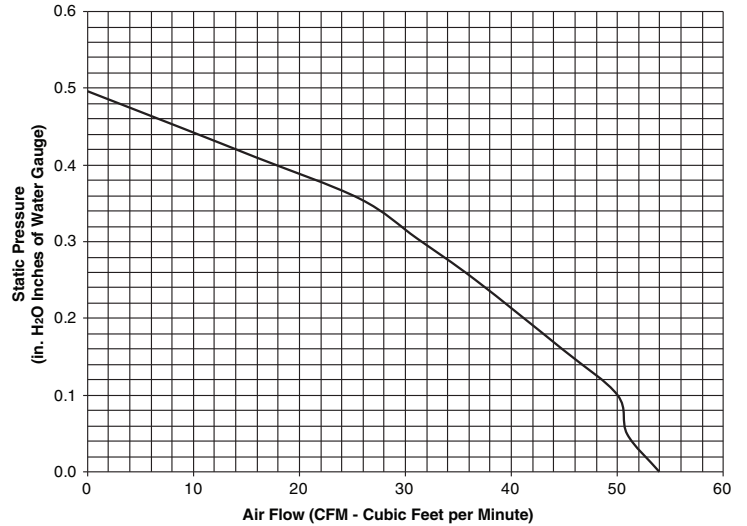

Model AE80

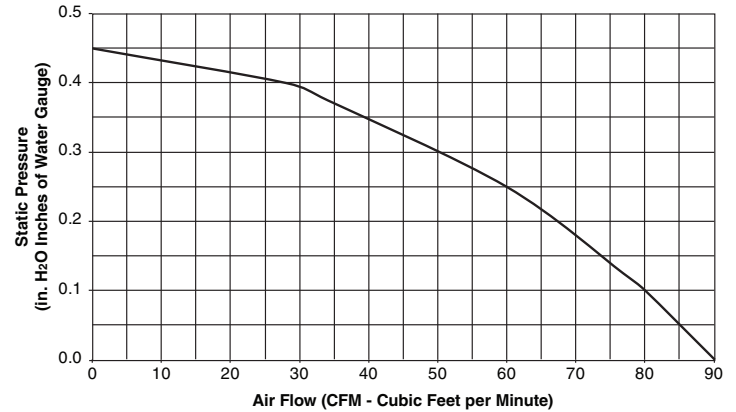

Model AE110

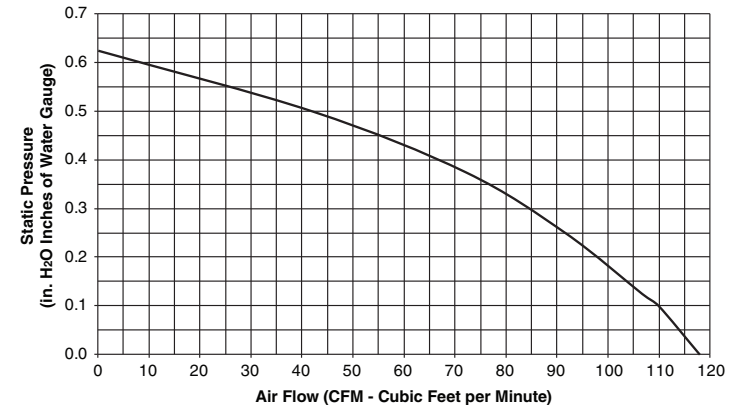

ELECTRICAL & WEIGHT

Model	Volts	Hz	Amps	Shipping Weight
AE50	120	60	0.2	10.0
AE80	120	60	0.3	10.0
AE110	120	60	0.3	10.0

