

Visit our website
www.idealindustries.co.uk



Wire Termination



Cable Installation



Lockout/Tagout



Test & Measurement



Datacom/
Network Testers



IDEAL

Electrical Catalogue

IDEAL INDUSTRIES LIMITED

Unit 3, Europa Court, Europa Boulevard, Westbrook, Warrington, WA5 7TN, U.K.
Tel.: +44 (0)1925 44 44 46 • Fax: +44 (0)1925 44 55 01 • Email: electrical.enquiries@idealnwd.com

For complete sales office contact information, visit us at:

www.idealindustries.co.uk

IDEAL, an American Original

We listen, and we deliver products with a purpose.

J. Walter Becker founded IDEAL in 1916 and made a promise that is still an important part of the way IDEAL operates today: "An IDEAL product will provide a value greater than the price paid for it. Service is a part of the product." Becker's founding principle represents our everyday commitment to you. It's the driving force behind our partnerships with the world's leading distributors, a state of the art delivery system, outstanding customer and technical support and variety of operational benefits designed to save time and money.

It means we're proud of the way we do business.

With headquarters located in Sycamore, Illinois, IDEAL also has European operations in the UK, Germany and France.

Today's global economy demands we look at doing business more creatively, more competitively and more efficiently. IDEAL is on the leading edge of product development and design, integrating those ideas through strategic investment, implementation of lean manufacturing and just-in-time inventory. Field-tested and customer influenced design means we are creating some of the most forward thinking product designs in the industry.



IDEAL is with you every step of the way

In-Sure™ & Twister® wire connectors, Yellow 77® wire pulling lubricant, T®-Stripper wire strippers, SignalTEK network testers and SureTrace® & TightSight® electrical testers are products which have found their way into the tool bags of electrical and networking professionals and solidified the IDEAL reputation as a manufacturer of innovative and trustworthy products.

Through ingenuity, proven performance and innovative engineering, IDEAL continues to lead the electrical industry with products that deliver value greater than the price paid for them.



TERMINATION TECHNOLOGY

Designed to exacting European safety standards, IDEAL manufactures a connector that's right for every job – fast, safe, reliable connections every time.



WIRE PULLING LUBRICANT

The No.1 brand of wire pulling lubricant. Environmentally safe, IDEAL lubes provide exceptional lubricity for super-fast cable pulls through conduit and ducting.



LOCKOUT/TAGOUT

IDEAL offers a comprehensive range of electrical lockout/tagout products that provide cost-effective solutions for managing electrical safety and circuit isolation.



TEST & MEASUREMENT

From our innovative SureTrace™ Circuit Tracers to the award winning TightSight® Clamp Meters, IDEAL develops test instruments that do the job faster, safer and easier.



DATACOM/ NETWORK TESTERS

From copper to fibre, twisted pair to coax, IDEAL offers everything you need for the installation, termination, testing and troubleshooting of modern LAN, CCTV and audio/video installations.

TABLE OF CONTENTS

A WIRE TERMINATION

In-Sure™ Push-In Wire Connectors	A-2
In-Sure™ Lever Wire Connectors	A-3
SpliceLine™ In-Line Wire Connectors	A-4
Twister® & WeatherProof® Wire Connectors	A-5
Wire Connector Kits	A-6

B CABLE INSTALLATION

Fish Tapes	B-2
Wire Pulling Lubricants	B-4
Duct Seal & Anti-Oxidant Compound	B-5
Conduit Benders	B-6
Wire Strippers	B-7
Cable Cutters	B-9
Quick Change Screwdriver	B-13
Hand Tools & Hack Saw	B-14

C LOCKOUT/TAGOUT

Lockout/Tagout Kits	C-2
Padlocks & Hasps	C-4
Lockout Devices	C-4
Lockout Devices & Accessories	C-6

D TEST & MEASUREMENT

Selection Guide & Safety	D-2
Clamp Meters	D-3
Multimeters	D-4
Voltage Testers/Light Meter	D-5
SureTrace™ Circuit Tracers	D-6
Digital Circuit Breaker Finder	D-8

E DATACOM/NETWORK TESTERS

LanTEK® III LAN Cable Certifiers	E-2
SignalTEK CT Cable Transmission Tester	E-3
SignalTEK NT Network Transmission Testers	E-4
NavITEK NT Network Troubleshooters	E-4
VDV II LAN Cable Verifiers	E-5
Fibre Optic Testers	E-6
SecuriTEST™ PRO CCTV Tester	E-7
Network Tester Accessories	E-7
Crimp Tools/Other Testers	E-8
Crimp Tools/Punch Down Tools	E-9
Compression Connectors	E-11
Coax Installation Kits	E-14
FT-45™ Modular Plug Crimp Tool	E-15
Feed-Thru and standard Cat 5e/Cat6 Modular Plugs	E-15
Cable Strippers	E-16
Data Cutter & Network Tester Accessories	E-17





NEW

NEW PRODUCTS FROM IDEAL

For almost 100 years IDEAL has served the electrical market and continues to take pride in innovation that delivers unrivalled value, quality and exceptional performance. Engineered specifically for the professional electrician, IDEAL is committed to providing new products that deliver durability, on the job efficiency and safety.

Every IDEAL product is covered by a comprehensive warranty.



NEW
Enhanced
Performance

SURETRACE™ CIRCUIT TRACERS

CertainCircuit™
After you identify and trip the correct breaker, the transmitter senses the loss of power and sends a different signal back to the receiver to give you confidence at the panel that the right circuit was de-energised.



Energised



De-energised



See Page D-6



InSITE
TECHNOLOGY

INSITE® COMPRESSION CONNECTORS

Featuring a 360° clear site window that simplifies the connector to cable installation.



NJX™ COMPRESSION CONNECTORS

offer a high performing, reliable and economical solution designed for applications that do not require weatherproof connectivity.



TLC™ COMPRESSION CONNECTORS,

our simplest, fastest and lowest total cost solution for installing compression connectors. Designed to save Time, Labour and Cost!



See Page E-11



VDV II TESTERS

- Three new Voice-Data-Video verification testers
- New test features including TDR length measurement, Ethernet service detection, PoE solicit and detect with voltage measurement, and more
- New multi remote and identifier accessory packs
- Visit www.vdvii.com for more details



See Page E-5

THERE'S A BETTER WAY TO CUT



Designed to cut 380 mm² (750 KCMIL MCM) and smaller hard-drawn copper and aluminium cables. The hardened steel blades ensure consistent cuts and long-term durability. The rounded blade design minimises cable distortion during cutting and the quick release mechanism simplifies blade back-out. The locking mechanism keeps handles closed for easy storage and the moulded-in foot provides stability and leverage when making multiple cuts.



See Page B-12

PowerBlade™ 750 CABLE CUTTER

With adjustable torque arms, heavy duty gears and state of the art hardened steel blades, IDEAL PowerBlade™ Cable Cutters offer ease of use and unsurpassed performance. The PowerBlade™ 750 is extremely versatile and designed for multiple applications. With a jaw opening of 38 mm (1.5") and specially hardened, rounded blades cable distortion is minimised for professional quality every time. This PowerBlade™ has the ability to cut up to 380 mm² (750 MCM) copper cable and 506 mm² (1000 MCM) aluminium cable.



See Page B-10

**POWERBLADE™ CUTS
COPPER CABLE UP TO
380 MM² (750 MCM)
AND ALUMINIUM UP TO
506 MM² (1000 MCM)**

**38 MM
1.5" MAX JAW
OPENING**



Connectors designed for every application

In-Sure™ Push-In Wire Connectors

The fastest, easiest, push-in connector on the market, the In-Sure™ push-in wire connector can reduce installation time by up to 50% compared to more traditional connection methods.

Our 2, 3 & 4 port connectors are uniquely rated to 32 Amps making them suitable for a broad range of wiring applications. In-Sure™ connectors are the perfect replacement for crimped splices.

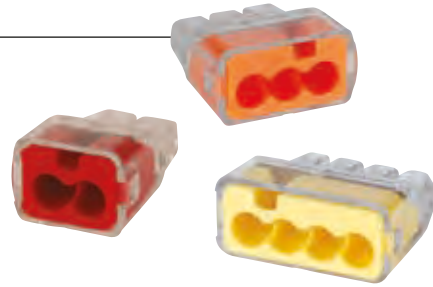

In-Sure™ Lever Wire Connectors

The new In-Sure™ lever wire connectors are the perfect solution for joining solid, stranded or flexible conductors. When used with rigid wires there is no need to touch the blue levers because they operate just like standard push-in connectors. Lifting the levers permits fast insertion of flexible wires and the removal of both flexible and rigid wires.

Suitable for use in a wide variety of installation and lighting applications these connectors are available in 2, 3 and 5-port variants that accommodate wires sizes up to 2.5 mm². Featuring a transparent housing that allows visual inspection of the wires and a compact design that takes up less room in junction boxes and enclosures, In-Sure™ lever wire connectors are the versatile all-rounders.

SpliceLine™ Wire Connector

SpliceLine™, a revolutionary in-line wire connector. Utilising patented push-in technology, the unique design provides a crimp-free, solderless butt splice making application easier and faster. The 2-port model supports a wide range of either stranded or solid wires, allowing one connector to cover the same wire range as multiple butt splices.

The end-to-end connection of SpliceLine™ is a great solution for today's pre-fab operations and also makes it perfect for lengthening short wires in tight spaces. It easily passes through standard knock-outs and the transparent polycarbonate allows for visual inspection, assuring a secure connection every time.



Twister® Wire Connectors

Accommodating the majority of common wiring configurations from 0.5mm² - 10.0 mm², the ribbed cap provides a secure grip and swept wings offer extra leverage. A patented square-wire spring provides safe, secure connections. Conforming to BS EN 60998 Twister® wire connectors fully comply with BS 7671:2008 (17th Edition Wiring Regulations).

A cost-effective and flexible solution, Twister® connectors are rated up to 57 Amps, will accept solid and stranded wire and have the added advantage of being re-usable, making them the obvious alternative to terminal blocks.

WeatherProof® Wire Connectors

Connected and Protected in one easy step. Designed specifically for above ground, interior/exterior connections exposed to damp/wet and corrosive environments.

Each connector is pre-filled with 100% silicone-based sealant which gives them their IP55 rating. Several models handle a variety of wire sizes from 1.5mm² - 4.0mm², making them ideal for use in gardens, garages and patio areas, as well as in commercial and industrial environments.



WIRE TERMINATION

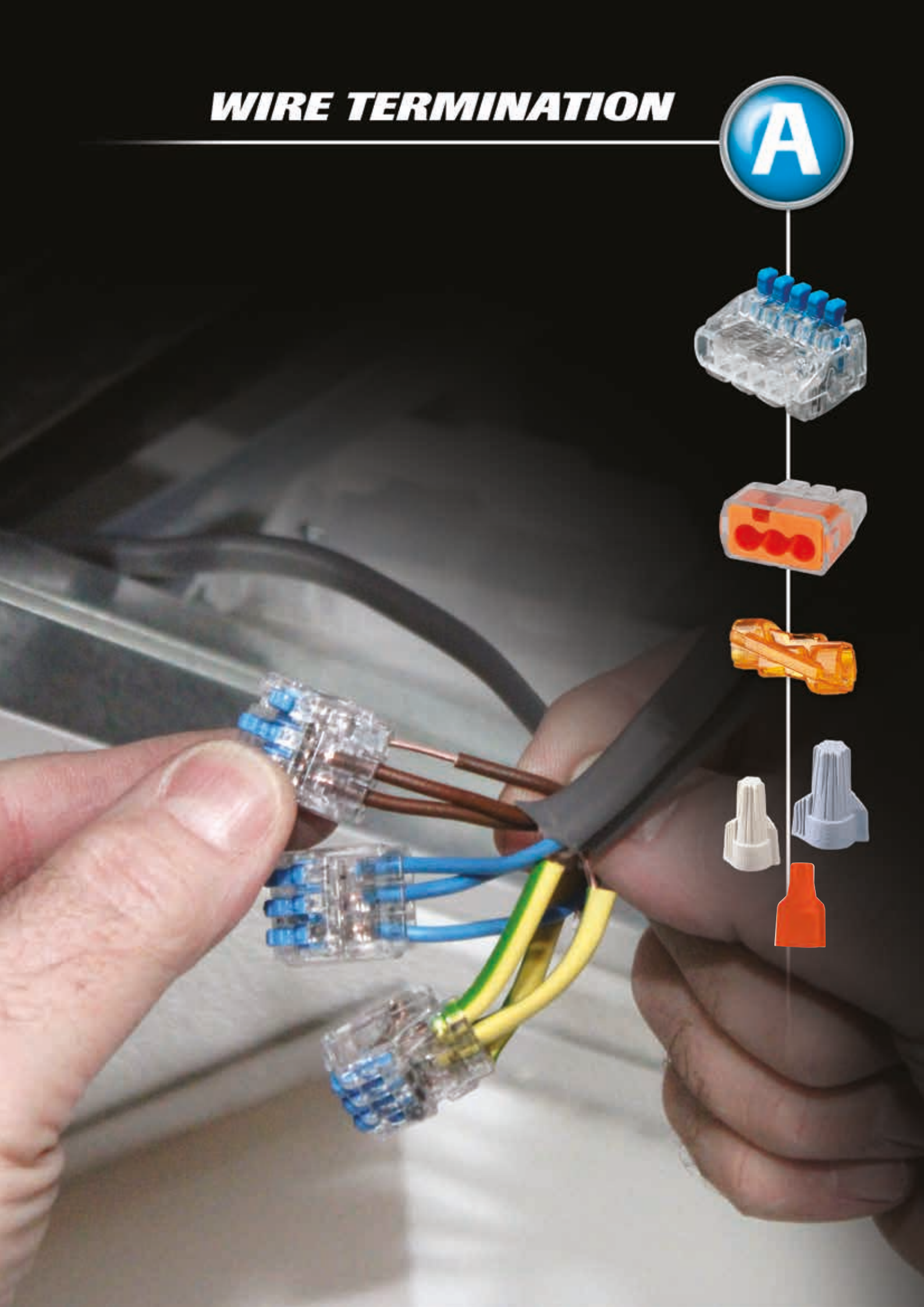

In-Sure® Push-In Wire Connectors

The In-Sure® push-in wire connector can reduce installation time by up to 50% compared to more traditional connection methods such as terminal blocks. In-Sure® connectors are the perfect replacement for crimped splices. In addition the most popular 2, 3 & 4 port models are rated to 32 Amps.

- Fits any combination of 0.75mm² - 4.0mm² solid or 1.5mm² - 2.5mm² stranded (≤ 7 strands) copper conductors or tin bonded flexible wire
- 32 Amp rating on 2, 3 and 4 port models
- High quality, secure connections
- Clear shell allows verification of connection
- Ergonomic design for easy grip and comfort
- Low insertion force for fast connections
- Continuity test port
- Colour coded for easy identification
- BS 7671:2008 (17th Edition) compliant
- Conform to EN 60998-1 and EN 60998-2-2 connecting device standards

Strip, Push, Connect
The Fastest Way To Make A Connection

Push-In

FAST FACT:

The In-Sure® Push-In has a low insertion force for fast, easy connections. Great for junction boxes.

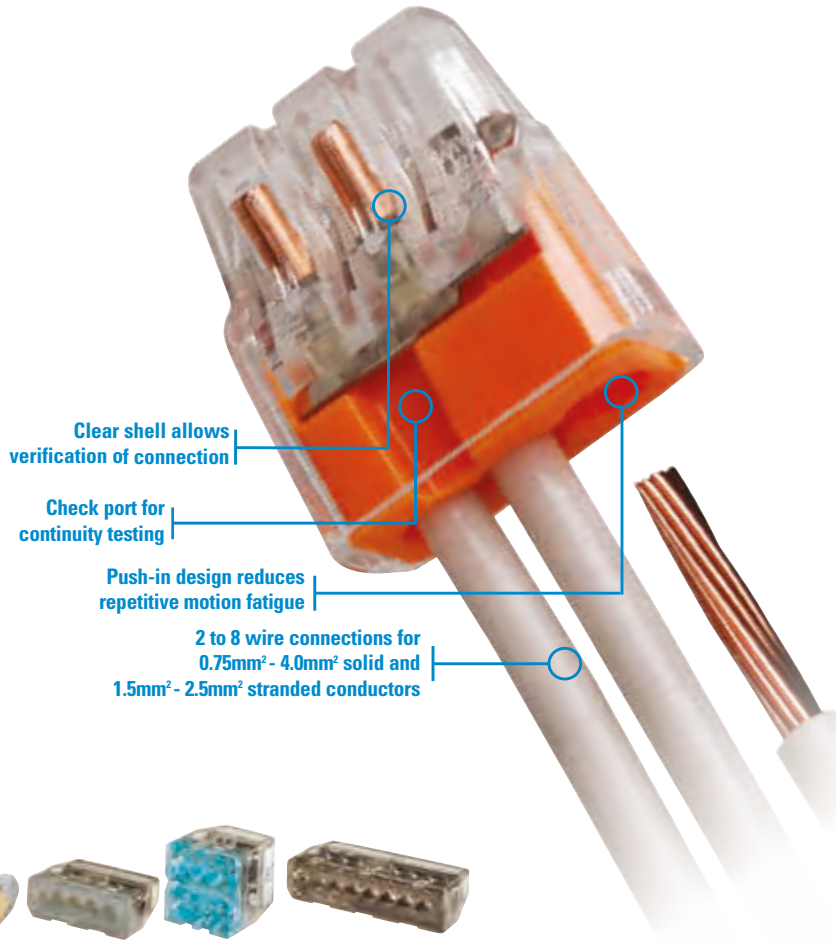

Specifications

	Model 32 Red 2-Port	Model 33 Orange 3-Port	Model 34 Yellow 4-Port	Model 87 Grey 5-Port	Model 88 Blue 6-Port	Model 90 Black 8-Port
Rating	32 Amp / 450V / 105°C maximum			24 Amp / 450V / 105°C maximum		
Depth	19.81 mm			18.52 mm	18.52 mm	18.21 mm
Width	13.21 mm	17.53 mm	20.83 mm	23.03 mm	15.32 mm	35.03 mm
Height	9.65 mm			9.02 mm	15.42 mm	9.02 mm
Wire Combination Range	Solid wire	0.75mm ² to 4.0mm ²			0.75mm ² to 4.0mm ²	
	Stranded wire*	1.5mm ² to 2.5mm ²			1.5mm ² to 2.5mm ²	

* Stranded wire is limited to ≤ 7 strand

Ordering Information

Model	Colour	Ports	Quantity	Cat. No.
32	Red	2	Box of 100	30-1032
33	Orange	3	Box of 100	30-1033
34	Yellow	4	Box of 100	30-1034
87	Grey	5	Box of 50	30-087
88	Blue	6 Stacked	Box of 50	30-088
90	Black	8	Box of 50	30-090

COPPER TO COPPER ONLY. Do not use on aluminium.



In-Sure® Lever Wire Connectors

The In-Sure® lever wire connectors provide the perfect solution for joining solid, stranded or flexible conductors.

These versatile connectors have a compact design that takes up less room in junction boxes and enclosures.

- Releasable connector for solid, stranded and flexible wires
- Wire clamping range: 0.2mm² – 2.5mm²
- Modern alternative to traditional strip connectors
- Safe, reliable and re-useable
- Works just like a standard push-in connector with solid and rigid stranded wires
- Clear shell allows verification of connection
- Continuity check port
- Strip length guide
- Compact design suits tight spaces
- No screwdriver required
- BS 7671:2008 (17th Edition) compliant
- Conform to EN 60998-1 and EN 60998-2-2 connecting device standards

Solid, Stranded or Flex The Versatile All-Rounder

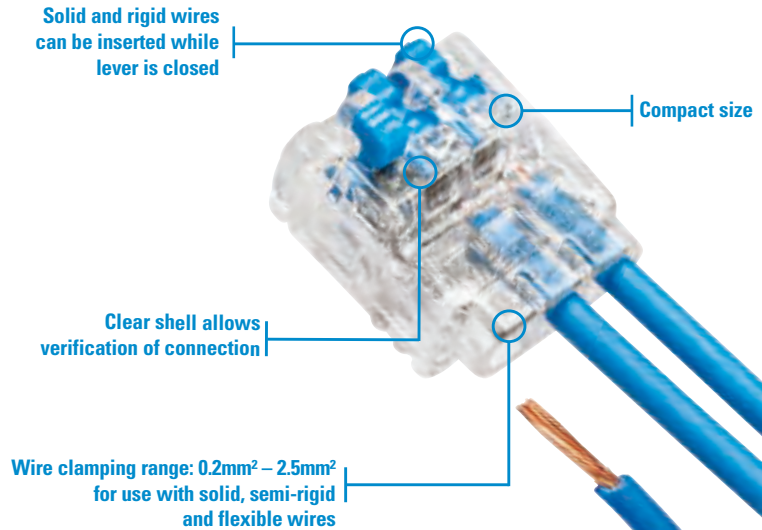

Lever

FAST FACT:

The In-Sure® Lever Connectors are ideal in lighting applications where you may have to join solid and flexible wires together.



Specifications

	Model 52 2-Port	Model 53 3-Port	Model 55 5-Port
Rating	24 Amp / 450V / 120°C		
Depth	21 mm		
Width	11.9 mm	16.1 mm	24.5 mm
Height	11.7 mm		
Wire Combination Range	Solid, Rigid Stranded and Flexible Wires		
	0.2mm ² -2.5mm ²		

Ordering Information

Model	Ports	Quantity	Cat. No.
52	2	Box of 40	30-1052
53	3	Box of 40	30-1053
55	5	Box of 30	30-1055
59	Mixed	Combo Box: 10 x 2-port 10 x 3-port 10 x 5-port	30-1059



SpliceLine® In-Line Wire Connectors

The SpliceLine® in-line wire connector provides a crimp-free, solderless butt splice. Conforming to BS 7671:2008, the two-port model accepts up to 4.0mm² solid wire, allowing one connector to do the job of multiple through-crimps. Its end-to-end connection is also a great solution for pre-fab operations.

- 32A rating
- Tool-free, push-in through crimp
- Easily passes through standard knockouts
- End-to-end connection ideal for pre-fab operations
- Transparent polycarbonate window for visual inspection of connection
- Wide wire range of: 0.5mm² to 4.0mm² solid
- BS 7671:2008 (17th Edition) compliant
- Conform to EN 60998-1 and EN 60998-2-2 connecting device standards

A Faster Butt Splice
A Better Butt Splice

Transparent polycarbonate shell allows for visual inspection of connection

Check port for continuity testing

Accepts solid or stranded* wire

Slim design fits through standard knockouts



Scan for product video

SpliceLine® IN-LINE WIRE CONNECTORS

FAST FACT:

Perfect for lengthening short wires, the SpliceLine® is 3X faster than traditional butt-splices.



Model	Colour	Rating	Wire Range	Quantity	Cat. No.
42	Orange	32A 450V 105°C	Solid: 0.5mm ² - 4.0mm ² Stranded*: 1.0mm ² - 2.5mm ²	Bag of 10	30-1342S
				Box of 100	30-1042

* Stranded wire is limited to ≤ 7 strands



Twister® Wire Connectors

The No.1 twist-on wire connector. The Twister® easily handles the most common wiring tasks. A patented, expanding square-wire spring always ensures a quick, safe connection.

- Exceptional wire-range capacity – three colour-coded models handle wire combinations from as small as 0.5 mm² to as large as 10.0 mm²
- Accept solid, stranded and flexible wires and are reusable
- Swept wings offer extra leverage and less effort for large wire combinations
- Live-action, square-wire spring locks onto wire for safe, secure connections
- Deep skirt helps protect against flash-over and turned-back strands for maximum dielectric protection
- Cost effective replacement for terminal blocks
- BS 7671:2008 (17th Edition) compliant
- Conform to EN 60998-1:2004, EN 60998-2-4:2005 connecting device standards

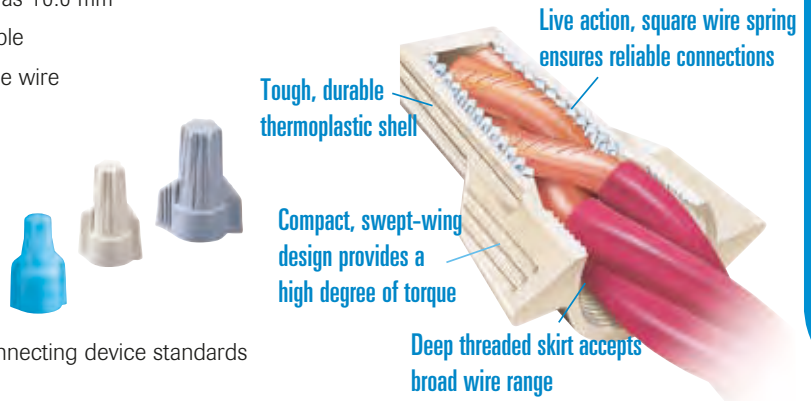

Wire Connectors

Optimum Wire Range

Ultimate Performance

Model	Colour	Wire Combination Range (mm)	Quantity	Cat. No.
340®	Lt. Blue	32A / 450V 0.5mm ² to 4.0mm ² Min. 2 x 0.5mm ² Max. 2 x 4.0mm ²	Box of 100	30-340
341®	Tan	41A / 600V 0.5mm ² to 6.0mm ² Min. 3 x 0.5mm ² Max. 2 x 6.0mm ²	Box of 100	30-341
342®	Grey	57A / 600V 2.5mm ² to 10.0mm ² Min. 3 x 2.5mm ² Max. 2 x 10.0mm ²	Box of 50	30-342
344®	Red/Yellow	32A / 600V 0.5mm ² to 4.0mm ² Min. 3 x 0.5mm ² Max. 4 x 4.0mm ²	Box of 50	30-144

Twister®

FAST FACT:

The small profile of the Model 340 Twister® means it easily fits inside standard connector enclosures.

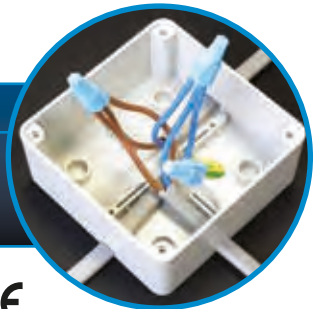

WeatherProof Wire Connectors

Designed specifically for above ground, interior/exterior connections exposed to damp/wet and corrosive environments.

WeatherProof connectors are pre-filled with a non-hardening, silicone-based sealant that protects against moisture and corrosion.

Connected and Protected

Damp/Wet Above Ground Locations

- Silicone-based sealant protects against moisture and corrosion
- IP55 rated for use in damp/wet locations
- Easy to apply, pre-filled twist-on wire connectors
- Accept solid and stranded wire
- Handle wire sizes from 1.5mm² to 4.0mm² copper conductors
- Tough, UL 94V-2 flame-retardant shell rated at 105°C (221°F)
- BS 7671:2008 (17th Edition) compliant
- Conform to EN 60998-1:2004, EN 60998-2-4:2005 connecting device standards



Model 61
24A/450V



Model 62
32A/450V



Model 63
32A/450V

WeatherProof

FAST FACT:

The silicone-based sealant protects electrical connections, eliminating the need for heat-shrink or water-proof enclosures in many applications.



WeatherProof Wire Connectors

Model	Colour	Wire Combination Range (mm ²)	Quantity	Cat. No.
61	Grey/Orange	1.5mm ² to 2.5mm ² Min. 1 x 1.5mm ² / Max. 2 x 2.5mm ²	Card of 25	30-1161
62	Grey/Red	1.5mm ² to 4.0mm ² Min. 2 x 1.5mm ² / Max. 4 x 4.0mm ²	Card of 20	30-1162
63	Grey/Dr. Blue	2.5mm ² to 4.0mm ² Min. 3 x 2.5mm ² / Max. 6 x 4.0mm ²	Card of 15	30-1163



Wire Connector Kits

IDEAL offers a range of wire connector kits comprising of In-Sure® Push-In, SpliceLine® In-Line, In-Sure® Lever Wire, Twister® and WeatherProof wire connectors.

These kits meet the needs of today's modern electricians who demand quality products that satisfy the requirement to make safe and reliable connections of wires in a variety of wiring applications.

Ordering Information for kits

Model	Description	Qty.	Cat. No.
	32A Push-In Connector Installer Kit	30 x 2-port push-in 30 x 3-port push-in 30 x 4-port push-in 30 x SpliceLine®	30-5011EU
	In-Sure® Push-In Connector Premium Kit	50 x 2-port push-in 50 x 3-port push-in 50 x 4-port push-in 40 x 5-port push-in 20 x 6-port push-in 15 x 8-port push-in 30 x Twister® 341 (FOC)	30-5020EU
	In-Sure® Push-In Connector Starter Kit	30 x 2-port push-in 30 x 3-port push-in 30 x 4-port push-in 20 x 6-port push-in	30-5021EU
	Push-In & Lever Wire Connector Kit (80 pcs.)	10 x 2-port lever connector 10 x 3-port lever connector 5 x 5-port lever connector 10 x 2-port push-in 10 x 3-port push-in 10 x 4-port push-in 10 x 6-port push-in 15 x 2-port SpliceLine®	30-5005EU
	Push-In & Lever Wire Connector Premium Kit (240 pcs.)	30 x 2-port lever connector 40 x 3-port lever connector 20 x 5-port lever connector 30 x 2-port push-in 30 x 3-port push-in 20 x 4-port push-in 15 x 5-port push-in 15 x 6-port push-in 10 x 8-port push-in 30 x 2-port SpliceLine®	30-5006EU
	Twister® & WeatherProof Connector Premium Kit	40 x Twister® 340® 40 x Twister® 341® 25 x Twister® 342® 25 x Twister® PRO 344® 20 x WeatherProof 61 12 x WeatherProof 62 12 x WeatherProof 63	30-5000EU
	Twister® & WeatherProof Connector Starter Kit	30 x Twister® 340® 30 x Twister® 341® 15 x Twister® PRO 344® 15 x WeatherProof 62	30-5001EU

CE

CABLE INSTALLATION

B



Tuff-Grip™ Pro... Industry's Leading Fish Tape!



**Length marked!
Now laser etched
in 12" increments
to provide instant
conduit length.**

Etched in (12") increments to provide instant conduit length.

Tuff-Cuff™ tape retaining feature keeps tape properly positioned in the opening.

Full-perimeter handle band helps keep dirt and moisture out, prolonging life.



Tuff-Grip™ Handle Large, comfortable ergonomically-designed, grasp from the top or side. Allows for use with gloves.

Superior pull-out and rewind characteristics.

Exceptionally Durable Case and Handle

Fish Tapes



Fish Tape Materials

Blued Steel™



- Laser etched in 12" increments to provide instant conduit length
- Unique finish is non-oily and resists rust
- Multiple options in width, length and eyelet for ease of use

- Industry's straightest wire
- Stiffer for long runs
- Highest grade carbon steel
- Tensile strength 725 kg (1,600 lbs.)

Zoom™

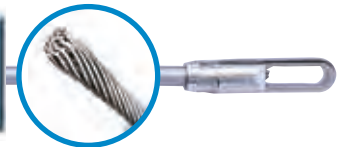

- 19 strands of stainless steel
- Ultra hard nylon jacket adds slipperiness, protects cables and user's hands
- Excellent for corrugated plastic conduit

19 strand twisted radial steel core encased in high molecular density outer jacket.

- Excellent for multiple bends or wet/corrosive work environment

Volt-Guard



- Non-conductive to 1000V
- Rectilinear profile for superior pushing power

- Designed for use around live circuits

Blued Steel™

Blued-Steel™ Fish Tapes

- Laser etched in 12" increments to provide instant conduit length
- High column strength for longer runs
- Non-oily finish resists rust

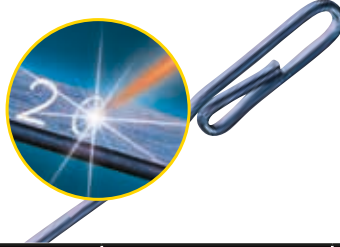

Length (m/ft.)	Width & Thickness mm / in	Case Diameter	End Type	Tuff-Grip™ Pro
Blued Steel™				
18 / 60	3.2 x 1.5 / 1/8 x .060	30 cm / 12 in.	Formed hook	31-055
36 / 120	3.2 x 1.5 / 1/8 x .060	30 cm / 12 in.	Formed hook	31-056
73 / 240	3.2 x 1.5 / 1/8 x .060	30 cm / 12 in.	Formed hook	31-057

Zoom™

Zoom™ Fish Tapes

- Great for hard to navigate conduit with multiple bends
- Nylon jacket protects the steel core while adding to the slipperiness of Zoom™

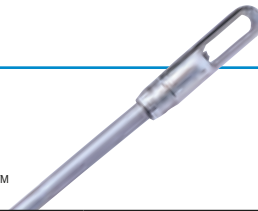

Length (m/ft.)	Width & Thickness mm / in.	Case Diameter	End Type	Tuff-Grip™ Pro
Zoom™ Nylon Jacketed Stainless Steel				
15 / 50	4.8 / 3/16 diameter	30 cm / 12 in.	Eyelet	31-090
30 / 100	4.8 / 3/16 diameter	30 cm / 12 in.	Eyelet	31-092

Volt-Guard

Volt-Guard Fish Tapes

- Non-conductive up to 1000V
- Elliptical design gives the Volt-Guard greater pushing power

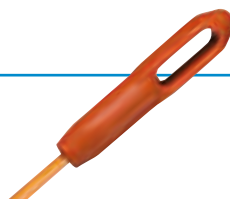

Length (m/ft.)	Width & Thickness mm / in.	Case Diameter	End Type	Tuff-Grip™ Pro
Fiberglass				
18 / 60	4.8 x 2.4 / .1875 x .094	30 cm / 12 in.	Eyelet	31-542
36 / 120	4.8 x 2.4 / .1875 x .094	30 cm / 12 in.	Eyelet	31-544

Aqua-Gel® II Cable Pulling Lubricant

- Polymer-based formula provides maximum tension reduction in high-stress electrical and communication cable-pulling operations
- Compatible with all cable types except composite rubber
- Cleans up easily with soap and water
- Clings to cable throughout long pulls
- Remains stable over wide temperature range – usable from -2°C to 88°C (28°F to 180°F)
- Dries to a semi-fluid film that won't clog conduit
- Easy to apply by hand, brush or pump
- Environmentally safe – non-toxic, non-flammable and non-corrosive
- Suitable for indoor or outdoor use



Description	Cat. No.
0.95 litre / 1-qt. Squeeze bottle	31-378

ClearGlide™ Wire Pulling Lubricant

- Clear and colourless for quick and easy clean-up – great for indoor and retrofit pulls
- Exceptional lubricity for super-fast pulls
- Polymer-based formula is perfect for all electrical and datacom applications
- Safe to use with all cable types
- Controlled evaporation rate is ideal for shorter runs
- Remains stable over wide temperature ranges – usable from -1°C to 82°C (30°F to 180°F)
- Dries to a semi-fluid film that won't clog conduit
- Easy to apply by hand, brush or pump
- Environmentally safe – non-toxic, non-flammable and non-corrosive



Description	Cat. No.
0.95 litre / 1-qt. Squeeze bottle	31-388

Wire Pulling Lubricant Selection Guide



	ClearGlide™ Wire Pulling Lubricant	Yellow 77® Wire Pulling Lubricant	Aqua-Gel® II Wire Pulling Lubricant
Colour	Clear	Yellow	Blue
Base	Polymer	Wax	Polymer
Average Coefficient of Friction*	0.23	0.17	0.19
Pull Length Up To	75 ft/22 m	1,200 ft/365 m	250 ft/76 m
Retains Pull Characteristics Up To	8 hours	24 hours	24 hours
Stability Range	32°F – 180°F (0°C – 82°C)	32°F – 130°F (0°C – 54°C)	32°F – 180°F (0°C – 82°C)
Application Temperature Range	40°F – 100°F (4°C – 38°C)	40°F – 100°F (4°C – 38°C)	40°F – 100°F (4°C – 38°C)
COMPATIBILITY (Cable Types):			
Rubber	•	•	•
Neoprene	•	•	•
Nylon	•	•	•
PVC	•	•	•
High-density or Cross-linked Polyethylene	•	•	•
Low-density Polyethylene	•	•	•
Semiconducting Jacket	•	•	•
Hypalon	•	•	•

*Results from NEETRAC, an independent testing laboratory affiliated with The Georgia Institute of Technology.

Yellow 77® Wire Pulling Lubricant

The no. 1 brand of wire pulling lubricant since 1959.

- The perfect general purpose lube
- Wax-based formula provides superior lubricity
- Safe to use with most cable types except low-density polyethylene and semi-conducting jackets
- Clings to cable throughout long pulls, even where moisture is present
- Won't break down or separate after repeated exposure to freezing temperatures
- Dries to a thin, non-conductive film
- Easy to apply by hand or brush
- Creamy texture applies easily and uniformly
- Homogeneous blend requires no mixing
- Won't dry out – surface coat forms to control evaporation
- Environmentally safe – non-toxic, non-flammable and non-corrosive



Description	Cat. No.
0.95 litre / 1-qt. Squeeze bottle	31-358
3.79 litre / 1-gal. Bucket	31-351
18.93 litre / 5-gal. Bucket	31-355

Duct Seal

- Seals around junction boxes, flashings and service entrances
- Permanently soft, non-toxic compound can be painted immediately after application
- Won't adversely affect other plastic materials or corrode metals



Description	Cat. No.
0.45 kg / 1 lb. Block	31-601
2.27 kg / 5 lb. Block	31-605

Selection & Application Guide



Web Based Selection & Application Guide:
<http://ideal.sdafiles.com>

Noalox® Anti-Oxidant

- Anti-oxidant and anti-seizing compound improves efficiency and service life of aluminium-to-aluminium and aluminium-to-copper electrical connections
- Suspended zinc particles penetrate and cut aluminium oxide
- Provides additional inter-strand and inter-conductor current paths for improved conductivity and cooler connections
- Carrier material excludes air to prevent further oxidation
- For use with all types of pressure-type wire connectors including screw-on, tap, service entrance and split-bolt
- Reduces galling and seizing and promotes good ground continuity on aluminium conduit joints



Description	Cat. No.
15 ml / 0.5 oz. Tube	30-024
118 ml / 4-oz. Squeeze bottle	30-026

For a Material Safety Data Sheet on Noalox® and other products check out:

<http://www.idealindustries.co.uk/support/msds/>



Duct Seal/Anti-Oxidant

Conduit Benders

- Exceptionally durable materials for extra strength
- Reinforced at stress points for longer life
- Markings are raised and cast into the bender body on both sides for easy visibility
- Deeply serrated step helps prevent slippage when applying force
- Grooved internal hook surface helps prevent conduit from slipping
- Flat hook surface provides stable starting point
- Much lower cost than stand mounted benders
- Takes up minimal space in vehicle
- Simple to use with no set-up required



Ductile Iron

- Withstands a lifetime of heavy use
- Ductile iron material is stronger than malleable iron or aluminium



Ductile Iron Head & Handle Complete

Conduit Type and Size	Cat. No.
20 mm / 3/4 in. steel conduit	74-027
25 mm / 1 in. steel conduit	74-028

Ductile Iron Head Only

Conduit Type and Size	Cat. No.
20 mm / 3/4 in. steel conduit	74-002
25 mm / 1 in. steel conduit	74-003



Handles for Benders

- Rugged, steel construction for long-term durability
- Baked-on blue enamel finish resists corrosion and enhances visibility
- Convenient bending guide for offset bends

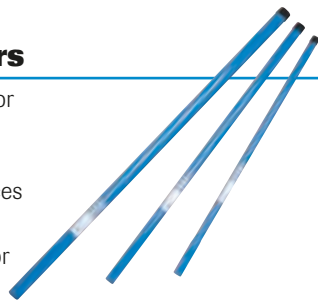

Conduit Type and Size	Cat. No.
20 mm / 3/4 in. steel conduit	74-019
25 mm / 1 in. steel conduit	74-020

BenderBoot™

- Santoprene® tread and hand grip provides support for saddle and offset bends
- Easy push-on assembly to 1/2 in. and 3/4 in. bender handles



Description	Cat. No.
BenderBoot™	H-4076

Santoprene® is a registered trademark of Exxon Mobil



Scan for product video

T[®]-Stripper Wire Strippers

Invented by IDEAL INDUSTRIES and manufactured at our facility in Sycamore, Illinois, USA, the T[®]-Stripper Wire Stripper line has been the industry standard for almost 50 years.

Compact, lightweight and easy to use. Features precision-ground, knife-type blades, built-in looping holes, wire cutters and a convenient plier nose.



- Form-ground, knife-type blades for accurate, easy stripping without nicking insulation
- Built-in wire cutter and looping holes
- Convenient plier nose for extra gripping strength
- Laser-etched wire gauge for easy-to-read visibility
- Spring-loaded automatic opening
- Corrosion-resistant, black oxide finish
- Tough steel construction

Description	Solid	Stranded	Cat. No.
T [®] -Stripper Wire Stripper – Metric	0.75-6.0mm ²		45-120-341
T [®] -Stripper Wire Stripper – Metric	0.5-4.0mm ²		45-125-341

Lil' Ripper Stripper™

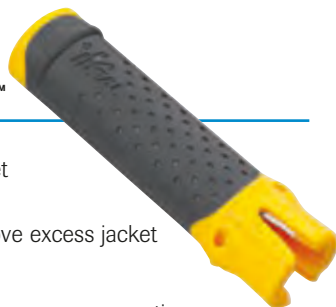

- Rips Twin & Earth outer jacket cleanly and quickly
- Clips outer sheathing to remove excess jacket
- Strips inner conductor wires
- Looping holes loop wire for screw-on connections
- Twist-Assist™ tightens most popular sizes of winged twist-on connectors
- Injection moulded elastomer grip provides a comfortable, slip resistant grip
- Strip length measuring scale allows for quick and easy measurements
- Conveniently fits in your pocket

Description	Cat. No.
Lil' Ripper Stripper™	45-025

Reflex™ Premium T[®]-Stripper Wire Strippers



- Ergonomic design for maximum comfort
- Curved handles reduce wrist fatigue
- Sleeves extend to stripping head to cushion thumb and fingers
- Textured, no-slip sleeves provide a sure, easy grip

Description	Solid	Stranded	Cat. No.
Reflex™ Premium T [®] -Stripper – Metric	0.5mm ² -4.0mm ²		45-425-341

7-in-1 Stripper



- Versatile, seven-function tool features precision-ground stripping blades, cushioned grips and plier nose
- Strips 1.5mm² - 6.0mm² solid and 0.5mm² - 4.0mm² stranded wire (AWG equivalents)
- Crimps bare and insulated terminals from 0.5mm²-5.0mm² wire, RG-59 coax connectors and 7 to 8mm auto ignition connectors
- Cuts unhardened wire, bolts and screws and reforms threads
- Reams and de-burrs conduit
- Gauges and loops wire

Description	Cat. No.
7-in-1 Stripper	45-777

Premium Insulated T[®]-Stripper Wire Stripper

The IDEAL insulated T[®]-Stripper creates a perfect blend of safety, comfort and precision functionality. Featuring double insulated Santoprene[®] handles with a soft, easy-to-grip outer surface, the insulated coating process acts as an 'at-a-glance' safety check. If the orange outer coating reveals any of the inner yellow surface, an electrician will know that this tool needs to be replaced.

- 1000 Volt certified (1000V AC, 1500V DC)
- Meets IEC 60 900 and ASTM F1505-01 standards
- Double insulated handles for added safety
- Form-ground, knife-type blades for accurate, easy stripping without nicking insulation
- Built-in wire cutter and looping holes
- Convenient plier nose for extra gripping strength
- Laser-etched wire gauge for easy-to-read visibility
- Spring-loaded automatic opening
- Corrosion-resistant, black oxide finish
- Locking tabs keep spring in place

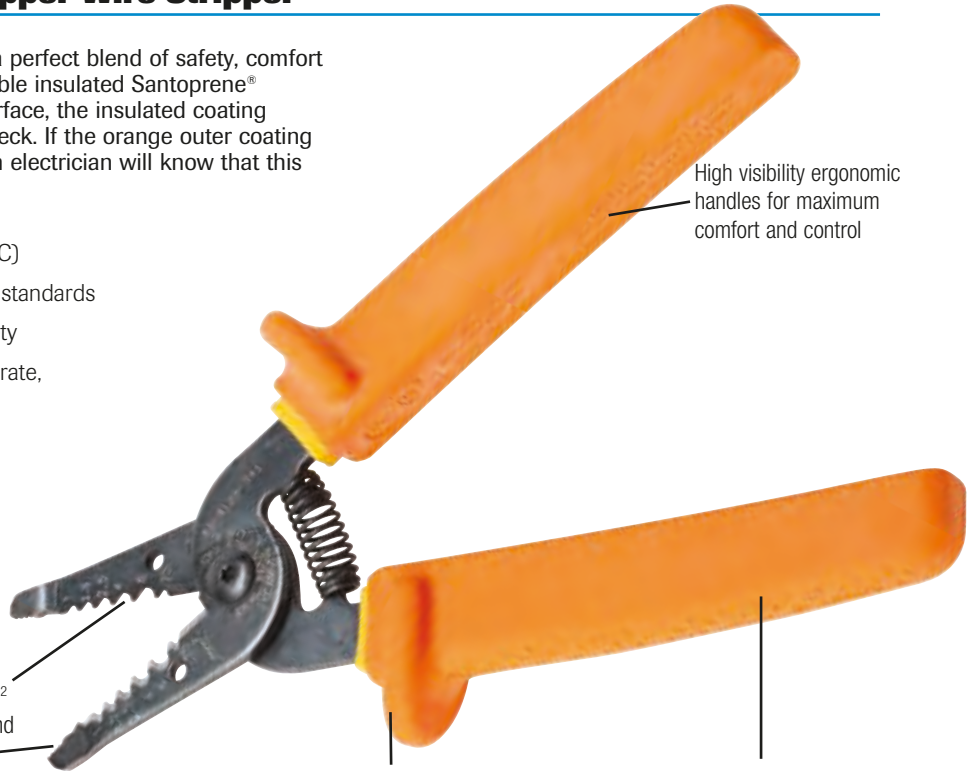

High visibility ergonomic handles for maximum comfort and control

0.75mm² to 6.0mm² stripping notches and plier gripping nose

Non-slip guard for added safety

Textured handles provide a sure grip and are resistant to perspiration, water, oil and chemicals

Description	Cat. No.
Premium T [®] -Stripper Wire Stripper - Metric 0.75mm ² -6.0mm ²	45-9120-341

Stripmaster[®] Wire Stripper

- One-step stripping enhances productivity
- Spring-action motion increases leverage and reduces operator fatigue
- Precision-ground, knife-type blades provide clean, accurate stripping
- Sturdy die-cast frame provides long-term durability
- Wire gripper holds wire securely in position



Knife-Type Blades for Metric Wire

Wire Size mm ²						Cat. No.
0.75 mm ²	1.0 mm ²	1.5 mm ²	2.5 mm ²	4.0 mm ²	6.0 mm ²	45-292-341

Twin & Earth Cable Stripper



- Self-adjusting stripping blades automatically select proper position
- Strips Twin and Earth cable
- Open-throat construction allows unlimited strip length
- Neatly removes outer cable sheath and inner wire sheathing to desired lengths
- Lightweight, ergonomic design reduces user fatigue

Description	Cat. No.
Twin & Earth Cable Stripper	45-235

T[®]-Cutter Wire Cutter



- Hardened steel, sheer-type blades
- Spring-loaded automatic opening
- Convenient plier nose for extra gripping strength
- Corrosion-resistant, black oxide finish
- Tough steel construction
- Locking tab keeps spring in place

Description	Cat. No.
T [®] -Cutter Wire Cutter	45-123

Long-Arm Cable Cutter



- High strength forged blades for ultimate durability
- Precision-ground jaws make clean cuts with minimal cable distortion
- Replaceable blades
- 1000 MCM (29.3 Dia.)
- For copper and aluminium only

Description	Length	Cat. No.
Long-Arm Cable Cutter	810 mm/32"	35-033

CAUTION: Comfort-grip handles are not designed for protection against electrical shock. Do not use on live circuits.

Data T[®]-Cutter Wire Cutter



- Cuts round communication cable and maintains cable geometry for better cable performance
- Cuts multi-pair cable up to 12.7 mm (0.5 in.) and coaxial cable up to RG-9/U
- Suitable for soft cables (not steel reinforced)
- Steel reinforced centre conductors can be trimmed with bolt cutting holes
- Cushioned comfort grip handles
- Locking latch keeps tool closed in pouch

Description	Cat. No.
Data T [®] -Cutter	45-074

PowerBlade™ Cable Cutter

The IDEAL PowerBlade™ Cable Cutter is designed to cut cables quickly and efficiently. With adjustable torque arms, heavy-duty gears and proprietary hardened steel blades, they deliver unsurpassed performance, ease-of-use and durability. Compatible with virtually any 12 volt or higher drill so that cutting is as effortless as pulling the drill's trigger. The unique compact design is the perfect tool for fitting into tight spaces. Features an ergonomic design and non-slip grips, helping you cut cable easily and safely.

Description	Cat. No.
PowerBlade™ 750 Cable Cutter	35-078

Not designed to cut SWA cable.

Cable Cutters



Scan for product video

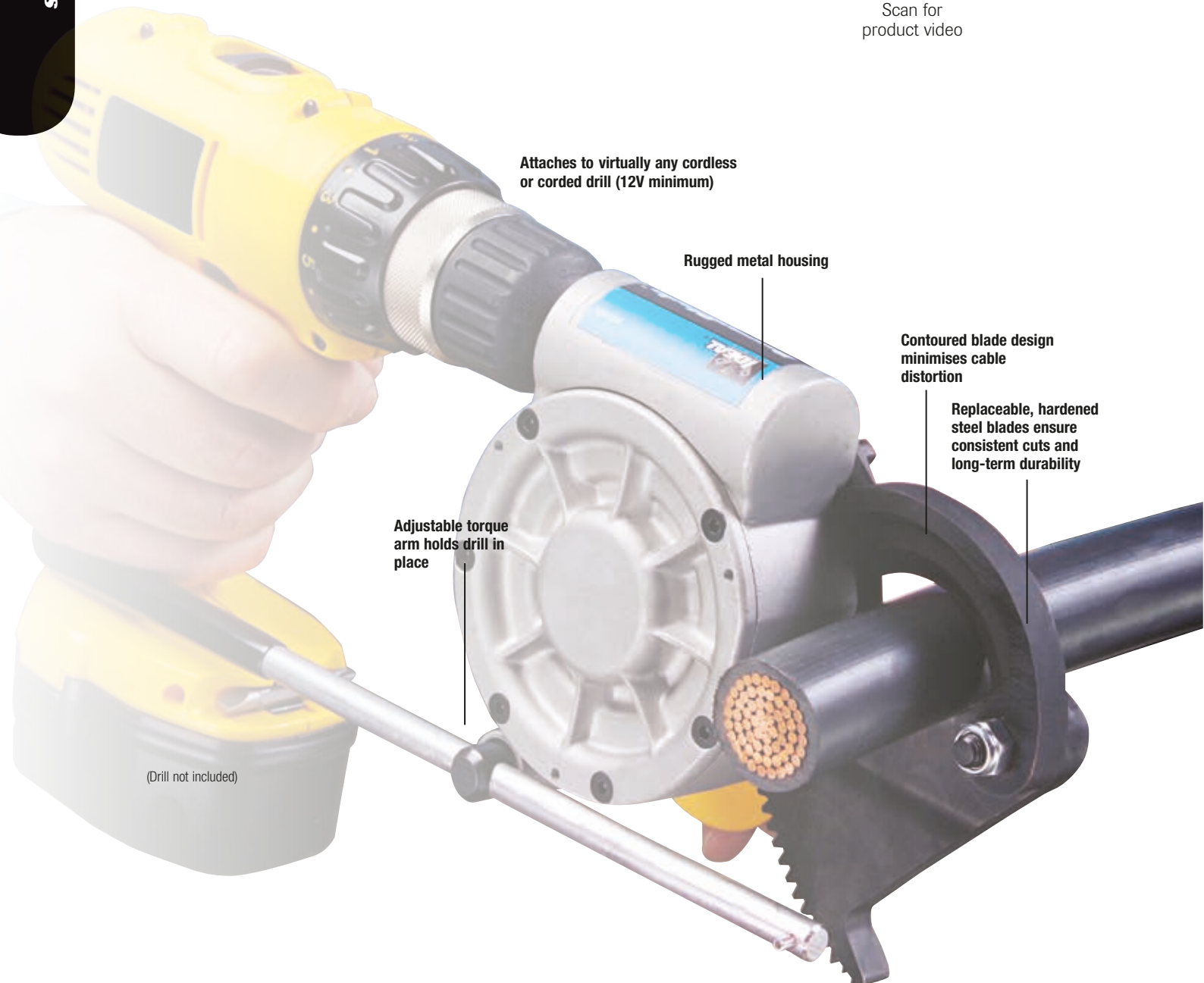

Attaches to virtually any cordless or corded drill (12V minimum)

Rugged metal housing

Contoured blade design minimises cable distortion

Replaceable, hardened steel blades ensure consistent cuts and long-term durability

Adjustable torque arm holds drill in place

(Drill not included)

PowerBlade™ 750 CABLE CUTTER



(Drill not included)

- Extremely versatile and designed for multiple applications
- Jaw opening of up to 1 1/2 inch (38mm).
- Cuts copper cable up to 380 mm² (750 MCM) and aluminium cable up to 506 mm² (1000 MCM)
- Specially hardened, rounded blades minimise cable distortion for professional quality every time



Cable Cutters

38 MM (1 1/2")

MAX JAW OPENING



Ratcheting Cable Cutter

- Designed to cut 380 mm² (750 KCMIL MCM) and smaller hard-drawn copper and aluminium cables
- Hardened steel blades ensure consistent cuts and long-term durability
- Rounded blade design minimizes cable distortion during cutting
- Quick release mechanism simplifies blade back-out
- Locking mechanism keeps handles closed for easy storage
- Moulded-in foot provides stability and leverage when making multiple cuts

Not designed to cut SWA cable.

Cable Cutters

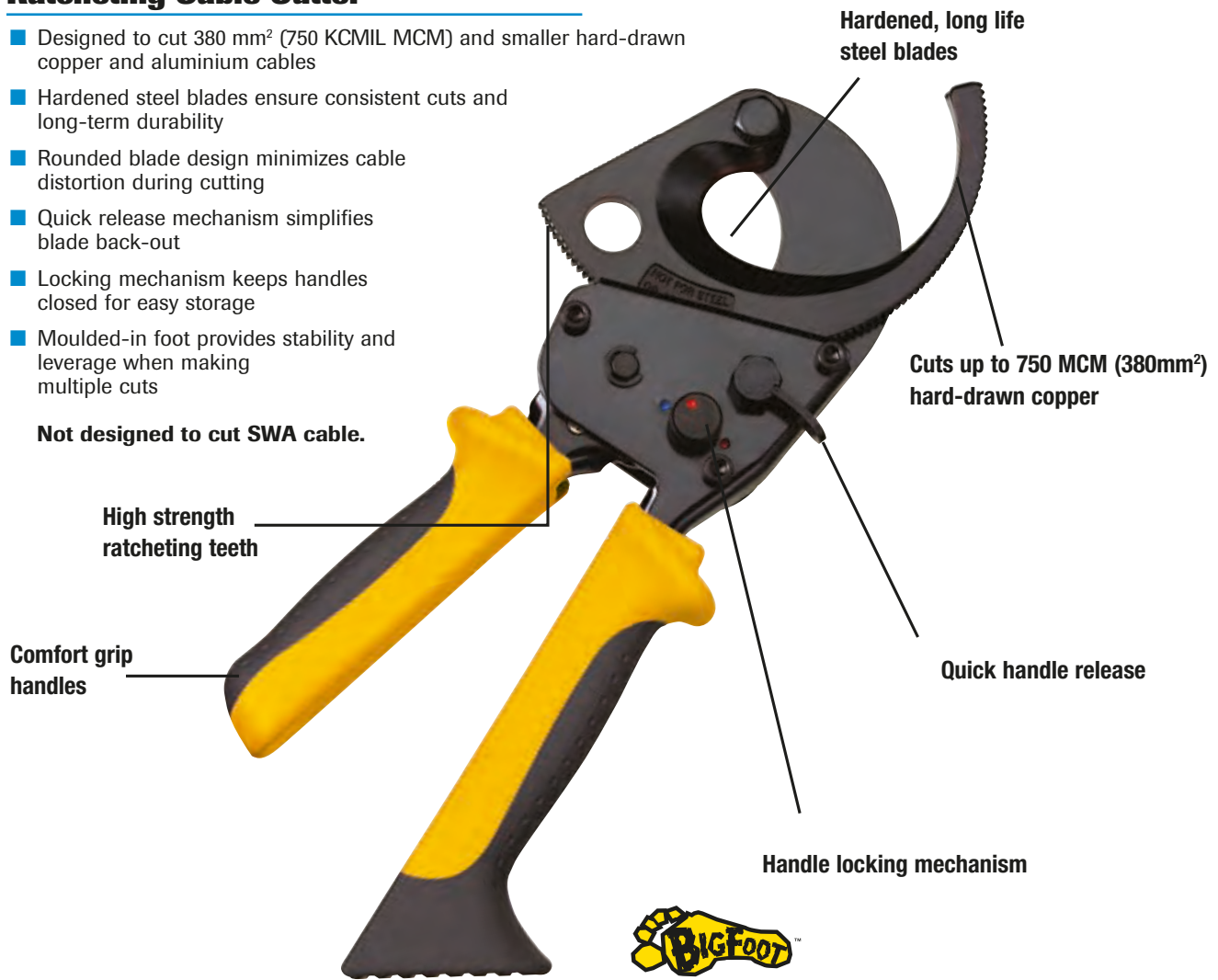

Description	Cat. No.
750 KCMIL (MCM) Ratcheting Cable Cutter*	35-053

*Max. Jaw Opening - 2 in. (50mm). Not for SWA cable.



Quick Change Screwdriver

The Quick Change Screwdriver is the ultimate multi-bit tool. Simply insert any standard bit into the socket or use as a 1/4" nutdriver. To switch to a different bit, pull back the gold knurled collar, remove the bit, and snap in another. This tool is as durable as it is useful. The driver blade has been coated in black oxide for superior corrosion resistance, and heat treated for optimum strength. Include this in your tool box as the most versatile screwdriver you will ever need!

- Patented Sure-Loc™ Quick Change chuck eliminates debris pick up as well as dropped bits
- Built-in bit storage container in handle holds up to five extra insert bits
- Bits fit all standard multi-bit screwdrivers
- E-Z Spin™ high torque rotating flip cap
- Patented design



Screwdriver

Replacement Bits

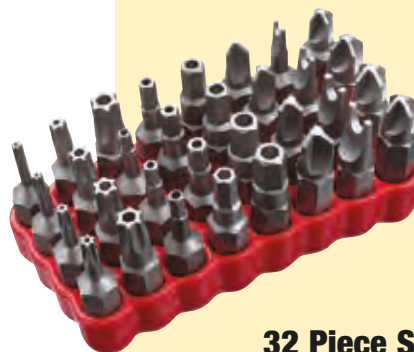

32 Piece Tamper-Proof Bit Block

32 commonly used tamper-proof bits in one portable block

32 Piece Standard Bit Block

Includes the patented Combo Head™ bit



(Excludes Bits)

The Quick Change Screwdriver accommodates a variety of bits



Scan for product video

Description	Blade Length	Handle Length	Overall Length	Cat. No.
33-Piece Quick Change Screwdriver Set - Quick Change Screwdriver and 32-Piece Tamper-Proof Bit Block	3-1/16 in.	4-3/16 in.	7-1/4 in.	35-933
33-Piece Quick Change Screwdriver Set - Quick Change Screwdriver and 32-Piece Standard Bit Block	3-1/16 in.	4-3/16 in.	7-1/4 in.	35-934

Auto-Lock™ Tape Measure 7.5m/25ft



- Automatic blade lock
- Push button for smooth blade retraction
- Nylon coated blade for extra long life and wear resistance
- Double sided marked blade for convenience
- Shock-resistant rubber grip for added comfort and protection

Description	Cat. No.
Auto-Lock™ Tape Measure 7.5m/25ft	35-242M

Safe-T-Grip® Fuse Puller

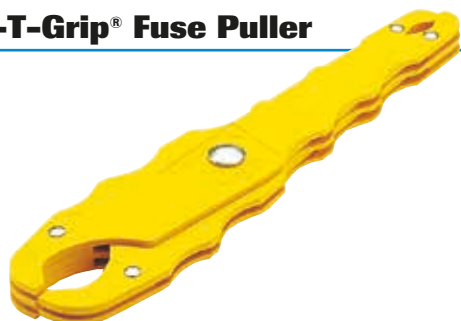

- Maximum efficiency and convenience for removing or replacing cartridge-type fuses
- Fully insulated, high-dielectric, glass-filled polypropylene construction
- Notched handles provide safe, no-slip grip
- Clearly marked amperage ranges
- Exceed MIL specifications

Description	Cat. No.
Medium Puller for 0 to 100A/250V & 600V, 1.3 cm (1/2 in.) to 2.5 cm (1 in.) dia. fuses; 19 cm (7-1/2 in.) long	34-002

Heavy-Duty Hacksaw

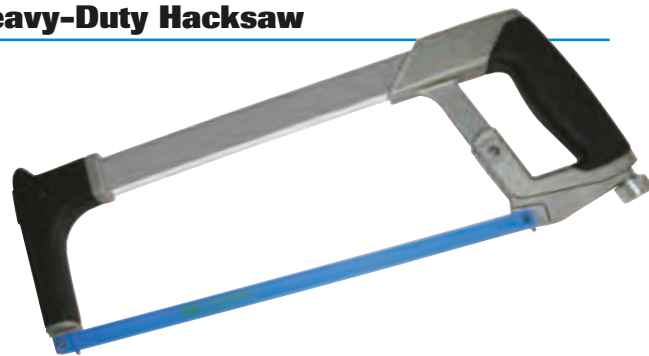

- Cushioned ergonomic grip for performance and comfort
- Rugged frame provides lightweight rigidity and exceptional control
- Stores up to nine extra blades
- Blades can be adjusted to 55° angle for flush cutting and tensioned to 30,000 psi
- Includes 300 mm / 12 in. x 24T bi-metal blade

Description	Cat. No.
Heavy-Duty Hacksaw	35-260

Ratchet Crimp Tool



- Crimps insulated or bare terminals and splices on 0.5mm² - 4.0mm² (10-22 AWG) wire
- Ratchet action prevents release prior to crimp connection – helps ensure uniform crimps
- Vinyl-coated handles provide a solid, comfortable grip

Description	Cat. No.
Ratchet Crimp Tool	83-001

Large Mouth Bag



- Top opens completely for easy access to large tools – reinforced to hold itself open
- Rugged zipper closure helps prevent tool loss
- Removable shoulder strap
- Durable multi-ply construction

Description	Cat. No.
Large Mouth Bag - 330 mm / 13 in. long	35-410

Note: Tools are not included.

LOCKOUT/TAGOUT



DANGER

DO NOT OPERATE

This lock / tag may only be removed by:

Name: _____

Company: _____

Contact No.: _____

Completed Completion: _____

Part # 44-833EU

Importance of Safe Isolation

Unintentional energisation of circuits, machinery and equipment is a leading cause of death and injury among electrical contractors in the UK.

To minimise this type of accident regulations such as the “Provision and Use of Work Equipment 1998, Section 19 Energy” and the “Electricity at Work Regulations 1989, Regulation 13” require companies to have effective isolation policies in place.

Most accidents can be avoided by installing simple lockout / tagout devices prior to any electrical work being carried out.

Basic Practice for Safe Isolation

When working on electrical equipment / energized circuits, it is important that certain basic steps are followed:

- The correct point of isolation is identified
- An appropriate means of isolation is used
- Suitable caution notices should be placed where visible at the point of isolation
- All conductors must be proved to be dead at the point where work is intended to be carried out
- The electrical supply can not be reinstated while work is being carried out on any equipment / part of the circuit
- Isolation of equipment / circuits should be under the control of the person responsible for carrying out work on the isolated conductors
- Multi-lock hasps / devices should be used in the event of more than one person working on isolated equipment / circuits



IDEAL offers a range of lockout / tagout products to provide a cost-effective and safe solution in the management of electrical safety and circuit isolation in the workplace.

IDEAL lockout/tagout devices help to achieve compliance with current regulations.

For more comprehensive information on electrical safety and safe isolation, refer to the best practice guide available from the Electrical Safety Council entitled ‘Guidance on the **management of electrical safety and safe isolation** procedures for **low voltage installations**’. The latest version is available on the Electrical Safety Council website (www.esc.org.uk).

Kit Selection Chart

Part number	Description:	44-925	44-924	44-985UK	44-995
K-8334	Safety Padlock	✓	✓	✓	
K-40611	Non-Conductive Safety Padlock				✓
KB-0224	Steel Lockout Hasp		✓	✓	
44-428EU	Non-Conductive Lockout Hasp				✓
KB-0375	Circuit Breaker Lockout			✓	✓
IA-2280	“No-Hole” Lockout Device			✓	✓
441.001	MCB Pins-Out Device (Std)	✓	✓	✓	✓
441.002	MCB Pins-In Device				✓
441.003	MCB Pins-Out Device (Wide)				✓
441.004	Tie-Bar Lockout Device				✓
KB-0234	Universal MCB Lockout Device (Metal)	✓	✓	✓	✓
44-2393	Universal MCB Lockout Device (Plastic)				✓
44-2394	Universal MCB Lockout Device (Plastic)				✓
44-833EU*	Lockout Tags	✓ (1)	✓ (2)	✓ (5)	✓ (5)
KB-7566	Marking Pen		✓	✓	✓
IA-3240	Lockout Pouch		✓	✓	✓

* Available to order in packs of 5 (44-5833EU)

Contractor Lockout/Tagout Kit

- Aimed at contractors working on industrial, commercial and domestic installations
- Contains a range of devices allowing you to lock off most breakers on the market
- Supplied in a handy zipped pouch to help keep the kit close to hand and easily accessible



Description	Cat. No.
Contractor Lockout/Tagout Kit	44-985UK

Contractor PRO Lockout/Tagout Kit

- Aimed at contractors working on industrial, commercial and domestic installations
- Contains a broad range of devices allowing installers to provide safe isolation by locking off virtually all breakers on the market today
- Includes full range of MCB lockout devices including pins-in, pins-out, pins-out wide, tie-bar and various universal MCB lockout devices
- Supplied in a handy zipped pouch to help keep the kit close to hand and easily accessible



Description	Cat. No.
Contractor PRO Lockout/Tagout Kit	44-995

Domestic Installer Lockout/Tagout Kit

- Primarily aimed at the domestic installer
- Contains devices for use on typical breakers found in domestic installations
- Supplied in a handy zipped pouch



Description	Cat. No.
Domestic Installer Lockout/Tagout Kit	44-924

Personal Lockout/Tagout Kit

- A low-cost lockout kit containing two popular lockout devices plus a safety padlock and Do Not Operate tag
- Suitable for individuals or companies wishing to kit out their entire workforce with a low-cost versatile lockout kit



Description	Cat. No.
Personal Lockout/Tagout Kit	44-925

Safety Padlocks

- Dedicated safety lockout device reduces confusion with other locks
- Durable non-conductive, Xenoy lightweight body
- 6 mm triple-coated hardened-steel shackle
- Key retention ensures keys do not get lost while padlock not in use
- Complies with OSHA's "1-key, 1-lock"
- Available in various colours for easy identification



Description	Cat. No.
Safety Padlock 38 mm steel shackle - red	K-8334*
Safety Padlock 38 mm steel shackle - blue	K-8330
Safety Padlock 38 mm steel shackle - yellow	K-8336
Safety Padlock 76 mm long steel shackle - red	K-41021

* Available as blister packaging for retail display - add "-D" to the end of the part number

Non-Conductive Safety Padlocks

- Dedicated safety lockout device reduces confusion with other locks
- Non-conductive, Xenoy lightweight body
- 6 mm non-conductive nylon shackle
- Dielectric protection - anti-sparking
- Key retention ensures keys do not get lost while padlock not in use
- Complies with OSHA's "1-key, 1-lock"
- Available in red or yellow body
- Keyed-alike & Master-Keyed suites available by special order



Description	Cat. No.
Non-Conductive Safety Padlock 38 mm nylon shackle - red	K-40611
Non-Conductive Safety Padlock 38 mm nylon shackle - yellow	K-40612

Universal Hasp (Double Ended)

- Combines small and large hasp
- Allows up to six workers to lock out a single energy source
- Attach hasp to energy disconnect switch
- Control cannot be turned on until last worker's padlock is removed from hasp
- Hasp length 137 mm



Description	Cat. No.
Universal Hasp (Double Ended)	KB-0231

Steel Lockout Hasps

- Steel jaw with vinyl coated handle
- Allows up to six workers to lock out a single energy source
- Attach hasp to energy disconnect switch
- Control cannot be turned on until last worker's padlock is removed from hasp
- 25 mm and 38 mm dia. shackles available



Description	Cat. No.
Steel Lockout Hasp - 38 mm shackle	KB-0224*
Steel Lockout Hasp - 25 mm shackle	IA-5502

* Available as blister packaging for retail display - add "-D" to the end of the part number

Non-Conductive Logout Hasp

- Non-conductive, dielectric protection, anti-sparking
- Allows up to six workers to lock out a single energy source
- Attach hasp to energy disconnect switch
- Control cannot be turned on until last worker's padlock is removed from hasp
- Inside jaw 25 x 63 mm

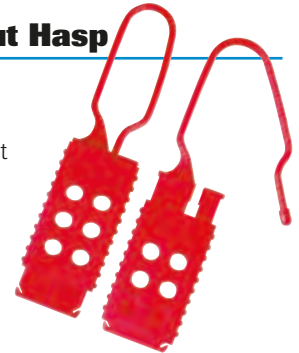

Description	Cat. No.
Non-Conductive Lockout Hasp	44-428EU

Mini-MCB Lockout Device

- Universal device that fits virtually all miniature circuit breakers in the market
- Cover easily pivots open and closed so the dial is inaccessible in the locked position to prevent removal
- Can be applied horizontally or vertically to lock out more than one breaker simultaneously
- Built from a durable, chemical resistant Zenx™ thermoplastic material



Description	Cat. No.
Mini-MCB Lockout Device	KB-1234

Circuit Breaker Lockouts

- Attaches securely to breaker with simple thumb turn and clamping handle
- KB-0226 is designed for breakers with wide or tall toggles
- KB-0227 fits standard height and tie-bar toggles
- The narrow profile permits side-by-side breaker lockout
- Durable construction with powder coated steel and reinforced polymer allows operation in harsh environments



Description	Cat. No.
Circuit Breaker Lockout Kit including one for wide & tall toggles and one for standard single & double toggles	KB-0375*
Circuit Breaker Lockout Kit for wide & tall toggles	KB-0226
Circuit Breaker Lockout Kit for standard single & double toggles	KB-0227

* Available as blister packaging for retail display - add "-D" to the end of the part number

"No-Hole" Lockout Devices

- Lockout device that is ideal for breakers without built-in locking facilities often found in older domestic and commercial installations
- Extremely versatile - works on wide range of single pole and internal-trip multi-pole breakers
- Use thumbscrews to clamp lockout securely onto switch tongue, then pull cover over thumbscrew and lock in place to prevent clamp from being loosened



Description	Cat. No.
"No-Hole" Lockout Device (max. switch 15 mm)	IA-2280
"No-Hole" Lockout Device (max. switch 38 mm)	LA-2182

MCB Lockout Devices

- A safe and effective method for locking out European Circuit Breakers
- The lockout easily installs with the aid of a Push Button
- Recommended to use in combination with a padlock with a shackle diameter up to 6 mm for added safety
- Requires no tools to install



Description	Cat. No.
MCB Lockout Device - Pins Out	441.001*
MCB Lockout Device - Pins In	441.002
MCB Lockout Device - Pins Out Wide	441.003

* Available as blister packaging for retail display - add "-D" to the end of the part number
+44 (0)1925 44 44 46 for Customer Service

Adjustable Cable Lockout

- Adjustable safety hasp and cable
- Ideal for locking out multiple breakers or side-by-side gate valves
- Device can be locked using four padlocks
- Can be adjusted once the cable is locked
- Durable, flexible multi-stranded 1.8 m long vinyl coated steel cable
- Tough, lightweight, dielectric Xenoy thermoplastic body withstands chemicals and performs effectively in extreme conditions



Description	Cat. No.
Adjustable Cable Lockout	44-808

Universal MCB Lockout Devices

- Universal MCB lockout devices useful for isolating MCB's without pin holes on the MCB switches
- Simple and easy to use



Description	Cat. No.
Universal MCB Lockout Device - metal	KB-0234*
Universal MCB Lockout Device - plastic, yellow (small)	44-2393*
Universal MCB Lockout Device - plastic, blue (large)	44-2394

* Available as blister packaging for retail display - add "-D" to the end of the part number

Tie-Bar Lockout Device

- A safe and effective method for locking out non-standard breakers where pins-in / pins-out devices can not be used
- Convenient thumb wheel for quick application
- Recommended to use in combination with a padlock with a shackle diameter up to 6 mm for added safety
- Requires no tools to install

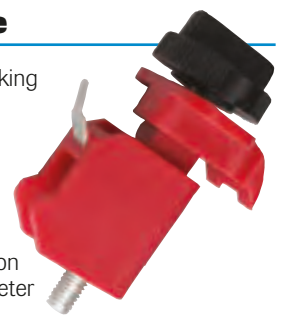

Description	Cat. No.
Tie-Bar Lockout Device	441.004

Lock Stations

- Integrated, one-piece moulded construction
- Resilient polycarbonate material provides heat resistance and high impact strength
- Lockable cover prevents loss of contents
- Secure with a combination lock for simple access control



Description	Cat. No.
5-10 Locks Lockout Station (Station Only)	44-778-S0
10-20 Locks Lockout Station (Station Only)	44-806-S0



Electrical Plug Lockouts

- Surrounds electrical plugs and prevents accidental reconnection
- Designed to enable installation in confined spaces
- Large plug lockout accepts various electrical plugs up to 500V and accommodates wide range of cable diameters
- Small plug lockout is perfect for safe isolation of appliances with a standard mains plug
- Locked out using safety padlock



44-0488



44-0487

Description	Cat. No.
Electrical Plug Cover (Small) 120V - 240V	44-0487
Electrical Plug Cover (Large) 220V - 500V	44-0488

DO NOT OPERATE Lockout Tags

- Heavy duty vinyl tag with metal grommet for extra strength
- Designed to withstand use in harsh environments
- High visibility lettering



Description	Cat. No.
DO NOT OPERATE Lockout Tags - Pack of 5	44-5833EU
DO NOT OPERATE Lockout Tag - 1 piece in blister packaging for retail display	44-833EU

Marking Pen

- Fast-drying, permanent ink will not smear
- For use on lockout tags, write-on marker cards and write-on cable-tie marker plates

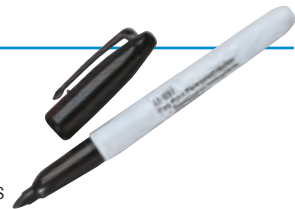

Description	Cat. No.
Marking Pen w/black ink	K-7566

IDEAL Pouch

- Durable zipped pouch
- Keeps your devices safe and helps preventing loss



Description	Cat. No.
IDEAL Pouch	IA-3240

TEST & MEASUREMENT



TightSight® Clamp Meters 1000 & 660 Amp (770 & 760 Series)

- TightSight® bottom display
- Tapered jaws with hook tip
- Measures AC current
- True RMS
- AC/DC Voltage
- Capacitance
- Audible continuity
- Frequency via clamp head or test leads
- Resistance
- High frequency rejection*
- Peak hold
- Max/min hold
- Data hold
- Selectable audible and visual voltage alerts on AC/DC voltage functions
- Selectable auto power off
- Backlit display
- Low battery indicator
- 2-year warranty

*Reads accurately on noisy electrical circuits.



Description	Cat. No.
1000AAC Clamp Meter w/ differentiating features	61-773
1000A AC/DC Clamp Meter	61-775
660AAC Clamp Meter	61-763
660A AC/DC Clamp Meter	61-765

Includes: Carrying Case and Test Leads w/Crocodile Clips.



1000A Clamp (61-773)



660A Clamp (61-763)

Clamp Meters

Specifications	Range & Resolution				Accuracy
	61-773	61-775	61-763	61-765	
AC Current	0.0-999.9A		0.0-660.0A		2.0%
DC Current	—	0.0-999.9A	—	0.0-660.0A	2.0%
AC Voltage	0.0-750.0V				1.0%
DC Voltage	0.0-999.9V				1.0%
Resistance	0.0-999.9Ω				1.5%
Capacitance	0.0-999.9μF				5.0%
Continuity	0.0-999.9Ω				Audible @ <30Ω
Frequency	20.0-400.0Hz				0.5%
Jaw Size	2" (51mm)		1.42" (36mm)		—

Test Leads



Description	Cat. No.
Test Leads with crocodile clips	TL-770

Clamp-Pro™ Clamp Meters 600 Amp (740 Series)

- Measures up to 600AAC
- Non-contact voltage indicator (70V-600VAC)
- Continuity
- Tapered jaws with hook tip
- Auto/manual ranging
- Data hold
- Auto power off
- Low battery indicator
- 2-year warranty

61-744



Compact jaw for use in tight locations.



Description	Cat. No.
600A Clamp Meter w/ TRMS	61-746
600A Clamp Meter	61-744

Includes: Carrying Case and Test Leads.

Specifications Range & Resolution Accuracy

Specifications	Range & Resolution	Accuracy
		61-744 & 61-746
AC Current	40.00/400.0/600A	1.7%
AC Voltage	400.0/600 V	1.2%
DC Voltage	400.0/600 V	0.5%
Resistance	400.0/4.000k/ 40.00k 400.0k/4.000M/40.00M Ω	1.0%

Jaw opening is 1.25" (32mm).

Test-Pro® Multimeters (340 Series)

- Capacitance
- Frequency
- Temperature
- Voltage
- Current
- Resistance
- Audible continuity
- Relative mode
- Backlight
- Min/max
- Data hold
- Low battery indicator
- Auto power off
- 2-year warranty

61-342



Description	Cat. No.
Test-Pro® Multimeter w/TRMS	61-342
Test-Pro® Multimeter	61-340

Includes: Test Leads and Thermocouple.



Replacement Test Leads



Description	Cat. No.
Test Leads with crocodile clips	TL-770

Specifications Range & Resolution Accuracy

Specifications	Range & Resolution	Accuracy
		61-340 & 61-342
AC Voltage	4.000/40.00/400.0/600 V	1.5%
DC Voltage	400.0m/4.000/40.00/400.0/600 V	0.5%
Current	400.0µ/4000µ/40.00m/400.0m/4.000/10.00A AC/DC	1.5%
Resistance	400.0/4.000k/40.00k/400.0k/4.000M/40.00M Ω	1.0%
Capacitance	40.00n/400.0n/4.000µ/ 40.00µ/400.0µ F	3.0%
Frequency	10.000/100.00/1.000k/10.00k/100.0k/1.000M/4.000M Hz	0.3%
Temperature	-4° F to 1382° F (-20° C to 750° C)	3.0%

VoltAware™ Non-Contact Voltage Tester

- Indicates presence of voltage from 40-1000VAC
- Visual indication of voltage
- Selectable audible indication of voltage
- Sleek, compact design
- Green LED indicates power on
- Low battery indicator
- Battery replacement (AAA size)
- 2-year warranty

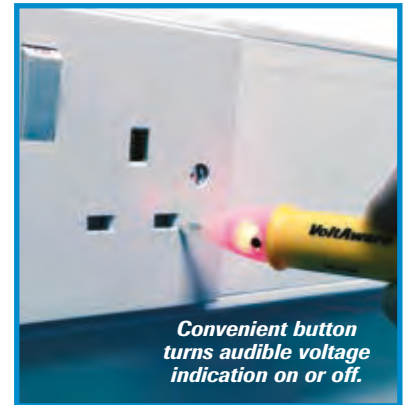
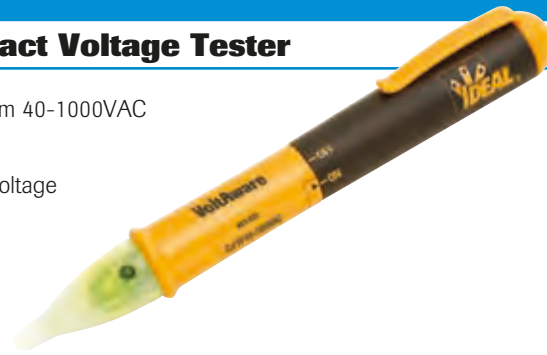

Convenient button turns audible voltage indication on or off.

Description	Cat. No.
VoltAware™ Non-Contact Voltage Tester	61-025EU



Digital Light Meter

- Auto or manual ranging
- Measures in four ranges up to 20,000 FC or 200,000 Lux
- +/- 3% basic accuracy
- Data hold mode
- Max. reading mode
- Auto zero adjustment
- Low battery indication
- Auto power off
- Remote sensor with 59 in. (1.5m) cable



Description	Cat. No.
Digital Light Meter	61-686

Includes: Carrying Case.



Vol-Con® Elite Digital Voltage Tester

- Tests for AC Voltage from 24-600VAC
- Tests for DC Voltage from 6-220VDC
- Visual and audible warning
- Audible continuity
- Non-contact voltage indication (40-600VAC)
- Low impedance to eliminate ghost voltages
- Low battery indicator
- Replaceable GS38 compliant test leads
- Integral lead storage
- 2-year warranty

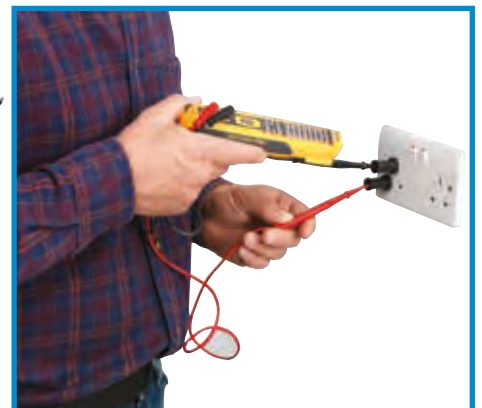

Description	Cat. No.
Vol-Con® Elite Digital Voltage Tester	61-090EU

Accessories

Includes	
GS38 Compliant Test Leads	TL-102EU



SureTrace™ Circuit Tracers

- Receiver display rotates automatically for easy viewing
- Identifies breakers and fuses with CertainCircuit™ detection
- Pinpoints opens and shorts
- Traces wires behind walls
- “0-99” display of signal strength
- Audible intensifies in tone/pitch
- Works on energised or de-energised circuits (0 - 600V AC/DC)
- Four modes of sensitivity – search high, search low, trace and breaker
- Peak detecting bar graph
- 2-year warranty



Scan for product video

61-955



CertainCircuit™

After you identify and trip the correct breaker, the transmitter senses the loss of power and sends a different signal back to the receiver to give you confidence at the panel that the right circuit was de-energised.



Energised



De-energised



The only circuit tracer with SwivelDisplay™

Circuit Tracers

Transmitter will work on a de-energised circuit and won't affect RCD's and sensitive equipment on an energised circuit.



Transmitter and receiver take four standard AA batteries.

NEW
Enhanced
Performance

RC-959 Receiver



RC-955 Receiver



TR-955 Transmitter



Inductive Clamp & Battery Pack



CR-959

Exclusive Rotating Display

Revolutionary technology in the receiver rotates the display in 90° increments so that you always receive an upright reading. Even when the receiver is pointing down, you can keep up.



Circuit Tracers

Description	Cat. No.
Kit Includes: Rotating Display, Inductive Clamp and Battery Pack	61-959
Kit Includes: Rotating Display	61-957
Kit Includes: Standard Display	61-955

Accessories

Includes	
Fuse – High-energy, Fast-acting, 1A/1000V	F-956
Magnetic Strap	61-565
Replacement Lead Set UK (includes 1-6 below)	TL-958UK
Replacement Lead Set EU (includes 1-6 below)	TL-958EU
1. Outlet Plug Adaptor for Transmitter (UK or EU)	
2. Blade Prongs for Lead Adaptors (2/set)	
3. Ground Prong for Lead Adaptor	
4. Crocodile Clips for Lead Adaptors (2/set)	
5. 90 cm (3 ft.) Lead Adaptors for Transmitter (2/set)	
6. 7.5 m (25 ft.) Lead Adaptor for Transmitter	
Optional	
Cradle for Receiver*	CR-959

*Threaded for use on standard extension pole.

Kit Contents	61-955	61-957	61-959
Transmitter	TR-955	TR-955	TR-955
Receiver	RC-955	RC-959	RC-959
Tracer Test Lead Set	TL-956	TL-956	TL-956
Inductive Clamp			IC-958
Battery Pack			BP-958
Hard Carrying Case	C-955	C-957	C-959
Batteries	•	•	•
Instruction Manual	•	•	•

Digital Circuit Breaker Finder & Socket Tester

- Locates breakers and fuses quickly and accurately
- Check polarity and easily identifies common wiring faults
- Verifies presence of power
- Visual and audible indicators
- Non-contact voltage sensor for 80 - 300 VAC
- Optional 61-184EU probe kit for testing at light fixtures
- Comes with soft carrying case
- 2-year warranty



Description	Cat. No.
Digital Circuit Breaker Finder & Socket Tester (includes carrying case)	61-534EU
Crocodile Clip & Probe Set	61-184EU

Specifications

	61-534EU
Operating Voltage	200 - 250 VAC
Operating Frequency	47 - 63 Hz



61-534EU

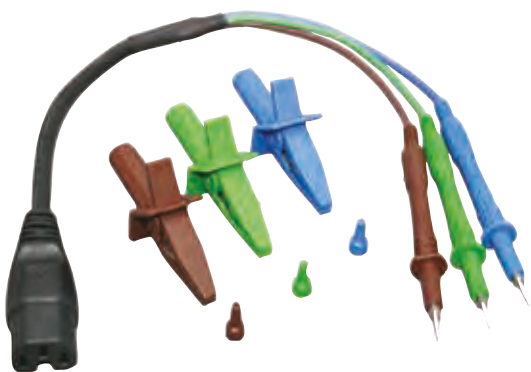

61-184EU

DATAKOM/NETWORKS



LanTEK® III Series Cable Certifier

Superior performance, revolutionary fibre options and outstanding value makes LanTEK® III the ultimate cable certification platform.

The LanTEK III is an easy to use cable certifier that meets existing TIA and ISO/IEC performance requirements for testing up to Cat. 7A/1000MHz.

Using the free IDEAL AnyWARE app, field technicians can share test data with colleagues or customers without leaving the jobsite, resulting in greater collaboration, more on-time job completions and reduced costs

- New troubleshooting features that save time and money – Locate hidden connections, splices and cable faults using Time Domain Return Loss (TDRL) and Time Domain Crosstalk (TDX).
- New permanent link adapter saves money – Reduce down time and lower maintenance costs with field replaceable RJ45 contacts.
- New FiberTEK III modules – Tier 1 certification of fibre cabling eliminates the need for additional fibre testers. Available on 500MHz and 1000MHz models (optional).
- Industry leading battery life – 18 hours of continuous testing without interruption.
- New test data software – Create powerful client reports quickly and easily from multiple testers using one PC application.
- Replaceable Cat 6A permanent link adapter tips – Reduces cost of ownership. Centred connectors provide minimal tolerance and are compatible with all RJ45 twisted pair cabling connectors (optional)



Scan for
more information



FIBERTEK® III

- FiberTEK III adapters are used with LanTEK III for fast and simple certification of high bandwidth single-mode and multimode fibre optic cabling including support for encircled flux testing (optional)
- Certification: Tier 1 certification of single-mode and multimode fibre optic cabling
- Troubleshooting: Red laser light source to visually pinpoint faults and locate fibre ports
- Encircled Flux compliance: Enables compliance to the new fibre standards IEC 14763-3 and ANSI/TIA 526-14-C (optional)
- Field calibration: Allows 1 and 3 jumper field calibration methods to ensure accuracy and compliance to IEC and ANSI/TIA standards
- Simplified bi-directional measurements: Eliminates process of manually merging directional tests into one record



Description	Cat. No.	Description	Cat. No.
LanTEK III-500MHz – (test adapters to be ordered separately)	R161001*	FiberTEK III-MM LED Kit – Includes two multimode FiberTEK III modules	R164005**
LanTEK III-1000MHz – (test adapters to be ordered separately)	R161002*	FiberTEK III-SM Laser Kit – Includes two single-mode FiberTEK III modules	R164006**
LanTEK III-500MHz – (including PL adapters)	R161003**	FiberTEK III-MM LED & SM Laser Kit – Includes two multimode and single-mode FiberTEK III modules	R164007**
LanTEK III-1000MHz – (including PL adapters)	R161004**		
*Contents: LanTEK® III display and remote handset, Li-ion battery (2), universal power adapter (2), USB cable, headset (2), hanging strap (2), quick reference guide, carry case, USB Wi-Fi adapter (1). ** As under * but includes permanent link adapter - R161051 (2).			
**Contents: Lockable semi-rigid carrying case, SC, FC, ST adapters for modules (2 ea.), quick reference guide. (MM kit: SC-SC patch cords 6x 50µm MMF; SM kit: SC-SC patch cords 6x 9µm SMF, MM & SM Kit: SC-SC patch cords 6x 50µm MMF and SC-SC patch cords 6x 9µm SMF) compliant to ISO/IEC 14763-3 standard, quick reference guide, and electronic operation manual.			

SignalTEK™ CT Data Cable Transmission Tester

If you install or maintain data cabling, SignalTEK CT allows you to generate PDF test reports that prove installed links run at Gigabit Ethernet transmission rates.

For installers, this means having a cost-effective way to demonstrate that the copper cabling was installed correctly and is capable of supporting Ethernet applications. By proving real world performance, SignalTEK CT confirms a professional job - reducing the risk of call backs.

SignalTEK CT also gives network owners the assurance that installed cabling will support bandwidth hungry services like VoIP, IP CCTV and video streaming following moves, adds and changes



Testing as simple as 1-2-3



Step 1 Test

- 8 user defined fields available
- Up to 50 individual jobs
- Job information automatically included in the test report documentation
- Enter job site information
- Perform autotest on copper cabling



Step 2 Connect

- Activate SignalTEK CT wireless hotspot
- Connect your mobile phone or tablet with the IDEAL AnyWARE App
- Transfer test reports to your mobile device
- View test reports



Step 3 Send

- Select reports (pdf or csv) to send
- Select preferred transfer method – email, ftp, cloud storage etc.
- Send file
- Alternatively save test reports to USB key

Test Reporting

SignalTEK CT automatically generates test reports in PDF format.

The summary page of each report can be customised to include logo, company and operator details. The summary provides an overview for each link tested including date and time of test, the overall result of the wiremap and data tests, the Ethernet rates that the cable can support, and the individual and total cable lengths.

Detailed information relating to each tested link is reported on subsequent pages. This includes a graphical image of the wiremap, pass/fail information, length per pair, frame errors and data rate.

Scan for
more information



Description	Cat. No.
SignalTEK CT – Data Cable Transmission Tester. Includes 1 x display, 1 x remote, 2 x NiMH batteries, 2 x patch cables - 30cm, Cat 5e STP, 2 x power supply with EU/UK/US adapters, 1 x user manual 1 x carry case	R156004



Test Name	Date (mm/dd/yy)	Time (hh:mm)	Pairs Setup	Wiremap Test	Data Test	10Mb/s	100Mb/s	1Gb/s	Length (m)
0001	03/01/10	00:40	4	✓	✓	✓	✓	✓	17
0002	03/01/10	00:50	4	x	✓	✓	✓	✓	49

0001									
Wiremap Test: ✓									
Pair	1-2	3-6	4-5	7-8					
Length (m)	18	18	18	17					
Data Test: ✓									
Error Limit (Frames)	Duration (hh:mm:ss)	Rate (Mb/s)	Error (Frames)						
0	00:00:10	1000	0						

0002									
Wiremap Test: x									
Pair	1-2	3-6	4-5	7-8					
Length (m)	50	49	49	49					
Data Test: ✓									
Error Limit (Frames)	Duration (hh:mm:ss)	Rate (Mb/s)	Error (Frames)						
0	00:00:10	1000	0						

SignalTEK™ NT Network Transmission Tester

If you install, maintain or troubleshoot data cabling and Ethernet networks, SignalTEK NT allows you to prove the performance up to Gigabit Ethernet transmission rates. By simulating actual network traffic users are able to test and document network and data cable performance to Gigabit Ethernet standards.

Where system warranties are not required the SignalTEK NT is a cost effective way of proving your copper and fibre networks provide error-free performance. SignalTEK NT automatically generates test reports in PDF or CSV format.

Use the free IDEAL AnyWARE™ app from IDEAL Networks to view / send data cable and network test reports to colleagues and clients anywhere.



- Full Gigabit bi-directional load testing through hubs and switches
- Simulate network traffic generated by new IP devices to confirm network capacity before adding new devices like VOIP or CCTV
- Identify Ethernet, Power over Ethernet (PoE) and PoE+ issues, in addition to verifying Ethernet connectivity (including IPv4 and IPv6)
- Locate wiremap faults more quickly and accurately by testing every pin and pair, detecting split pairs and identifying the distance to fault
- Testing complies to the Gigabit Ethernet standard IEEE 802.3ab
- Identify network connection problems as hardware, network or configuration faults
- Ping local network devices and Internet URL's
- Port blink to visually trace cable from work area outlet to network switch
- Field replaceable RJ-45 contacts eliminate downtime from worn or damaged connectors

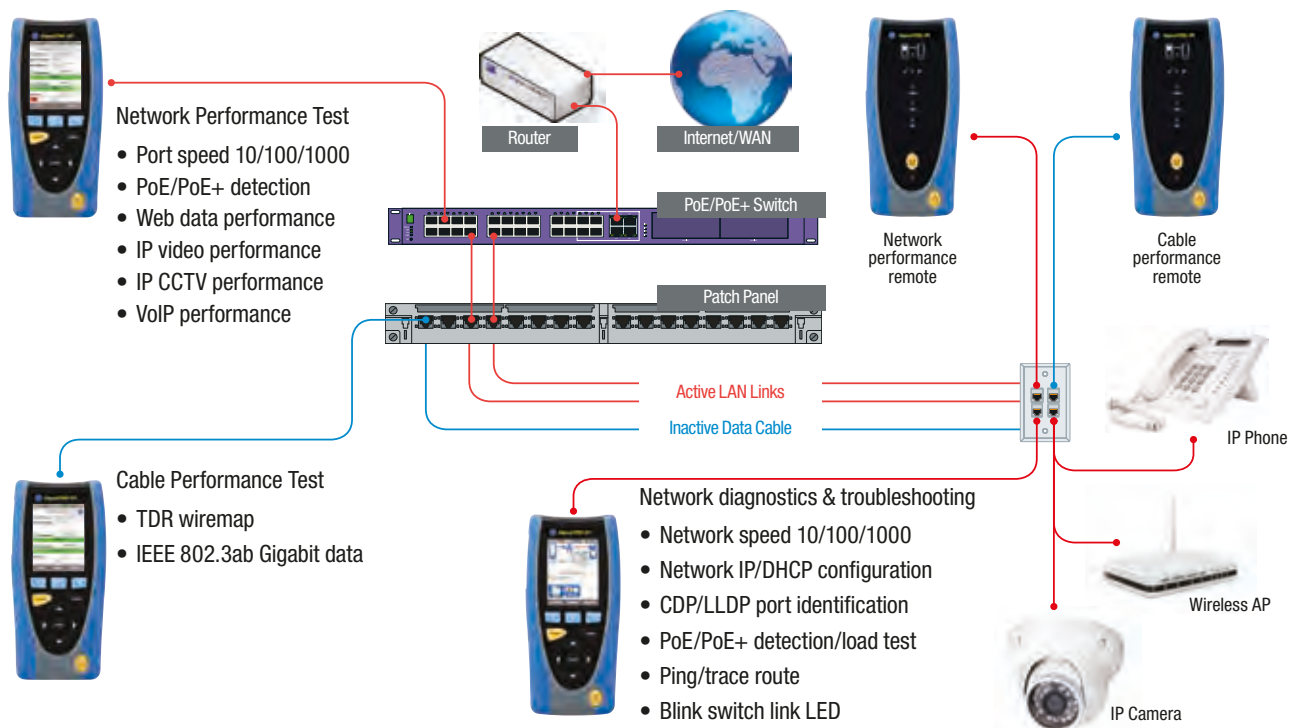

Network Testers

Description	Cat. No.
SignalTEK NT - Network Transmission Tester. Includes 1 x display, 1 x remote, 2 x NiMH batteries, 2 x patch cables - 30cm, Cat 5e STP, 2 x power supply with EU/UK/US adapters, 1 x USB Wi-Fi adapter, 1 x user manual, 1 x carry case	R156003



Scan for more information



NaviTEK NT Network Troubleshooter

The NaviTEK NT is a network tester for troubleshooting and maintenance of active and passive copper and fibre networks. Incorporating an improved graphical interface NaviTEK NT allows network technicians to pinpoint and solve network connectivity issues faster than ever before. Subsequently, tests can be saved as pdf reports and shared with colleagues and clients using the free IDEAL AnyWare™ app.

NaviTEK NT offers a comprehensive suite of test and troubleshooting functionality only found on dedicated hand-held testers:-

- Copper and fibre test interfaces
- Fast detection of link and IP information
- Detects services such as ISDN, POTS and PoE
- Accurate wire mapping including length measurement and distance to fault
- Rugged, compact design permits use in confined spaces
- Not susceptible to virus and malware attack



Port & network summary info



Press the Autotest button to display summary information

VLAN detection & operation

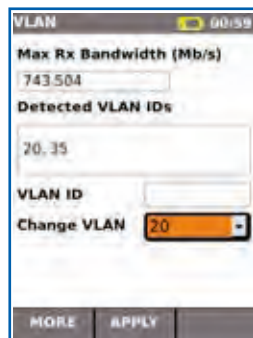

Automatic detection of VLAN ID's

Ethernet utilisation

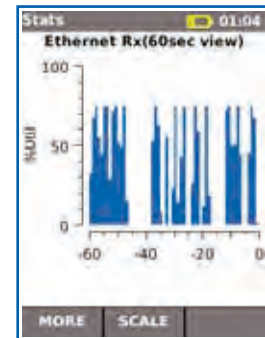

Real time display of broadcast network traffic

CDP/LLDP/EDP port information



Show port information using Discovery Protocols.

Netscan

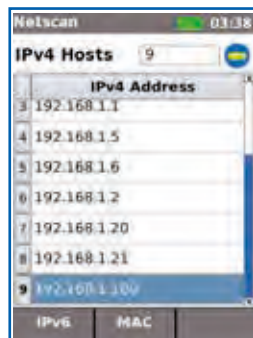

Display list of IP and MAC addresses of every device connected to the network.

Network Probe

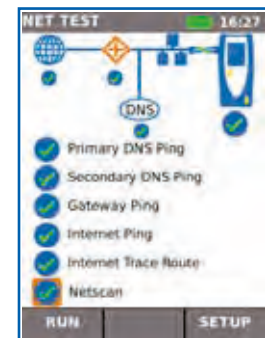

View network illustration to verify test results of each network component.

Description	Cat. No.
NaviTEK NT - 1 x NaviTEK NT test unit, 1 x Remote unit No. 1, 4 x AA dry cell batteries (non-rechargeable), 2 x Patch cables - 30cm, Cat. 5e STP, 1 x Quick reference guide, 1 x Carry case	R153001
NaviTEK NT PLUS - 1 x NaviTEK NT Plus test unit, 1 x Remote unit No. 1, 1 x Rechargeable Power Module, 1 x PSU EU/UK/US adapters, 2 x Patch cables - 30cm, Cat. 5e STP, 1 x USB Wi-Fi adapter, 1 x Quick reference guide, 1 x Carry case	R151003
NaviTEK NT PRO - 1 x NaviTEK NT Pro test unit, 1 x Remote unit No. 1, 1 x Rechargeable Power Module, 1 x PSU EU/UK/US adapters, 2 x Patch cables - 30cm, Cat. 5e STP, 1 x USB Wi-Fi adapter, 1 x Quick reference guide, 1 x Carry case	R151004



Scan for more information



VDV II - Voice, Data and Video Verifier

The new VDV II Series are easy to use cable testers that check the integrity of copper cables commonly found in domestic, commercial or industrial voice, data or video installations, including telephone wiring, data network and video/security cabling.

Employing state-of-the-art technology, VDV II offers functionality not previously available in a wiremapper. The advanced wiremap engine accurately displays complex wiring faults instantaneously whilst TDR (Time Domain Reflectometry) aids troubleshooting and improves on-site productivity.

More than just a wiremapper



VDV II

Performs standard tests for copper cabling, including:

- Coax, 6Pin (RJ11/12), 8Pin (RJ45) Connectors for Copper Cable Testing
- Wiremap for Miswires, Split Pairs, Shorts and Opens
- Analog Tone Generator
- Voltage Protection
- Shielded Cable Testing
- Single Screen Results



VDV II Plus

Additional features to the VDV II:

- Larger 2.9" Display
- Backlight
- Hub Blink
- Cable Length
- Distance to Open
- Carry Case & Cables



VDV II Pro

Additional features to the VDV II Plus:

- Distance to Open / Short (TDR)
- PoE Detection with Voltage Information
- Media Service Detection
- Ethernet Detection with Network Rate and Duplex Information

Applications



VOICE

Support for 1, 2 or 3-pair RJ11/12 telephone cable testing



DATA

Testing of shielded and unshielded Cat 5/5e/6/6A/7 LAN cable

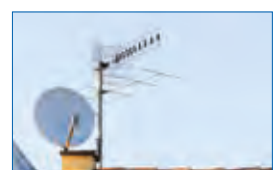

VIDEO

Tests coax cable through F-connector interface

Description	Cat. No.
VDV II – Voice, Data and Video Cable Verifier. Includes 1 x tester, 1 x dual port remote unit, 1 x coax remote unit, 1 x alkaline battery, 1 x multi-language user guide.	R158000
VDV II Plus – Voice, Data and Video Cable Verifier. Includes 1 x tester, 1 x dual port remote unit, 1 x coax remote unit, 1 x alkaline battery, 1 x multi-language user guide, 2 x RJ45 to alligator clip cable 390mm, 2 x screened RJ45 to RJ45 cable 150mm, 2 x RJ11/12 to RJ11/12 cable 100mm, 1 x F-type plug to F-type plug cable 230mm, 1 x F-81 barrel splice, 1 x BNC female to F-type male adapter, 1 x BNC female to F-type female adapter, 1 x RCA female to F-type male adapter, 1 x RCA female to F-type female adapter, 1 x wallet wiring card, 1 x carry case.	R158002
VDV II Pro – Voice, Data and Video Cable Verifier. Includes 1 x tester, 1 x dual port remote unit, 1 x coax remote unit, 1 x alkaline battery, 1 x multi-language user guide, 2 x RJ45 to alligator clip cable 90mm, 2 x screened RJ45 to RJ45 cable 150mm, 2 x RJ12 to RJ12 cable 100mm, 1 x F-type plug to F-type plug cable 230mm, 1 x F-81 barrel splice, 1 x BNC female to F-type male adapter, 1 x BNC female to F-type female adapter, 1 x RCA female to F-type male adapter, 1 x RCA female to F-type female adapter, 1 x wallet wiring card, 1 x carry case.	R158003



For accessories like RJ45 remote units, RJ45 identifiers and Coax remote units, please check out page E-7.

Scan for
more information



FiberMASTER™ Fibre Optic Testers

The IDEAL FiberMASTER™ allows the user to measure absolute power and calculate the insertion loss of fibre optic links at several wavelengths. Measure fibre optic power in microwatts (μW), milliwatts (mW) and decibel-milliwatts (dBm) to test and troubleshoot active Local Area Networks. Plus the 1490nm wavelength measurement mode is perfect for troubleshooting emerging Fibre to the Home cabling systems.

- Tier 1 certification of multi-mode and single mode fibre optic cabling
- **Fibre Optic Power Meter & Light Source** – Four wavelength power meter for multimode and single mode testing, and 850nm multimode LED light source.
- **Calibration Function** – Stores reference power level for quick dB loss measurements eliminating the need to manually calculate loss.
- **Save Time and Money** – Power meter features 2.5mm universal and FC adapters, light source includes ST®, SC and FC adapters to test the most common interfaces.
- **Ready for FTTx** – 1490nm measurement wavelength for use with nearly all single mode Fibre-To-The-Home applications.
- **Designed for the Field** – Unique “docking” light source and easy three-button operation make this the perfect fibre tester for use in the field.

FiberMASTER™ 33-928 Kit Includes:

- 33-926 Light source, 850nm LED with ST®, SC and FC adapters
- 33-927 Power meter, 4 wavelength with universal 2.5mm and fixed FC adapter
- 2x SC-SC 50 μm multimode cables
- 1 SC calibration coupler
- Carrying case
- User manual in English, Spanish, German, French, Portuguese, Italian and Chinese
- 33-931 kit is supplied with quad light source



Description	Cat. No.
Power meter with 850NM fibre light source (33-926 & 33-927)	33-928
Power meter with four wavelength MM/SM light source (33-927 & 33-929)	33-931



Visual Fault Finder

Laser light source used to locate breaks, faulty splices and crimps in fibre optic cabling

- 2.5mm Universal Adapter for all ST®, SC and FC connectors
- Useful over a distance of 5km (3 miles)
- Two AA batteries provide over 30 hours of continuous use
- Slim, pocket-sized tool in rugged solid aluminum body
- Nylon carrying case with belt loop included

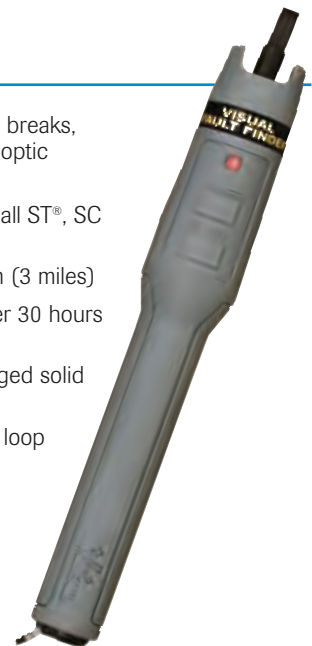

Description	Cat. No.
Visual Fault Finder	VFF5

Note: ST® is a registered trademark of AT&T.

SecuriTEST™ PRO

CCTV installers often need to carry a variety of testing tools to complete their work.

SecuriTEST™ PRO combines the most-needed tools in one easy-to-carry package. Since all connections (video/communications/DMM) attach to a single unit, **SecuriTEST™ PRO** eliminates the need to juggle several devices while on a ladder or lift, making working conditions safer and increasing productivity.

SecuriTEST™ PRO includes IRE testing (video and sync levels), audio level testing, a high-capacity lithiumion battery in a package that's small and light.

The **SecuriTEST™ PRO** has all the features and functionality that CCTV technicians need to install, test and maintain analogue security camera systems. **SecuriTEST™ PRO** also includes a custom carrying case.



Description	Cat. No.
SecuriTEST™ PRO CCTV/Security Tester only	33-892



Tone & Probe Kit



Amplifier Probe

- Identifies and traces wire or cables within a group
- Battery low indicator

Tone Generator

- Emits three different types of tones
- Auto-off after three hours of non-use
- F-Connector port for toning & tracing coaxial CATV cabling systems
- Tone can be added in any status



Description	Cat. No.
Tone Generator	62-160
Amplifier Probe	62-164
Tone & Probe Kit	33-864

Ratchet Telemaster™ RJ-11/RJ-45 Crimp Tool



- Pro quality ratcheting Telemaster™ Tool for RJ-45 and RJ-11 crimping modular plugs
- Gives repeatable crimp action for consistent, high quality connections
- For paired conductors
- Heavy-duty steel frame

Description	Cat. No.
Ratchet Telemaster™ RJ-11/RJ-45 Crimp Tool	30-696
Replacement Cut & Strip Blade Set for 30-696	LA-4102

LinkMaster™ Tester



Tests wiring configurations on UTP/STP cables. Checks for shorts, miswires, reversals and split pairs. Debug feature, automatic shut-off and low battery LED indication.

- Designed to test installed twisted pair wiring
- Tests unshielded and shielded modular plugs
- Main unit and remote allow one person testing

Description	Cat. No.
LinkMaster™ Tester and Remote	62-200



Telemaster™ RJ-11/RJ-45 Crimp Tool



- Multi-function tool cuts, strips and crimps for easy one-tool application
- For paired conductors
- Steel frame for long-term durability. (Crimps primary modular plug strain relief only)

Description	Cat. No.
Tool for RJ-11 (1, 2, 3 pair) and RJ-45 (4 pair) Plugs	30-496-001
Replacement Cut and Strip Blade Set for Telemaster™	LB-1747

*Kit includes 10 each, RJ-45 8P8C, RJ-11 6P6C and RJ-11 6P4C modular plugs.

Crimpmaster™ Crimp Tools & Die Sets

High quality ratchet-type crimp tool for electricians, contractors and installers who require guaranteed repeatability of good mechanical and electrical connections.

Dies change quickly and easily with a screwdriver. Interchangeable dies provide versatility in a single tool

30-506

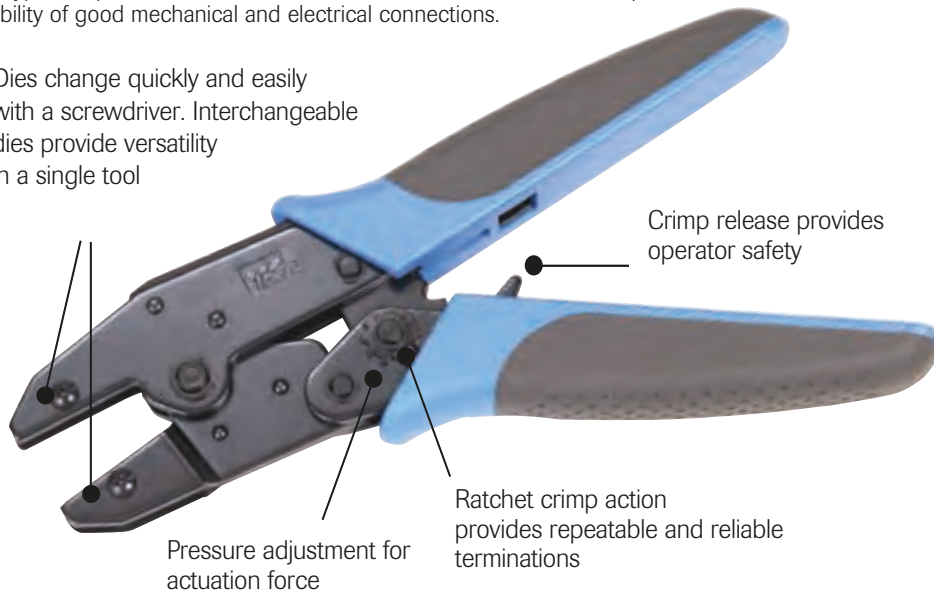

Crimp release provides operator safety

Ratchet crimp action provides repeatable and reliable terminations

Pressure adjustment for actuation force

30-559

RJ-45 Eight-position crimp die set for keyed or non-keyed modular plugs



30-582

Die set for F-type CATV RG-59, RG-6 Connectors (Hex, 0.350 (8.9mm), 0.320 (8.1mm), 0.255 6.5mm)



30-579

Die set for insulated terminals/colour coded nests 22-10 AWG (.3mm² - 5.3mm²)



30-580

Die set for non-insulated terminals 22-8 AWG (0.3mm²-8.0mm²)



30-581

Die set for RG-58, RG-59/62, BNC/TNC Coax Connectors (Hex, 0.255 (6.5mm), 0.213 (5.4mm), 0.068 (1.7mm))



Description	Cat. No.
Crimpmaster™ Crimp Frame Tool	30-506
Die set for RJ-45 eight-position keyed or non-keyed modular plugs	30-559
Die set for insulated terminals/colour coded nests	30-579
Die set for non-insulated terminals	30-580
Die set for RG-58, RG-59/62, BNC/TNC Coax Connectors	30-581
Die set for F-type CATV RG-59, RG-6 Connectors	30-582

PunchMaster™ Punch Down Tool

- Inserts and cuts cable terminations effortlessly
- Professional quality tool
- For seating telecom and data cables into terminals effortlessly
- Adjustable high/low actuation setting accommodates termination requirements
- Turn-Lock™ Style blade holding design
- Impact-absorbing cushioned grip reduces operator stress for high volume installers

35-485

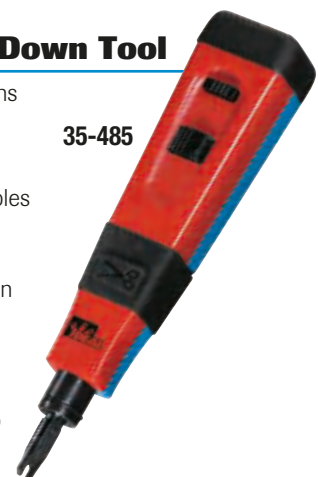

Punch Down Tool

- Insertion tool for Krone blocks
- For seating telecom and data cables into terminals



35-478



Description	Cat. No.
Punch Down Tool (Insertion tool for Krone blocks)	35-482

Description	Cat. No.
Punchmaster™ II Punch Down Tool w/110 & 66 blades	35-485
Removable Krone® Blade for 35-485	35-478

Krone® is a registered trademark of Krone, Inc.

OmniSeal™ PRO Compression Tool

The IDEAL OmniSeal™ PRO Compression Tool offers additional features and increased connector compatibility in a smaller, more compact tool designed to meet the demands of the professional installer.



Most other manufacturers compression connectors can be terminated with an easy plunger depth adjustment. The simple intuitive design combined with its size and universal connector acceptance makes this the only compression tool needed by professional installers.

- Factory preset to work with IDEAL compression connectors
- Compresses F-type, RCA, BNC and Mini connectors
- Adjustable to fit other manufacturer's connectors – no accessory adapters required

Description	Cat. No.
OmniSeal™ PRO XL Compression Tool	30-793



LinearX® Compression Tool Features

- Available in fixed and adjustable versions
- Compresses F/BNC/RCA connectors

A hinged hasp keeps the tool in a compact closed position when not in use

Handle has double dipped textured cushion grip for comfort and all-day use

One handed operation is possible with all compatible connectors.



LinearX3 adjustable post

Durable and rugged zinc die-cast body with a protective powder coated paint finish



Compression Tools

- Available in fixed and adjustable versions
- Compresses F/BNC/RCA connectors
- Durable & rugged zinc die-cast body with protective powder coated paint finish
- Linear stroke for consistent compression results & easy operation
- Includes four RTQ™ RG-6 WeatherProof F-Compression Connectors

LinearX™3 adjustable post



INCLUDES 4 RTQ™ F-Connectors



Description	Cat. No.
LinearX®3 F/BNC/RCA Compression Tool (Adjustable) with four RTQ™ F-Connectors	33-632

Connector & Tool Compatibility Chart

Type	IDEAL Connector	OmniSeal™ Pro XL 30-793	LinearX®3 33-632
F	F 6 RTQ™	✓	✓
	F 6Q RTQ™	✓	✓
	F 6 RTQ™ 90°	✓	✓
	F 59 RTQ™	✓	✓
	F 6 NJX™	✓	✓
	F 6Q NJX™	✓	✓
BNC	BNC 59	✓	✓
	BNC 59 90°	✓	✓
	BNC 6 RTQ™	✓	✓
RCA	RCA 6	✓	✓

✓ No tool adjustment needed. ✓ Tool adjustment needed. — Not compatible.



Hip Kit - 33-622

- Cut, strip and terminate F connectors in one handy starter tool kit

- Kit Includes:

LinearX®1 F-Compression Tool (Fixed)

45-074 Data T®-Cutter

45-605 PrePRO® Cable Stripper

Pouch with clip



Compression Connectors



RTQ™ Reg/Tri/Quad F-Connectors

- Fits 60% regular, tri-shield and quad shield cables
- Nickel-plated, brass-construction for superior corrosion resistance
- Designed for use in satellite and cable TV installations
- WeatherProof™ for indoor and outdoor use
- Use 30-793 or LinearX Compression Tools
- New INSITE™ 90° RG-6 F-Connector version available



INSITE™ BNC Connectors

- Clear 360° window for confident cable insertions
- Nickel-plated, brass-construction for superior corrosion resistance
- Moisture-inhibiting design
- Use 30-793, 30-603 or 33-632 Compression Tool
- 75 Ohm nominal impedance
- Gold-plated pin contact area
- Available in plenum versions



NJX™ F-Connectors

- 75 ohm nominal impedance
- Bandwidth up to 3 GHz
- Compatible with all IDEAL Compression Tools
- Compact body size
- RG-6 and RG-6 Quad versions

Compression Connectors



TLC™ F-Connectors

- No compression tool required
- 75 ohm nominal impedance
- Bandwidth up to 3 GHz
- Compact body size
- RG-6 version

NJX™ F-Compression Connectors

The new NJX™ (pronounced “injects”) compression connector offers a high performing, reliable and economical solution designed for applications that do not require weatherproof connectivity. NJX™ is also great for installers looking to upgrade from traditional hex crimp or twist-on coax F termination methods.

Available in F-Type interfaces for RG-6 and RG-6 Quad cables, the NJX™ connectors are an indoor cable specific alternate to the OmniConn™ series of products. NJX™ connectors require the same 6.5 mm x 6.5 mm (1/4” x 1/4”) cable preparation and compression termination as all other IDEAL compression connectors.

Colour coded, injection moulded bodies make these connectors lighter, more compact, and more cost effective for installers. Unlike traditional compression connectors that get shorter when compressed, the NJX™ series connectors have a post-forward design, which during compression, is “injected” into the body of the connector. Although these connectors are shorter, they still utilise the same compression settings and stroke length as all IDEAL F-compression connectors. Once compressed, the cable is secured creating a permanent 360° compression ring on the cable. NJX™ connectors are designed for applications from 5MHz to 3GHz including CATV and satellite.

For outdoor/weatherproof or universal cable compression products, the RTQ™ series of compression products are recommended.



NJX™ RG-6

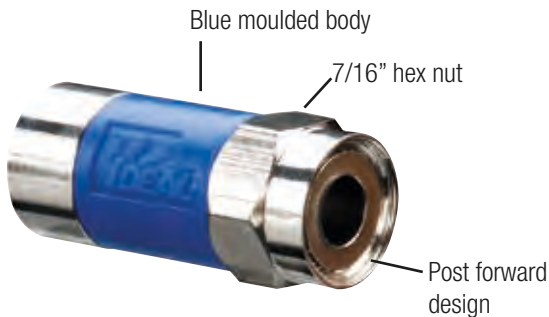

NJX™ RG-6 Quad

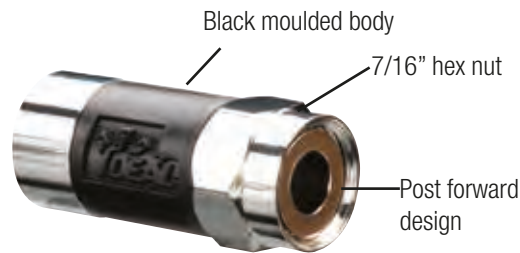

TLC™ Tool-Less Compression Connectors



TLC™ RG-6



The new TLC™ (Tool-Less Compression) RG-6 F compression connector is our simplest, fastest and lowest total cost solution for installing compression connectors. Designed to save the installer **Time, Labour and Cost** when installing indoor RG-6 F-Type connections **no compression tool is required** to terminate these connectors.

The TLC™ connector is an indoor, cable specific alternate to the NJX™ series of products.

The TLC™ connector uses the standard 6.5 mm x 6.5 mm (1/4” x 1/4”) cable preparation, that does not require a compression tool to complete the termination process. TLC™ series connectors feature a sliding post design to capture and secure the cable inside of the connector. After the cable is inserted, tightening the connector to the device completes assembly process, creating a 360° compression point and a permanent connection.

IDEAL F/BNC insertion tools (35-046, 35-042, 35-043) can be used (but are not required) when installing the TLC™ cable assembly to ensure connectors are properly torqued and fully seated to the female barrel. These connectors are designed for applications from 5MHz to 3GHz including CATV and satellite.

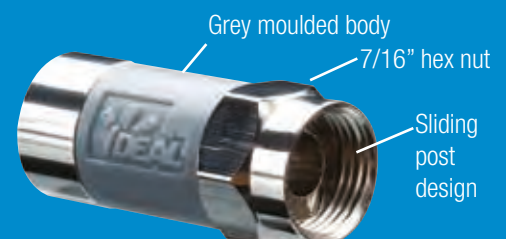

Compression Connectors

Model	Type	Model	Cable Type	Qty.	Cat. No.
	F	RTQ™	RG-59 / Reg/Tri/Quad	Card of 10 Jar of 50	92-611 92-610
	F	RTQ™	PF100/CT100/RG-6/ Reg/Tri/Quad	Card of 10 Jar of 50	92-651 92-650
	F	TLC™	RG-6	Card of 10 Card of 50	85-068 85-168
	F	NJX™	RG-6	Card of 10	89-040
	F	NJX™	RG-6 Quad	Card of 10	89-041
	F	InSITE™ RTQ™ 90°	RG-6	Card of 5	92-691
	BNC	InSITE™ 90°	RG-59	Card of 5	92-693
	BNC	InSITE™ RTQ™	RG-6	Card of 15	89-048
	BNC	InSITE™	RG-59	Card of 15	89-047

1GHz Cable Splitters

- Nickel-plated housing, soldered back
- High-performance impedance - balanced Printed Circuit Board design
- Bandwidth: 5MHz - 1 GHz Impedance: 75 Ω; Splits signals up to 8 outlets



Description	Cat. No.
High Performance Cable Splitter, 5MHz-1GHz, 2-Way	85-132
High Performance Cable Splitter, 5MHz-1GHz, 4-Way	85-134

All IDEAL compression connectors require a standard 6.5 mm x 6.5 mm (1/4" X 1/4") cable preparation. This preparation leaves 6.5 mm (1/4") of the centre conductor exposed and an additional 6.5 mm (1/4") of the shielding exposed. Prep tools are available in single, two or three blade models. Two blade models are the most commonly used type of stripping tool for coax compression as they remove both 6.5 mm (1/4") sections at one time during the prep. Single blade models require two separate stripping actions for compression preparation. IDEAL has several models of cable preparation tools that are compatible with compression connectors, each having various feature choices such as user adjustable blade depths, replaceable blades, number of active blades, product size and hand motion required to prep the cable.

Compression Cable Prep Instructions



Start with a clean piece/fresh cut of coax.



Prep/strip cable to size.



Fold back braiding. Leave inner foil intact.

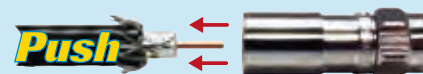

Check for flush dielectric and no visible wrapped braiding strands.



Fully compress the connector with appropriate tool.



Connect to device. Use the F/BNC insertion tool if needed to reach proper tightening torque.

FT-45™ Modular Plug Crimp Tool



The FT-45™ is a simple, compact and highly effective crimp tool for installers and technicians that terminate RJ45 connectors regularly.

- Quality - Cleanly shears the excess conductors and leaves a smooth, flat finish
- Versatile - Suitable with Feed-Thru, standard, or shielded connectors (CAT5e or CAT6)
- Heavy duty - Cutting blade that will last for over 2,000 cuts
- Ergonomic - Reduced hand force compared to traditional crimp tools
- Compact - Easily fits in your pocket and lightens the tool bag load
- Easy to use - 568A & 568B wiring scheme marked on the tool
- Easily maintained - Replaceable cutting blades available
- Patented design - Patent pending design requires less than 1/2 of the mechanical force to crimp connectors. No ratchet needed.
- A patent pending design enables conductors to be cut flush with the end face of the connector when used with the FT-45™ tool

Description	Cat. No.
FT-45™ Feed-Thru Modular Plug Crimp Tool	30-495
FT-45™ Replacement Blade	30-4951

CAT5e/6 Feed-Thru RJ-45 Modular Plugs

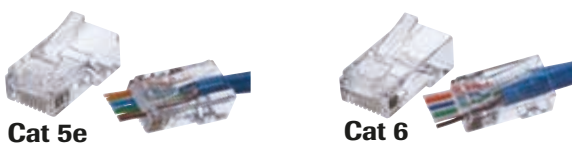

Open-end Feed-Thru connectors offer several advantages over standard closed end connectors.

- Reduces errors - Wires can be easily verified before trimming.
- Easy to use - Conductors do not need to be pre-trimmed to a specific length
- Improved wire stability - 3 prong contacts into every wire for more conductive contact points

Description	Qty.	Cat. No.
CAT5e Feed-Thru RJ-45 Modular Plugs	25	85-370
CAT5e Feed-Thru RJ-45 Modular Plugs	50	85-371
CAT5e Feed-Thru RJ-45 Modular Plugs	100	85-372
CAT6 Feed-Thru RJ-45 Modular Plugs	25	85-375
CAT6 Feed-Thru RJ-45 Modular Plugs	50	85-376
CAT6 Feed-Thru RJ-45 Modular Plugs	100	85-377

Modular Plugs

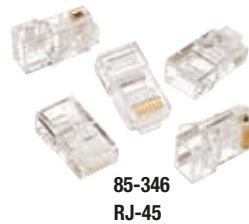

**85-346
RJ-45**



**85-344
RJ-11**

- Plugs are capable of supporting the latest EIA/TIA cable system performance categories when installed in compliance with appropriate EIA/TIA standards and methods
- All plugs work with 24 AWG solid or stranded conductors and round or flat cables.

Description	Qty.	Cat. No.
8-Position 8-Contact, RJ-45	25	85-346
6-Position 6-Contact, RJ-11	25	85-345
6-Position 4-Contact, RJ-11	25	85-344

CAT 6 RJ-45 Modular Plugs



- Unique three-piece design provides easy installation and optimal performance
- Crimps with a standard RJ-45 crimp die
- 50 micron gold contacts, 8-position, 8-contact
- Suitable for solid or stranded conductors - 22 - 23 AWG

Description	Qty.	Cat. No.
CAT 6 RJ-45 Modular Plugs	25	85-366

Strain Relief Boots for Modular Plugs

- Prevents broken connector tabs and snagging while extending connector life
- Minimises cable bends that can reduce data speed and result in data loss
- Dampens cable movement and vibrations that can result in premature connector failure



Description	Qty.	Cat. No.
Strain Relief Boots for Modular Plugs	25	85-380

UTP/STP/Coaxial Cable Strippers

- Adjustable blades can be set for any depth to help ensure nick-free stripping and slitting of cables

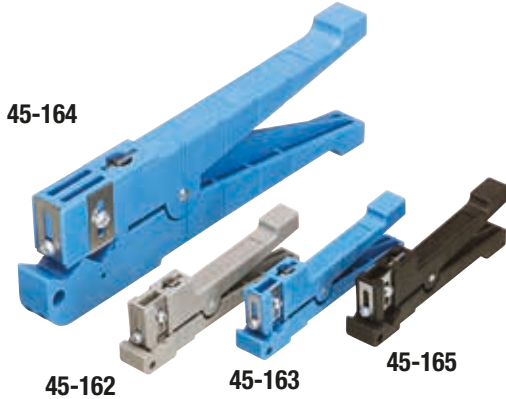

Description	Typical RG Cables	Cat. No.
Coaxial Cable Stripper, up to 1/8 in. (3.2mm) O.D	RG-174, RG-187	45-162 (Grey)
Coaxial Cable Stripper, 1/8 in. (3.2mm) to 7/32 in. (5.56mm) O.D.	Mini Coax RG-58,CB	45-163 (Blue)
Coaxial Cable Stripper, 1/4 in. (6.4mm) to 9/16 in. (14.3mm) O.D.	RG-11, RG-8	45-164 (Blue)
Cable Stripper, 3/16 in. (4.8mm) to 5/16 in. (8mm) O.D.	RG-59/6, UTP Cable	45-165 (Black)
Replacement Blade Set* for 45-162, 45-163, 45-165	—	L-9225
Replacement Blade Set* for 45-164	—	L-9226

*A set of blades consists of three straight blades and one round blade.

Coax Stripper

- Specific adjustments needed for each cable size
- For crimp BNC and TNC connectors
- Strips braid 0.240 in. or 6mm and dielectric 0.240 in. or 6mm



Description	Cat. No.
Coax Stripper - 3 Step <ul style="list-style-type: none"> For crimp BNC and TNC connectors Strips braid 0.240 in. or 6mm and dielectric 0.240 in. or 6mm 	45-520

Kinetic Super™ Wire Stripper/Crimper



- Cuts and strips 22 to 24 AWG
- Crimps IDC Connectors

Description	Cat. No.
Kinetic Super™ Wire Stripper/Crimper Kit – includes 25 IDC's (UR-1, 3-Wire Butt Splice)	33-719

Insulation Displacement Connectors (IDC)



85-900

85-925

85-950

IDC connectors create fast splice and tap connections on solid copper wires. Designed for low voltage telecommunication cables.

- Moisture-resistant sealant protects wires from corrosion
- Use with solid copper single-conductor wire
- Kinetic Super™ Wire Stripper/Crimper easily cuts and strips 22 to 24 AWG solid wire

Description	Qty.	Cat. No.
UR-1, 3-Wire Butt Splice IDC	25	85-925
UR-1, 3-Wire Butt Splice IDC	100	86-925
IDC Combo Pack	25	85-960
UY-1, 2-Wire Butt Splice IDC	25	85-950
UB-1, 2-Wire Tap Splice IDC	25	85-900

PrepPRO™ Coax/UTP Cable Stripper

- Auto adjusting blade depth for 6/6Quad/59 coax cable
- 1/4" x 1/4" coax preparation
- Replaceable blade cartridges
- CAT5e/6 jacket stripping
- Spring loaded for consistent cutting force



Description	Cat. No.
PrepPRO™ Coax/UTP Cable Stripper	45-605

Data T[®]-Cutter



- Cuts round communication cable and maintains cable geometry for better cable performance
- Cuts multi-pair cable up to .500 in. (12.7mm) and coaxial cable up to RG-9/U
- Suitable for soft cables (not steel reinforced)
- Steel reinforced centre conductors can be trimmed with bolt cutting holes
- Locking latch keeps tool closed in pouch

Description	Cat. No.
Data T [®] -Cutter	45-074

Good Round dielectric

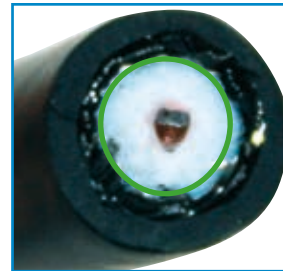

Bad Oval dielectric



Network Tester Accessories

Description	Cat. No.
SignalTEK NT / NaviTEK NT remote kit #2-#12	150050
SignalTEK NT / NaviTEK NT remote #1	150054
SignalTEK NT / NaviTEK NT Cat 5e STP patch cables (2)	150055
SignalTEK NT / NaviTEK NT duplex multi-mode patch cable	150056
SignalTEK NT / NaviTEK NT duplex single mode patch cable	150057
SignalTEK NT / NaviTEK NT RJ-45 insertion/removal tool and 10 RJ-45 inserts	150058
SignalTEK NT / NaviTEK NT active remote kit #2 - #6	150059
SignalTEK NT / NaviTEK NT power supply with EU/UK/US adapters	151051
SignalTEK NT / NaviTEK NT alkaline battery module	151052
SignalTEK NT NIMH power module	151053
NaviTEK NT carrying case	151054
SignalTEK NT carrying case	156050
VDV II RJ-45 remote kit #1 - #12	158050
VDV II RJ-45 identifier kit #1 - #24	158051
VDV II coax remote kit #1 - #12	158053
SignalTEK NT / NaviTEK NT 1310nm single mode SFP module	MGK LX2
SignalTEK NT / NaviTEK NT 850nm multi-mode SFP module	MGK SX1
SignalTEK NT / NaviTEK NT 1550nm single mode SFP module	MGK ZX3

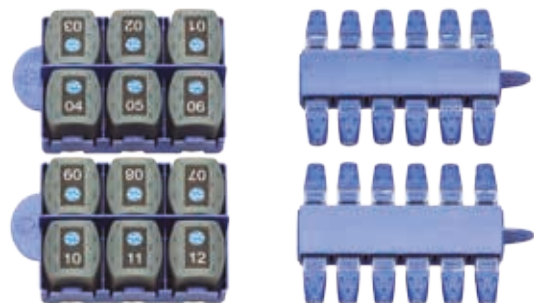

158050

158051



150050

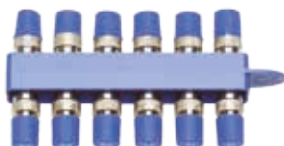

158053

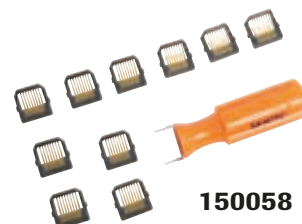

150058

Item	Page
1GHz Cable splitters.....	E-14
7-in1 Stripper	B-7
A	
Accessories for networks testers.....	E-17
Adjustable Cable Lockout..	C-5
Amplifier Probe.....	E-9
Anti-Oxidant, Noalox®.....	B-5
Aqua-Gel® II Cable Pulling Lubricant	B-4
Auto-Lock™ Tape	
Measure.....	B-14
B	
Bag, Large Mouth	B-14
BenderBoot™	B-6
Benders, Conduit	B-6
Blued-Steel™ Fish	
Tapes	B-2, B-3
C	
Cable Certifier,	
LanTEK® III.....	E-2
Cable Cutter PowerBlade™	B-10
Cable Cutter, Ratcheting	B-11
Cable Cutters	B-9
Cable Lockout, Adjustable..	C-5
Cable Splitters.....	E-14
Cable Stripper, Twin & Earth	B-8
CAT 5e/6 Feed-Thru RJ-45 Modular Plugs.....	E-15
CAT 6 RJ-45 Modular Plugs.....	E-15
CCTV/Satellite Coax Stripper.....	E-16
CCTV/Security Tester, SecuriTEST PRO.....	E-7
Certifier, Cable, LanTEK® III	E-2
Circuit Breaker Finder.....	D-8
Circuit Breaker Lockouts...	C-5
Circuit Tracers, SureTrace™	D-6, D-7
Clamp Meter Selection Guide	D-2
Clamp Meters, Clamp-Pro™	D-4
Clamp Meters, TightSight®	D-3
Clamp-Pro™ Clamp Meters	D-4
ClearGlide™ Wire Pulling Lubricant	B-4
Coax Cable F-Terminators	E-13
Coax Strippers.....	E-16
Compression	
Connectors	E12-E14
Compression Tools.....	E-11
Conduit Benders.....	B-6
Connectors, Insulation	

Item	Page
Displacement	E-16
Contractor Lockout/ Tagout Kit	C-2, C-3
Contractor Pro Lockout/ Tagout Kit	C-2, C-3
Crimp Tool, Crimpmaster™	E-10
Crimp Tool, FT-45™ Modular Plug.....	E-15
Crimp Tool, Ratchet.....	B-14
Crimper/Stripper, Kinetic Super™	E-16
Crimpmaster™ Crimp Tool	E-10
Cutter, Cable Ratcheting	B-11
Cutter, Data	B-9, E-16
Cutter, Long-Arm	B-9
Cutter, PowerBlade™	B-10
D	
Data & Video, Voice Verifier	E-6
Data Cable Transmission Tester, SignalTEK CT	E-3
Data T®-Cutter	B-9, E-17
Digital Circuit Breaker Finder	D-8
Digital Light Meter.....	D-5
Digital Voltage Tester, Vol-Con® Elite	D-5
Displacement Connectors, Insulation	E-16
Domestic Installer Lockout/ Tagout Kit	C-2, C-3
Duct Seal.....	B-5
E	
Electrical Plug Lockouts ...	C-6
F	
Feed-Thru RJ-45 Modular Plugs, Cat 5e/6	E-15
FiberMASTER™ Fibre Optic Testers	E-7
FIBERTEK III Modules	E-2
Fibre Optic Testers.....	E-7
Fish-Tapes.....	B-2, B-3
FT-45™ Modular Plug Crimp Tool.....	E-15
F-Terminators, Coax Cable	E-13
Fuse Puller, Safe-T-Grip®	B-14
H	
Hacksaw, Heavy-Duty	B-14
Handles for Benders	B-6
Hasp, Universal.....	C-4
I	
In-Line Wire Connectors,	

Item	Page
SpliceLine®	A-4
InSITE™ Compression	
Connectors	E12-E14
Installer, Domestic, Lockout/ Tagout Kit	C-2, C-3
Insulated T®-Stripper Wire Stripper, Premium.....	B-8
Insulation Displacement Connectors	E-16
In-Sure® Lever Wire Connectors	A-3
In-Sure® Push-In Wire Connectors	A-2
K	
Kinetic Super™ Wire Stripper/Crimper.....	E-16
L	
LanTEK® III Series Cable Certifier.....	E-2
Leads, Test.....	D-3, D4
Lever Wire Connectors, In-Sure™	A-3
Light Meter, Digital	D-5
Lil' Ripper Stripper	B-7
LinearX® Hip Kit	E-11
LinearX® Compression Tool.....	E-11
LinkMaster™ Tester	E-9
Lock Stations.....	C-6
Lockout Device, Tie-Bar ...	C-5
Lockout Devices, MCB ...	C-5
Lockout Devices, Universal MCB	C-5
Lockout Hasps, Steel, ...	C-4
Lockout Tags.....	C-6
Lockout/Tagout Kits... C-2, C-3	
Lockouts, Circuit Breaker ..	C-5
Lockouts, Electrical Plug... C-6	
Logout Hasp, Non-Conductive	C-4
Long-Arm Cable Cutter....	B-9
Lubricants, Wire Pulling ...	B-4
M	
Marking Pen	C-6
MCB Lockout Devices.....	C-5
Mini-MCB Lockout Device..	C-4
Modular Plug Crimp Tool, FT-45™	E-15
Modular Plugs.....	E-15
Modules, Fibre	E-2
Multimeter Selection Guide	D-2
Multimeters, Test-Pro®....	D-4

Item	Page
N	
NaviteK NT Network Troubleshooter	E-5
Network tester accessories	E-17
Network Transmission Tester, SignalTEK NT.....	E-4
Network Troubleshooter, NaviTEK NT.....	E-5
NJX™ Compression Connectors	E-12-E14
Noalox® Anti-Oxidant.....	B-5
No-Hole Lockout Devices..	C-5
Non-Conductive Logout Hasp	C-4
Non-Conductive Safety Padlocks.....	C-4
Non-Contact Voltage Tester, VoltAware™	D-5
O	
OmniSeal™ PRO Compression Tools.....	E-11
Optical, Fibre Testers.....	E-7
P	
Padlocks, Safety	C-4
Pen, Marking.....	C-6
Personal Lockout/ Tagout Kit	C-2, C-3
Plug Lockouts, Electrical... C-6	
Plugs, RJ-45 Modular, Cat 5e/6 Feed-Thru	E-15
Pouch	C-6
PowerBlade™ Cable Cutter	B-10
Premium Insulated T®-Stripper Wire Stripper.....	B-8
PrepPRO™ Coax/UTP Cable Stripper.....	E-16
Puller, Fuse, Safe-T-Grip®	B-14
Punch Down Tools.....	E-10
Push-In Wire Connectors, In-Sure™	A-2
Q	
Quick Change Screwdriver	B-13
R	
Ratchet Crimp Tool	B-14
Ratchet Telemaster™	E-9
Ratcheting Cable Cutter	B-11
Reflex™ Premium T®-Stripper Wire Strippers.....	B-7
RTQ™ Compression Connectors	E12-E14

<u>Item</u>	<u>Page</u>	<u>Item</u>	<u>Page</u>
S			
Safe-T-Grip®		Tools, Punch Down	E-10
Fuse Puller	B-14	Transmission Tester,	
Safety Padlocks	C-4	Data Cable, SignalTEK CT . . .	E-3
Satellite/CCTV		Transmission Tester,	
Coax Stripper	E-16	Network, SignalTEK NT	E-4
Screwdriver, Quick		Twin & Earth Cable Stripper	B-8
Change	B-13	Twister® Wire Connectors .	A-5
SecuriTEST PRO		U	
CCTV/Security Tester	E-8	Universal Hasp	C-4
Selection Guide,		Universal MCB Lockout	
Clamp Meter	D-2	Devices	C-5
Selection Guide, Multimeter	D-2	UPT/STP/Coaxial Cable	
SignalTEK CT Data Cable		Strippers	E-16
Transmission Tester	E-3	V	
SignalTEK NT Network		VDV II, Voice, Data &	
Transmission Tester	E-4	Video Verifier	E-6
Socket Tester	D-8	Video, Voice & Data Verifier	E-6
SpliceLine® In-Line Wire		Visual Fault Finder	E-7
Connectors	A-4	Voice, Data & Video Verifier	E-6
Splitters, Cable	E-14	Vol-Con® Elite Digital	
Stations, Lock	C-6	Voltage Tester	D-5
Steel Lockout Hasps	C-4	Voltage Tester, Digital	D-5
STP/UTP Coaxial Cable		Voltage Tester, Non-Contact	D-5
Strippers	E-16	VoltAware™ Non-Contact	
Strain Relief Boots	E-15	Voltage Tester	D-5
Stripmaster® Wire Stripper	B-8	Volt-Guard Fish Tapes .	B-2, B-3
Strippers, Coax	E-16	W	
Strippers, T®-Stripper Wire	B-7	WeatherProof Wire	
SureTrace™ Circuit		Connectors	A-5
Tracers	D-6, D-7	Wire Connector Kits	A-6
T			
T®-Cutter Data	B-9, E-16	Wire Connectors,	
T®-Stripper Wire Strippers.	B-7	In-Sure™ Lever	A-3
Tagout, Lockout Kits . .	C-2, C-3	Wire Connectors, In-Sure™	
Tags, Lockout	C-6	Push-In	A-2
Tape Measure,		Wire Connectors,	
Auto-Lock™	B-14	SpliceLine® In-Line	A-4
Telemaster™ RJ11/RJ-45		Wire Connectors, Twister®.	A-5
Crimp Tool	E-10	Wire Connectors,	
Telemaster™, Ratchet	E-9	WeatherProof®	A-5
Test Leads	D-3	Wire Crimper/Stripper,	
Tester, LinkMaster™	E-9	Kinetic Super™	E-16
Tester, Socket	D-8	Wire Cutter, T®-Cutter	B-9
Testers, Data Cable		Wire Pulling Lubricants	B-4
Transmission, SignalTEK CT	E-3	Wire Stripper, Stripmaster®	B-8
Testers, Network		Wire Stripper/Crimper,	
Transmission, SignalTEK NT	E-4	Kinetic Super™	E-16
Test-Pro® Multimeters	D-4	Y	
Tie-Bar Lockout Device	C-5	Yellow 77® Wire Pulling	
TightSight® Clamp Meters.	D-3	Lubricant	B-4
TLC™ Compression		Z	
Connectors	E12-E14	Zoom™ Fish Tapes	B-2, B-3
Tone & Probe Kit	E-9		
Tone Generator	E-9		

Item	Page	Item	Page	Item	Page	Item	Page	
441.001	C-5	30-506	E-10	44-2393	C-5	74-		
441.002	C-5	30-559	E-10	44-2394	C-5		74-002	B-6
441.003	C-5	30-579	E-10	44-428EU	C-4		74-003	B-6
441.004	C-5	30-580	E-10	44-5833EU	C-6		74-019	B-6
15...		30-581	E-10	44-778-SO	C-6	74-020	B-6	
150050	E-17	30-582	E-10	44-806-SO	C-6	74-027	B-6	
150054	E-17	30-696	E-9	44-808	C-5	74-028	B-6	
150055	E-17	30-793	E-11	44-833EU	C-2			
150056	E-17	31-		44-924	C-3	83-		
150057	E-17	31-055	B-3	44-925	C-3		83-001	B-14
150058	E-17	31-056	B-3	44-985UK	C-3	85-		
150059	E-17	31-057	B-3	44-995	C-3		85-068	E-14
151051	E-17	31-090	B-3	45-		85-132	E-14	
151052	E-17	31-092	B-3	45-025	B-7	85-134	E-14	
151053	E-17	31-351	B-4	45-074	B-9, E-17	85-168	E-14	
151054	E-17	31-355	B-4	45-120-341	B-7	85-344	E-15	
156050	E-17	31-358	B-4	45-123	B-9	85-345	E-15	
158050	E-17	31-378	B-4	45-125-341	B-7	85-346	E-15	
158051	E-17	31-388	B-4	45-162	E-16	85-366	E-15	
158053	E-17	31-542	B-3	45-163	E-16	85-370	E-15	
30-		31-544	B-3	45-164	E-16	85-371	E-15	
30-024	B-5	31-601	B-5	45-165	E-16	85-372	E-15	
30-026	B-5	31-605	B-5	45-235	B-8	85-375	E-15	
30-087	A-2	33-		45-292-341	B-8	85-376	E-15	
30-088	A-2	33-622	E-11	45-425-341	B-7	85-377	E-15	
30-090	A-2	33-632	E-11	45-520	E-16	85-380	E-15	
30-1032	A-2	33-719	E-16	E-16		85-900	E-16	
30-1033	A-2	33-864	E-9	45-777	B-7	85-925	E-16	
30-1034	A-2	33-892	E-7	45-9120-341	B-8	85-950	E-16	
30-1042	A-4	33-928	E-7	61-		85-960	E-16	
30-1052	A-3	33-931	E-7	61-025EU	D-5	86-		
30-1053	A-3	34-		61-090EU	D-5		86-925	E-16
30-1055	A-3	34-002	B-14	61-184EU	D-8	89-		
30-1059	A-3	35-		61-340	D-4		89-040	E-14
30-1161	A-5	35-033	B-9	61-342	D-4	89-041	E-14	
30-1162	A-5	35-053	B-12	61-534EU	D-8	89-047	E-14	
30-1163	A-5	35-078	B-10	61-686	D-5	89-048	E-14	
30-1342S	A-4	35-242M	B-14	61-744	D-4			
30-144	A-5	35-260	B-14	61-746	D-4	92-		
30-340	A-5	35-410	B-14	61-763	D-3		92-610	E-14
30-341	A-5	35-478	E-10	61-765	D-3	92-611	E-14	
30-342	A-5	35-482	E-10	61-773	D-3	92-650	E-14	
30-495	E-15	35-485	E-10	61-775	D-3	92-651	E-14	
30-4951	E-15	35-933	B-13	61-955	D-6, D-7	92-691	E-14	
30-496-001	E-9	35-934	B-13	61-957	D-6, D-7	92-693	E-14	
30-5000EU	A-6	44-		61-959	D-6, D-7			
30-5001EU	A-6	44-0487	C-6	62-		B		
30-5005EU	A-6	44-0488	C-6	62-160	E-9		BP-958	D-7
30-5006EU	A-6			62-164	E-9			
30-5011EU	A-6			62-200	E-9			
30-5020EU	A-6							
30-5021EU	A-6							

<u>Item</u>	<u>Page</u>	<u>Item</u>	<u>Page</u>
C		R164005.....	E-2
CR-959.....	D-7	R164006.....	E-2
H		R164007.....	E-2
H-4076.....	B-6	RC-955.....	D-7
I		RC-959.....	D-7
IA-2280.....	C-5	T	
IA-3240.....	C-6	TL-100.....	D-4
IA-5502.....	C-4	TL-102EU.....	D-5
IC-958.....	D-7	TL-104.....	D-3
K		TL-956.....	D-7
K-40611.....	C-4	TR-955.....	D-7
K-40612.....	C-4	V	
K-41021.....	C-4	VFF5.....	E-7
K-7566.....	C-6		
K-8330.....	C-4		
K-8334.....	C-4		
K-8336.....	C-4		
KB-0224.....	C-4		
KB-0226.....	C-5		
KB-0227.....	C-5		
KB-0231.....	C-4		
KB-0234.....	C-5		
KB-0375.....	C-5		
KB-1234.....	C-4		
L			
L-9225.....	E-16		
L-9226.....	E-16		
LA-2182.....	C-5		
LA-4102.....	E-9		
LB-1747.....	E-9		
M			
MGKLX2.....	E-17		
MGKSX1.....	E-17		
MGKZX3.....	E-17		
R			
R151003.....	E-5		
R151004.....	E-5		
R153001.....	E-5		
R156003.....	E-4		
R156004.....	E-3		
R158000.....	E-6		
R158002.....	E-6		
R158003.....	E-6		
R161001.....	E-2		
R161002.....	E-2		
R161003.....	E-2		
R161004.....	E-2		

Merchandising

Point-of-purchase communication is an important aspect of IDEAL sales strategy. We are committed to helping our distributors move our products off their shelves. To do that, we've developed a variety of exciting, useful ways to increase a store's association with IDEAL and to build repeat customers.



Counter Top Displays



WIRE CONNECTOR DISPLAYS

IDEAL offers a range of merchandising solutions to display pre-defined or custom profiles of push-in, lever wire, SpliceLine and twist-on wire connectors. Options include floor standing and more compact counter/shelf display units, each designed to create high impact and drive impulse sales.

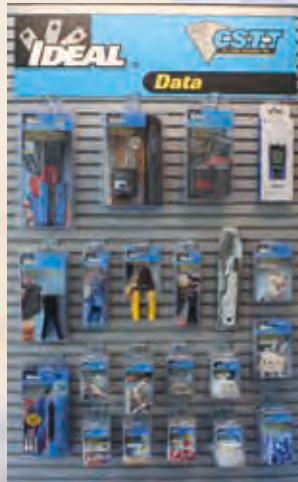

DATAKOM PROFILE

IDEAL offers a complete solution for the network / data installer. Our range includes tools, connectors and network testers - cut, strip, terminate and test coaxial and twisted pair cables. Each profile is supported by POS materials including header boards and posters to create displays within displays.



LOCKOUT KITS

Lockout kits are merchandised using this high impact backing board. Designed to display the most popular lockout kits, this backing board fits on any configuration of slat wall. It also drives additional sales of lockout/tagout products such as safety padlocks and spare MCB lockout devices.



POSTERS

Using posters is an effective way to create more interesting and eye catching displays. IDEAL offers a range of posters designed to support products on display and generate product awareness and incremental sales on non-stocked products.



1M DISPLAY STAND

A 1m metal slat wall display stand is available to support the merchandising and sales of IDEAL products. These illuminated stands are perfect for displaying a range of core IDEAL profiles such as lockout kits, DataCom, wire connectors and cable installation products.

Visit our website
www.idealindustries.co.uk



Wire Termination



Cable Installation



Lockout/Tagout



Test & Measurement



Datacom/
Network Testers



IDEAL
Electrical Catalogue

IDEAL INDUSTRIES LIMITED

Unit 3, Europa Court, Europa Boulevard, Westbrook, Warrington, WA5 7TN, U.K.
Tel.: +44 (0)1925 44 44 46 • Fax: +44 (0)1925 44 55 01 • Email: electrical.enquiries@idealnwd.com

For complete sales office contact information, visit us at:

www.idealindustries.co.uk

IDEAL, an American Original

We listen, and we deliver products with a purpose.

J. Walter Becker founded IDEAL in 1916 and made a promise that is still an important part of the way IDEAL operates today: "An IDEAL product will provide a value greater than the price paid for it. Service is a part of the product." Becker's founding principle represents our everyday commitment to you. It's the driving force behind our partnerships with the world's leading distributors, a state of the art delivery system, outstanding customer and technical support and variety of operational benefits designed to save time and money.

It means we're proud of the way we do business.

With headquarters located in Sycamore, Illinois, IDEAL also has European operations in the UK, Germany and France.

Today's global economy demands we look at doing business more creatively, more competitively and more efficiently. IDEAL is on the leading edge of product development and design, integrating those ideas through strategic investment, implementation of lean manufacturing and just-in-time inventory. Field-tested and customer influenced design means we are creating some of the most forward thinking product designs in the industry.



IDEAL is with you every step of the way

In-Sure™ & Twister® wire connectors, Yellow 77® wire pulling lubricant, T®-Stripper wire strippers, SignalTEK network testers and SureTrace® & TightSight® electrical testers are products which have found their way into the tool bags of electrical and networking professionals and solidified the IDEAL reputation as a manufacturer of innovative and trustworthy products.

Through ingenuity, proven performance and innovative engineering, IDEAL continues to lead the electrical industry with products that deliver value greater than the price paid for them.



TERMINATION TECHNOLOGY

Designed to exacting European safety standards, IDEAL manufactures a connector that's right for every job – fast, safe, reliable connections every time.



WIRE PULLING LUBRICANT

The No.1 brand of wire pulling lubricant. Environmentally safe, IDEAL lubes provide exceptional lubricity for super-fast cable pulls through conduit and ducting.



LOCKOUT/TAGOUT

IDEAL offers a comprehensive range of electrical lockout/tagout products that provide cost-effective solutions for managing electrical safety and circuit isolation.



TEST & MEASUREMENT

From our innovative SureTrace™ Circuit Tracers to the award winning TightSight® Clamp Meters, IDEAL develops test instruments that do the job faster, safer and easier.



DATACOM/ NETWORK TESTERS

From copper to fibre, twisted pair to coax, IDEAL offers everything you need for the installation, termination, testing and troubleshooting of modern LAN, CCTV and audio/video installations.

TABLE OF CONTENTS

A WIRE TERMINATION

In-Sure™ Push-In Wire Connectors	A-2
In-Sure™ Lever Wire Connectors	A-3
SpliceLine™ In-Line Wire Connectors	A-4
Twister® & WeatherProof® Wire Connectors	A-5
Wire Connector Kits	A-6

B CABLE INSTALLATION

Fish Tapes	B-2
Wire Pulling Lubricants	B-4
Duct Seal & Anti-Oxidant Compound	B-5
Conduit Benders	B-6
Wire Strippers	B-7
Cable Cutters	B-9
Quick Change Screwdriver	B-13
Hand Tools & Hack Saw	B-14

C LOCKOUT/TAGOUT

Lockout/Tagout Kits	C-2
Padlocks & Hasps	C-4
Lockout Devices	C-4
Lockout Devices & Accessories	C-6

D TEST & MEASUREMENT

Selection Guide & Safety	D-2
Clamp Meters	D-3
Multimeters	D-4
Voltage Testers/Light Meter	D-5
SureTrace™ Circuit Tracers	D-6
Digital Circuit Breaker Finder	D-8

E DATACOM/NETWORK TESTERS

LanTEK® III LAN Cable Certifiers	E-2
SignalTEK CT Cable Transmission Tester	E-3
SignalTEK NT Network Transmission Testers	E-4
NavITEK NT Network Troubleshooters	E-4
VDV II LAN Cable Verifiers	E-5
Fibre Optic Testers	E-6
SecuriTEST™ PRO CCTV Tester	E-7
Network Tester Accessories	E-7
Crimp Tools/Other Testers	E-8
Crimp Tools/Punch Down Tools	E-9
Compression Connectors	E-11
Coax Installation Kits	E-14
FT-45™ Modular Plug Crimp Tool	E-15
Feed-Thru and standard Cat 5e/Cat6 Modular Plugs	E-15
Cable Strippers	E-16
Data Cutter & Network Tester Accessories	E-17





NEW

NEW PRODUCTS FROM IDEAL

For almost 100 years IDEAL has served the electrical market and continues to take pride in innovation that delivers unrivalled value, quality and exceptional performance. Engineered specifically for the professional electrician, IDEAL is committed to providing new products that deliver durability, on the job efficiency and safety.

Every IDEAL product is covered by a comprehensive warranty.



NEW
Enhanced
Performance

SURETRACE™ CIRCUIT TRACERS

CertainCircuit™
After you identify and trip the correct breaker, the transmitter senses the loss of power and sends a different signal back to the receiver to give you confidence at the panel that the right circuit was de-energised.



Energised



De-energised



See Page D-6



InSITE
TECHNOLOGY

INSITE® COMPRESSION CONNECTORS

Featuring a 360° clear site window that simplifies the connector to cable installation.



NJX™ COMPRESSION CONNECTORS

offer a high performing, reliable and economical solution designed for applications that do not require weatherproof connectivity.



TLC™ COMPRESSION CONNECTORS,

our simplest, fastest and lowest total cost solution for installing compression connectors. Designed to save Time, Labour and Cost!



See Page E-11



VDV II TESTERS

- Three new Voice-Data-Video verification testers
- New test features including TDR length measurement, Ethernet service detection, PoE solicit and detect with voltage measurement, and more
- New multi remote and identifier accessory packs
- Visit www.vdvii.com for more details

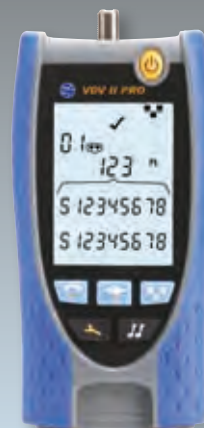

See Page E-5

THERE'S A BETTER WAY TO CUT



Designed to cut 380 mm² (750 KCMIL MCM) and smaller hard-drawn copper and aluminium cables. The hardened steel blades ensure consistent cuts and long-term durability. The rounded blade design minimises cable distortion during cutting and the quick release mechanism simplifies blade back-out. The locking mechanism keeps handles closed for easy storage and the moulded-in foot provides stability and leverage when making multiple cuts.



See Page B-12

PowerBlade™ 750 CABLE CUTTER

With adjustable torque arms, heavy duty gears and state of the art hardened steel blades, IDEAL PowerBlade™ Cable Cutters offer ease of use and unsurpassed performance. The PowerBlade™ 750 is extremely versatile and designed for multiple applications. With a jaw opening of 38 mm (1.5") and specially hardened, rounded blades cable distortion is minimised for professional quality every time. This PowerBlade™ has the ability to cut up to 380 mm² (750 MCM) copper cable and 506 mm² (1000 MCM) aluminium cable.



See Page B-10

**POWERBLADE™ CUTS
COPPER CABLE UP TO
380 MM² (750 MCM)
AND ALUMINIUM UP TO
506 MM² (1000 MCM)**

**38 MM
1.5" MAX JAW
OPENING**



Connectors designed for every application

In-Sure™ Push-In Wire Connectors

The fastest, easiest, push-in connector on the market, the In-Sure™ push-in wire connector can reduce installation time by up to 50% compared to more traditional connection methods.

Our 2, 3 & 4 port connectors are uniquely rated to 32 Amps making them suitable for a broad range of wiring applications. In-Sure™ connectors are the perfect replacement for crimped splices.

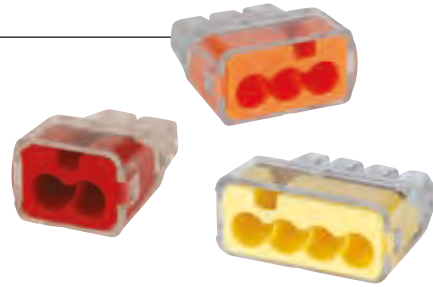

In-Sure™ Lever Wire Connectors

The new In-Sure™ lever wire connectors are the perfect solution for joining solid, stranded or flexible conductors. When used with rigid wires there is no need to touch the blue levers because they operate just like standard push-in connectors. Lifting the levers permits fast insertion of flexible wires and the removal of both flexible and rigid wires.

Suitable for use in a wide variety of installation and lighting applications these connectors are available in 2, 3 and 5-port variants that accommodate wires sizes up to 2.5 mm². Featuring a transparent housing that allows visual inspection of the wires and a compact design that takes up less room in junction boxes and enclosures, In-Sure™ lever wire connectors are the versatile all-rounders.

SpliceLine™ Wire Connector

SpliceLine™, a revolutionary in-line wire connector. Utilising patented push-in technology, the unique design provides a crimp-free, solderless butt splice making application easier and faster. The 2-port model supports a wide range of either stranded or solid wires, allowing one connector to cover the same wire range as multiple butt splices.

The end-to-end connection of SpliceLine™ is a great solution for today's pre-fab operations and also makes it perfect for lengthening short wires in tight spaces. It easily passes through standard knock-outs and the transparent polycarbonate allows for visual inspection, assuring a secure connection every time.



Twister® Wire Connectors

Accommodating the majority of common wiring configurations from 0.5mm² - 10.0 mm², the ribbed cap provides a secure grip and swept wings offer extra leverage. A patented square-wire spring provides safe, secure connections. Conforming to BS EN 60998 Twister® wire connectors fully comply with BS 7671:2008 (17th Edition Wiring Regulations).

A cost-effective and flexible solution, Twister® connectors are rated up to 57 Amps, will accept solid and stranded wire and have the added advantage of being re-usable, making them the obvious alternative to terminal blocks.

WeatherProof® Wire Connectors

Connected and Protected in one easy step. Designed specifically for above ground, interior/exterior connections exposed to damp/wet and corrosive environments.

Each connector is pre-filled with 100% silicone-based sealant which gives them their IP55 rating. Several models handle a variety of wire sizes from 1.5mm² - 4.0mm², making them ideal for use in gardens, garages and patio areas, as well as in commercial and industrial environments.

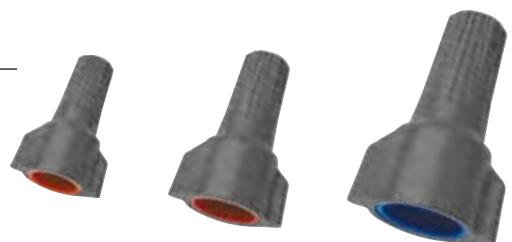

WIRE TERMINATION

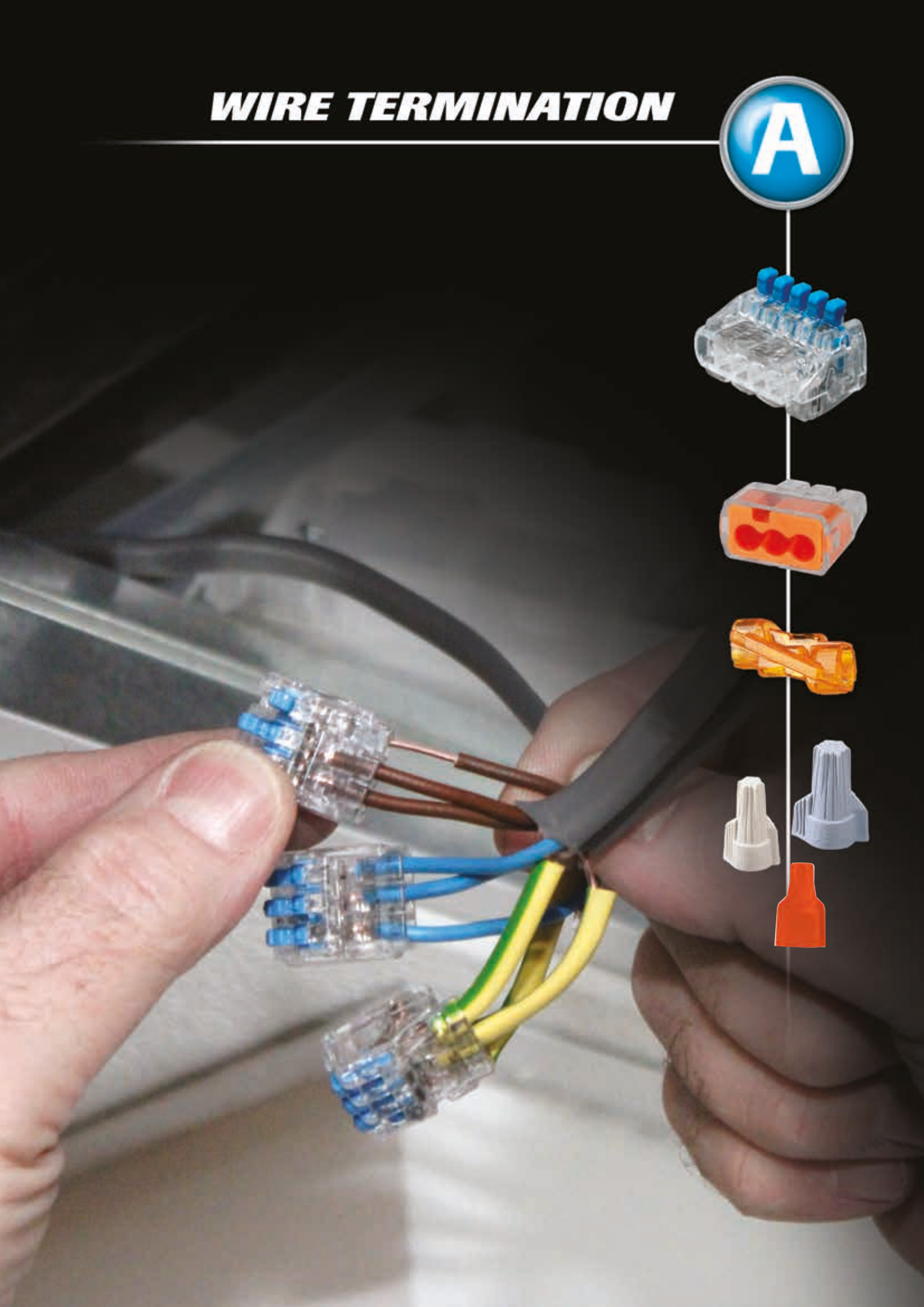

In-Sure® Push-In Wire Connectors

The In-Sure® push-in wire connector can reduce installation time by up to 50% compared to more traditional connection methods such as terminal blocks. In-Sure® connectors are the perfect replacement for crimped splices. In addition the most popular 2, 3 & 4 port models are rated to 32 Amps.

- Fits any combination of 0.75mm² - 4.0mm² solid or 1.5mm² - 2.5mm² stranded (≤ 7 strands) copper conductors or tin bonded flexible wire
- 32 Amp rating on 2, 3 and 4 port models
- High quality, secure connections
- Clear shell allows verification of connection
- Ergonomic design for easy grip and comfort
- Low insertion force for fast connections
- Continuity test port
- Colour coded for easy identification
- BS 7671:2008 (17th Edition) compliant
- Conform to EN 60998-1 and EN 60998-2-2 connecting device standards

Strip, Push, Connect
The Fastest Way To Make A Connection

Push-In

FAST FACT:

The In-Sure® Push-In has a low insertion force for fast, easy connections. Great for junction boxes.

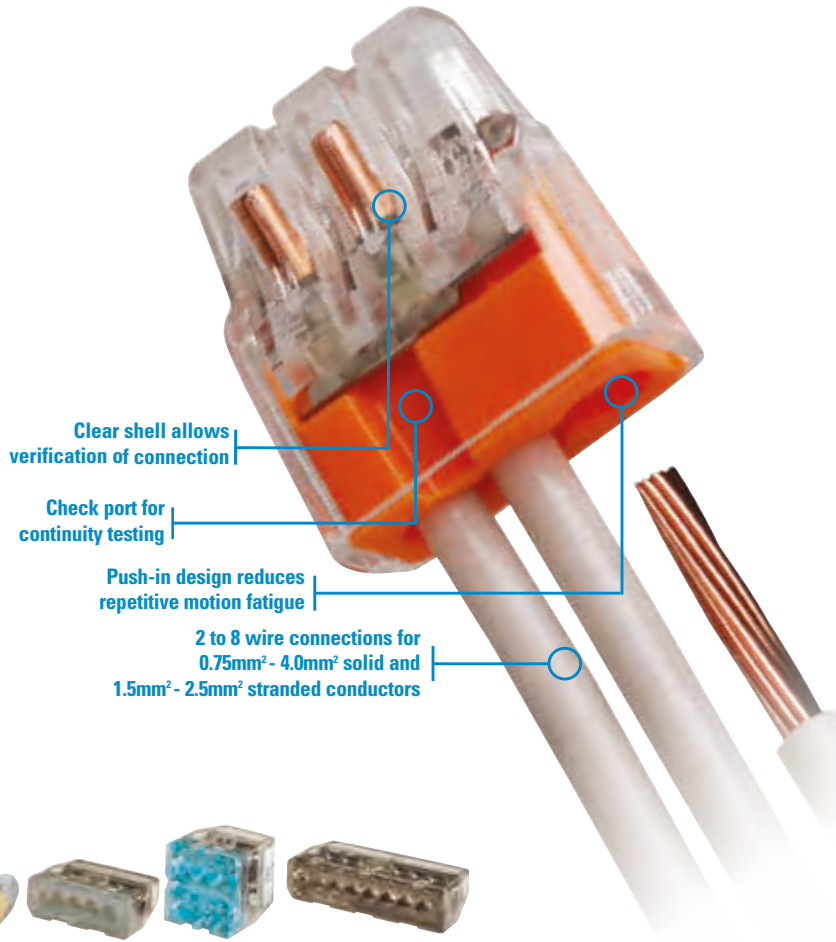

Specifications

	Model 32 Red 2-Port	Model 33 Orange 3-Port	Model 34 Yellow 4-Port	Model 87 Grey 5-Port	Model 88 Blue 6-Port	Model 90 Black 8-Port
Rating	32 Amp / 450V / 105°C maximum			24 Amp / 450V / 105°C maximum		
Depth	19.81 mm			18.52 mm	18.52 mm	18.21 mm
Width	13.21 mm	17.53 mm	20.83 mm	23.03 mm	15.32 mm	35.03 mm
Height	9.65 mm			9.02 mm	15.42 mm	9.02 mm
Wire Combination Range	Solid wire	0.75mm ² to 4.0mm ²			0.75mm ² to 4.0mm ²	
	Stranded wire*	1.5mm ² to 2.5mm ²			1.5mm ² to 2.5mm ²	

* Stranded wire is limited to ≤ 7 strand

Ordering Information

Model	Colour	Ports	Quantity	Cat. No.
32	Red	2	Box of 100	30-1032
33	Orange	3	Box of 100	30-1033
34	Yellow	4	Box of 100	30-1034
87	Grey	5	Box of 50	30-087
88	Blue	6 Stacked	Box of 50	30-088
90	Black	8	Box of 50	30-090

COPPER TO COPPER ONLY. Do not use on aluminium.



In-Sure® Lever Wire Connectors

The In-Sure® lever wire connectors provide the perfect solution for joining solid, stranded or flexible conductors.

These versatile connectors have a compact design that takes up less room in junction boxes and enclosures.

- Releasable connector for solid, stranded and flexible wires
- Wire clamping range: 0.2mm² – 2.5mm²
- Modern alternative to traditional strip connectors
- Safe, reliable and re-useable
- Works just like a standard push-in connector with solid and rigid stranded wires
- Clear shell allows verification of connection
- Continuity check port
- Strip length guide
- Compact design suits tight spaces
- No screwdriver required
- BS 7671:2008 (17th Edition) compliant
- Conform to EN 60998-1 and EN 60998-2-2 connecting device standards

Solid, Stranded or Flex The Versatile All-Rounder

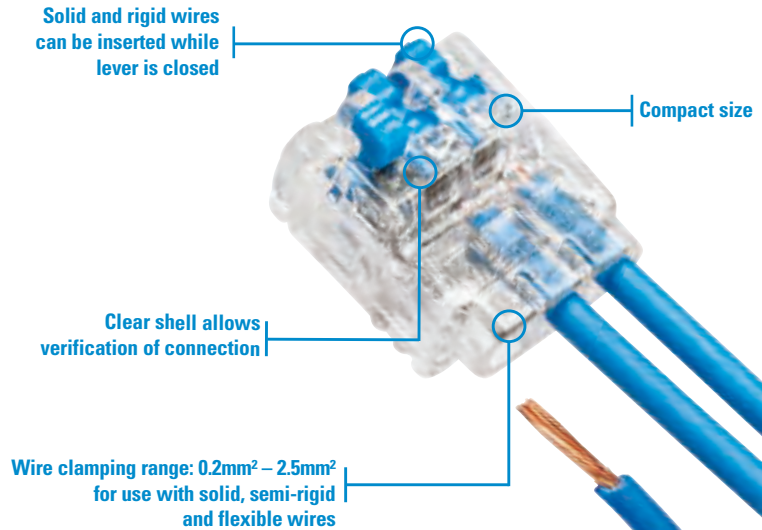

Specifications

	Model 52 2-Port	Model 53 3-Port	Model 55 5-Port
Rating	24 Amp / 450V / 120°C		
Depth	21 mm		
Width	11.9 mm	16.1 mm	24.5 mm
Height	11.7 mm		
Wire Combination Range	Solid, Rigid Stranded and Flexible Wires		
	0.2mm ² -2.5mm ²		

Ordering Information

Model	Ports	Quantity	Cat. No.
52	2	Box of 40	30-1052
53	3	Box of 40	30-1053
55	5	Box of 30	30-1055
59	Mixed	Combo Box: 10 x 2-port 10 x 3-port 10 x 5-port	30-1059



Lever

FAST FACT:

The In-Sure® Lever Connectors are ideal in lighting applications where you may have to join solid and flexible wires together.



SpliceLine® In-Line Wire Connectors

The SpliceLine® in-line wire connector provides a crimp-free, solderless butt splice. Conforming to BS 7671:2008, the two-port model accepts up to 4.0mm² solid wire, allowing one connector to do the job of multiple through-crimps. Its end-to-end connection is also a great solution for pre-fab operations.

- 32A rating
- Tool-free, push-in through crimp
- Easily passes through standard knockouts
- End-to-end connection ideal for pre-fab operations
- Transparent polycarbonate window for visual inspection of connection
- Wide wire range of: 0.5mm² to 4.0mm² solid
- BS 7671:2008 (17th Edition) compliant
- Conform to EN 60998-1 and EN 60998-2-2 connecting device standards

A Faster Butt Splice A Better Butt Splice

Transparent polycarbonate shell allows for visual inspection of connection

Check port for continuity testing

Accepts solid or stranded* wire

Slim design fits through standard knockouts



Scan for product video

SpliceLine® IN-LINE WIRE CONNECTORS

FAST FACT:

Perfect for lengthening short wires, the SpliceLine® is 3X faster than traditional butt-splices.



Model	Colour	Rating	Wire Range	Quantity	Cat. No.
42	Orange	32A 450V 105°C	Solid: 0.5mm ² - 4.0mm ² Stranded*: 1.0mm ² - 2.5mm ²	Bag of 10	30-1342S
				Box of 100	30-1042

* Stranded wire is limited to ≤ 7 strands



Twister® Wire Connectors

The No.1 twist-on wire connector. The Twister® easily handles the most common wiring tasks. A patented, expanding square-wire spring always ensures a quick, safe connection.

- Exceptional wire-range capacity – three colour-coded models handle wire combinations from as small as 0.5 mm² to as large as 10.0 mm²
- Accept solid, stranded and flexible wires and are reusable
- Swept wings offer extra leverage and less effort for large wire combinations
- Live-action, square-wire spring locks onto wire for safe, secure connections
- Deep skirt helps protect against flash-over and turned-back strands for maximum dielectric protection
- Cost effective replacement for terminal blocks
- BS 7671:2008 (17th Edition) compliant
- Conform to EN 60998-1:2004, EN 60998-2-4:2005 connecting device standards

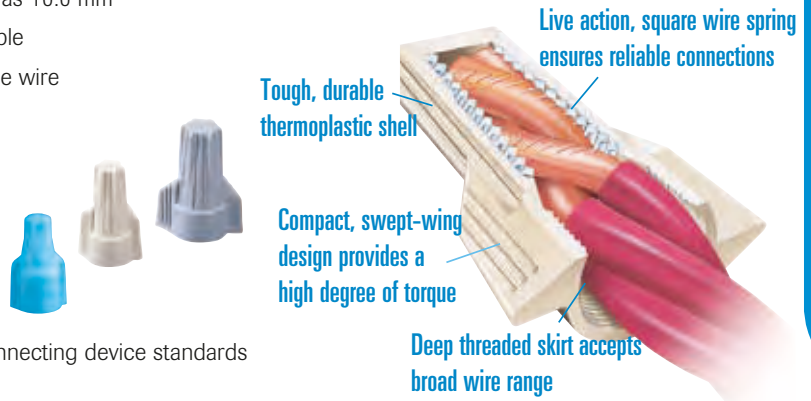

Optimum Wire Range

Ultimate Performance

Wire Connectors

Model	Colour	Wire Combination Range (mm)	Quantity	Cat. No.
340®	Lt. Blue	32A / 450V 0.5mm ² to 4.0mm ² Min. 2 x 0.5mm ² Max. 2 x 4.0mm ²	Box of 100	30-340
341®	Tan	41A / 600V 0.5mm ² to 6.0mm ² Min. 3 x 0.5mm ² Max. 2 x 6.0mm ²	Box of 100	30-341
342®	Grey	57A / 600V 2.5mm ² to 10.0mm ² Min. 3 x 2.5mm ² Max. 2 x 10.0mm ²	Box of 50	30-342
344®	Red/Yellow	32A / 600V 0.5mm ² to 4.0mm ² Min. 3 x 0.5mm ² Max. 4 x 4.0mm ²	Box of 50	30-144

Twister®

FAST FACT:

The small profile of the Model 340 Twister® means it easily fits inside standard connector enclosures.

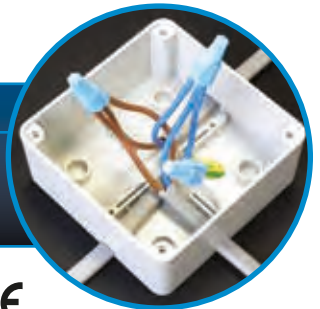

WeatherProof Wire Connectors

Designed specifically for above ground, interior/exterior connections exposed to damp/wet and corrosive environments.

WeatherProof connectors are pre-filled with a non-hardening, silicone-based sealant that protects against moisture and corrosion.

- Silicone-based sealant protects against moisture and corrosion
- IP55 rated for use in damp/wet locations
- Easy to apply, pre-filled twist-on wire connectors
- Accept solid and stranded wire
- Handle wire sizes from 1.5mm² to 4.0mm² copper conductors
- Tough, UL 94V-2 flame-retardant shell rated at 105°C (221°F)
- BS 7671:2008 (17th Edition) compliant
- Conform to EN 60998-1:2004, EN 60998-2-4:2005 connecting device standards

Connected and Protected

Damp/Wet Above Ground Locations



Model 61
24A/450V

Model 62
32A/450V

Model 63
32A/450V

WeatherProof

FAST FACT:

The silicone-based sealant protects electrical connections, eliminating the need for heat-shrink or water-proof enclosures in many applications.



WeatherProof Wire Connectors

Model	Colour	Wire Combination Range (mm ²)	Quantity	Cat. No.
61	Grey/Orange	1.5mm ² to 2.5mm ² Min. 1 x 1.5mm ² / Max. 2 x 2.5mm ²	Card of 25	30-1161
62	Grey/Red	1.5mm ² to 4.0mm ² Min. 2 x 1.5mm ² / Max. 4 x 4.0mm ²	Card of 20	30-1162
63	Grey/Dr. Blue	2.5mm ² to 4.0mm ² Min. 3 x 2.5mm ² / Max. 6 x 4.0mm ²	Card of 15	30-1163

Wire Connector Kits

IDEAL offers a range of wire connector kits comprising of In-Sure® Push-In, SpliceLine® In-Line, In-Sure® Lever Wire, Twister® and WeatherProof wire connectors.

These kits meet the needs of today's modern electricians who demand quality products that satisfy the requirement to make safe and reliable connections of wires in a variety of wiring applications.

Ordering Information for kits

Model	Description	Qty.	Cat. No.
	32A Push-In Connector Installer Kit	30 x 2-port push-in 30 x 3-port push-in 30 x 4-port push-in 30 x SpliceLine®	30-5011EU
	In-Sure® Push-In Connector Premium Kit	50 x 2-port push-in 50 x 3-port push-in 50 x 4-port push-in 40 x 5-port push-in 20 x 6-port push-in 15 x 8-port push-in 30 x Twister® 341 (FOC)	30-5020EU
	In-Sure® Push-In Connector Starter Kit	30 x 2-port push-in 30 x 3-port push-in 30 x 4-port push-in 20 x 6-port push-in	30-5021EU
	Push-In & Lever Wire Connector Kit (80 pcs.)	10 x 2-port lever connector 10 x 3-port lever connector 5 x 5-port lever connector 10 x 2-port push-in 10 x 3-port push-in 10 x 4-port push-in 10 x 6-port push-in 15 x 2-port SpliceLine®	30-5005EU
	Push-In & Lever Wire Connector Premium Kit (240 pcs.)	30 x 2-port lever connector 40 x 3-port lever connector 20 x 5-port lever connector 30 x 2-port push-in 30 x 3-port push-in 20 x 4-port push-in 15 x 5-port push-in 15 x 6-port push-in 10 x 8-port push-in 30 x 2-port SpliceLine®	30-5006EU
	Twister® & WeatherProof Connector Premium Kit	40 x Twister® 340® 40 x Twister® 341® 25 x Twister® 342® 25 x Twister® PRO 344® 20 x WeatherProof 61 12 x WeatherProof 62 12 x WeatherProof 63	30-5000EU
	Twister® & WeatherProof Connector Starter Kit	30 x Twister® 340® 30 x Twister® 341® 15 x Twister® PRO 344® 15 x WeatherProof 62	30-5001EU

CE

CABLE INSTALLATION

B



Tuff-Grip™ Pro... Industry's Leading Fish Tape!



**Length marked!
Now laser etched
in 12" increments
to provide instant
conduit length.**

Etched in (12") increments to provide instant conduit length.

Tuff-Cuff™ tape retaining feature keeps tape properly positioned in the opening.

Full-perimeter handle band helps keep dirt and moisture out, prolonging life.



Tuff-Grip™ Handle Large, comfortable ergonomically-designed, grasp from the top or side. Allows for use with gloves.

Superior pull-out and rewind characteristics.

Exceptionally Durable Case and Handle

Fish Tapes



Fish Tape Materials

Blued Steel™



- Laser etched in 12" increments to provide instant conduit length
- Unique finish is non-oily and resists rust
- Multiple options in width, length and eyelet for ease of use
- Industry's straightest wire
- Stiffer for long runs
- Highest grade carbon steel
- Tensile strength 725 kg (1,600 lbs.)

Zoom™

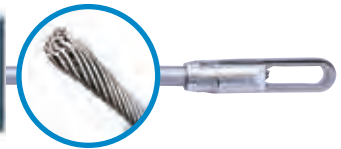

- 19 strands of stainless steel
- Ultra hard nylon jacket adds slipperiness, protects cables and user's hands
- Excellent for corrugated plastic conduit
- 19 strand twisted radial steel core encased in high molecular density outer jacket.
- Excellent for multiple bends or wet/corrosive work environment

Volt-Guard



- Non-conductive to 1000V
- Rectilinear profile for superior pushing power
- Designed for use around live circuits

Blued Steel™

Blued-Steel™ Fish Tapes

- Laser etched in 12" increments to provide instant conduit length
- High column strength for longer runs
- Non-oily finish resists rust

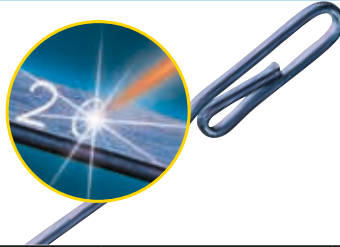

Length (m/ft.)	Width & Thickness mm / in	Case Diameter	End Type	Tuff-Grip™ Pro
Blued Steel™				
18 / 60	3.2 x 1.5 / 1/8 x .060	30 cm / 12 in.	Formed hook	31-055
36 / 120	3.2 x 1.5 / 1/8 x .060	30 cm / 12 in.	Formed hook	31-056
73 / 240	3.2 x 1.5 / 1/8 x .060	30 cm / 12 in.	Formed hook	31-057

Zoom™

Zoom™ Fish Tapes

- Great for hard to navigate conduit with multiple bends
- Nylon jacket protects the steel core while adding to the slipperiness of Zoom™

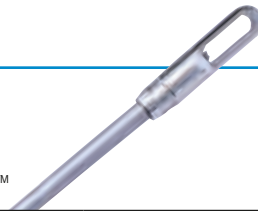

Length (m/ft.)	Width & Thickness mm / in.	Case Diameter	End Type	Tuff-Grip™ Pro
Zoom™ Nylon Jacketed Stainless Steel				
15 / 50	4.8 / 3/16 diameter	30 cm / 12 in.	Eyelet	31-090
30 / 100	4.8 / 3/16 diameter	30 cm / 12 in.	Eyelet	31-092

Volt-Guard

Volt-Guard Fish Tapes

- Non-conductive up to 1000V
- Elliptical design gives the Volt-Guard greater pushing power

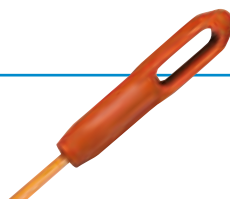

Length (m/ft.)	Width & Thickness mm / in.	Case Diameter	End Type	Tuff-Grip™ Pro
Fiberglass				
18 / 60	4.8 x 2.4 / .1875 x .094	30 cm / 12 in.	Eyelet	31-542
36 / 120	4.8 x 2.4 / .1875 x .094	30 cm / 12 in.	Eyelet	31-544

Aqua-Gel® II Cable Pulling Lubricant

- Polymer-based formula provides maximum tension reduction in high-stress electrical and communication cable-pulling operations
- Compatible with all cable types except composite rubber
- Cleans up easily with soap and water
- Clings to cable throughout long pulls
- Remains stable over wide temperature range – usable from -2°C to 88°C (28°F to 180°F)
- Dries to a semi-fluid film that won't clog conduit
- Easy to apply by hand, brush or pump
- Environmentally safe – non-toxic, non-flammable and non-corrosive
- Suitable for indoor or outdoor use



Description	Cat. No.
0.95 litre / 1-qt. Squeeze bottle	31-378

ClearGlide™ Wire Pulling Lubricant

- Clear and colourless for quick and easy clean-up – great for indoor and retrofit pulls
- Exceptional lubricity for super-fast pulls
- Polymer-based formula is perfect for all electrical and datacom applications
- Safe to use with all cable types
- Controlled evaporation rate is ideal for shorter runs
- Remains stable over wide temperature ranges – usable from -1°C to 82°C (30°F to 180°F)
- Dries to a semi-fluid film that won't clog conduit
- Easy to apply by hand, brush or pump
- Environmentally safe – non-toxic, non-flammable and non-corrosive



Description	Cat. No.
0.95 litre / 1-qt. Squeeze bottle	31-388

Wire Pulling Lubricant Selection Guide



	ClearGlide™ Wire Pulling Lubricant	Yellow 77® Wire Pulling Lubricant	Aqua-Gel® II Wire Pulling Lubricant
Colour	Clear	Yellow	Blue
Base	Polymer	Wax	Polymer
Average Coefficient of Friction*	0.23	0.17	0.19
Pull Length Up To	75 ft/22 m	1,200 ft/365 m	250 ft/76 m
Retains Pull Characteristics Up To	8 hours	24 hours	24 hours
Stability Range	32°F – 180°F (0°C – 82°C)	32°F – 130°F (0°C – 54°C)	32°F – 180°F (0°C – 82°C)
Application Temperature Range	40°F – 100°F (4°C – 38°C)	40°F – 100°F (4°C – 38°C)	40°F – 100°F (4°C – 38°C)
COMPATIBILITY (Cable Types):			
Rubber	•	•	•
Neoprene	•	•	•
Nylon	•	•	•
PVC	•	•	•
High-density or Cross-linked Polyethylene	•	•	•
Low-density Polyethylene	•	•	•
Semiconducting Jacket	•	•	•
Hypalon	•	•	•

*Results from NEETRAC, an independent testing laboratory affiliated with The Georgia Institute of Technology.

Yellow 77® Wire Pulling Lubricant

The no. 1 brand of wire pulling lubricant since 1959.

- The perfect general purpose lube
- Wax-based formula provides superior lubricity
- Safe to use with most cable types except low-density polyethylene and semi-conducting jackets
- Clings to cable throughout long pulls, even where moisture is present
- Won't break down or separate after repeated exposure to freezing temperatures
- Dries to a thin, non-conductive film
- Easy to apply by hand or brush
- Creamy texture applies easily and uniformly
- Homogeneous blend requires no mixing
- Won't dry out – surface coat forms to control evaporation
- Environmentally safe – non-toxic, non-flammable and non-corrosive



Description	Cat. No.
0.95 litre / 1-qt. Squeeze bottle	31-358
3.79 litre / 1-gal. Bucket	31-351
18.93 litre / 5-gal. Bucket	31-355

Duct Seal

- Seals around junction boxes, flashings and service entrances
- Permanently soft, non-toxic compound can be painted immediately after application
- Won't adversely affect other plastic materials or corrode metals



Description	Cat. No.
0.45 kg / 1 lb. Block	31-601
2.27 kg / 5 lb. Block	31-605

Selection & Application Guide



Web Based Selection & Application Guide:
<http://ideal.sdafiles.com>

Noalox® Anti-Oxidant

- Anti-oxidant and anti-seizing compound improves efficiency and service life of aluminium-to-aluminium and aluminium-to-copper electrical connections
- Suspended zinc particles penetrate and cut aluminium oxide
- Provides additional inter-strand and inter-conductor current paths for improved conductivity and cooler connections
- Carrier material excludes air to prevent further oxidation
- For use with all types of pressure-type wire connectors including screw-on, tap, service entrance and split-bolt
- Reduces galling and seizing and promotes good ground continuity on aluminium conduit joints



Description	Cat. No.
15 ml / 0.5 oz. Tube	30-024
118 ml / 4-oz. Squeeze bottle	30-026

For a Material Safety Data Sheet on Noalox® and other products check out:

<http://www.idealindustries.co.uk/support/msds/>



Duct Seal/Anti-Oxidant

Conduit Benders

- Exceptionally durable materials for extra strength
- Reinforced at stress points for longer life
- Markings are raised and cast into the bender body on both sides for easy visibility
- Deeply serrated step helps prevent slippage when applying force
- Grooved internal hook surface helps prevent conduit from slipping
- Flat hook surface provides stable starting point
- Much lower cost than stand mounted benders
- Takes up minimal space in vehicle
- Simple to use with no set-up required

Ductile Iron

- Withstands a lifetime of heavy use
- Ductile iron material is stronger than malleable iron or aluminium



Ductile Iron Head & Handle Complete

Conduit Type and Size	Cat. No.
20 mm / 3/4 in. steel conduit	74-027
25 mm / 1 in. steel conduit	74-028

Ductile Iron Head Only

Conduit Type and Size	Cat. No.
20 mm / 3/4 in. steel conduit	74-002
25 mm / 1 in. steel conduit	74-003



Handles for Benders

- Rugged, steel construction for long-term durability
- Baked-on blue enamel finish resists corrosion and enhances visibility
- Convenient bending guide for offset bends

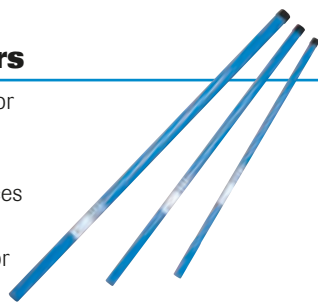

Conduit Type and Size	Cat. No.
20 mm / 3/4 in. steel conduit	74-019
25 mm / 1 in. steel conduit	74-020



Scan for product video



BenderBoot™

- Santoprene® tread and hand grip provides support for saddle and offset bends
- Easy push-on assembly to 1/2 in. and 3/4 in. bender handles



Description	Cat. No.
BenderBoot™	H-4076

Santoprene® is a registered trademark of Exxon Mobil



T[®]-Stripper Wire Strippers

Invented by IDEAL INDUSTRIES and manufactured at our facility in Sycamore, Illinois, USA, the T[®]-Stripper Wire Stripper line has been the industry standard for almost 50 years.

Compact, lightweight and easy to use. Features precision-ground, knife-type blades, built-in looping holes, wire cutters and a convenient plier nose.



- Form-ground, knife-type blades for accurate, easy stripping without nicking insulation
- Built-in wire cutter and looping holes
- Convenient plier nose for extra gripping strength
- Laser-etched wire gauge for easy-to-read visibility
- Spring-loaded automatic opening
- Corrosion-resistant, black oxide finish
- Tough steel construction

Description	Solid	Stranded	Cat. No.
T [®] -Stripper Wire Stripper – Metric	0.75-6.0mm ²		45-120-341
T [®] -Stripper Wire Stripper – Metric	0.5-4.0mm ²		45-125-341

Lil' Ripper Stripper™

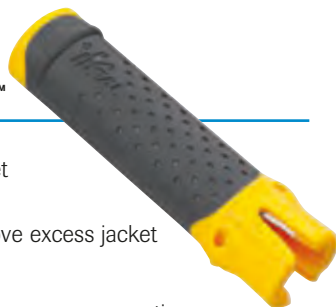

- Rips Twin & Earth outer jacket cleanly and quickly
- Clips outer sheathing to remove excess jacket
- Strips inner conductor wires
- Looping holes loop wire for screw-on connections
- Twist-Assist™ tightens most popular sizes of winged twist-on connectors
- Injection moulded elastomer grip provides a comfortable, slip resistant grip
- Strip length measuring scale allows for quick and easy measurements
- Conveniently fits in your pocket

Description	Cat. No.
Lil' Ripper Stripper™	45-025

Reflex™ Premium T[®]-Stripper Wire Strippers



- Ergonomic design for maximum comfort
- Curved handles reduce wrist fatigue
- Sleeves extend to stripping head to cushion thumb and fingers
- Textured, no-slip sleeves provide a sure, easy grip

Description	Solid	Stranded	Cat. No.
Reflex™ Premium T [®] -Stripper – Metric	0.5mm ² -4.0mm ²		45-425-341

7-in-1 Stripper



- Versatile, seven-function tool features precision-ground stripping blades, cushioned grips and plier nose
- Strips 1.5mm² - 6.0mm² solid and 0.5mm² - 4.0mm² stranded wire (AWG equivalents)
- Crimps bare and insulated terminals from 0.5mm²-5.0mm² wire, RG-59 coax connectors and 7 to 8mm auto ignition connectors
- Cuts unhardened wire, bolts and screws and reforms threads
- Reams and de-burrs conduit
- Gauges and loops wire

Description	Cat. No.
7-in-1 Stripper	45-777

Premium Insulated T®-Stripper Wire Stripper

The IDEAL insulated T®-Stripper creates a perfect blend of safety, comfort and precision functionality. Featuring double insulated Santoprene® handles with a soft, easy-to-grip outer surface, the insulated coating process acts as an 'at-a-glance' safety check. If the orange outer coating reveals any of the inner yellow surface, an electrician will know that this tool needs to be replaced.

- 1000 Volt certified (1000V AC, 1500V DC)
- Meets IEC 60 900 and ASTM F1505-01 standards
- Double insulated handles for added safety
- Form-ground, knife-type blades for accurate, easy stripping without nicking insulation
- Built-in wire cutter and looping holes
- Convenient plier nose for extra gripping strength
- Laser-etched wire gauge for easy-to-read visibility
- Spring-loaded automatic opening
- Corrosion-resistant, black oxide finish
- Locking tabs keep spring in place

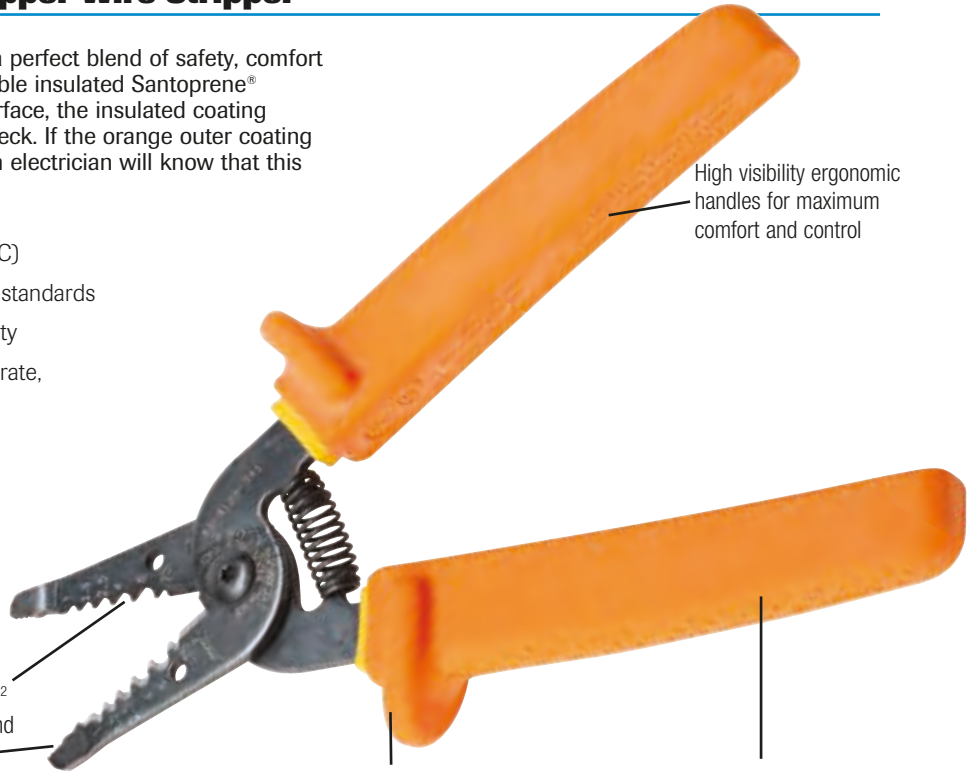

High visibility ergonomic handles for maximum comfort and control

0.75mm² to 6.0mm² stripping notches and plier gripping nose

Non-slip guard for added safety

Textured handles provide a sure grip and are resistant to perspiration, water, oil and chemicals

Description	Cat. No.
Premium T®-Stripper Wire Stripper - Metric 0.75mm ² -6.0mm ²	45-9120-341

Stripmaster® Wire Stripper

- One-step stripping enhances productivity
- Spring-action motion increases leverage and reduces operator fatigue
- Precision-ground, knife-type blades provide clean, accurate stripping
- Sturdy die-cast frame provides long-term durability
- Wire gripper holds wire securely in position



Knife-Type Blades for Metric Wire

Wire Size mm ²						Cat. No.
0.75 mm ²	1.0 mm ²	1.5 mm ²	2.5 mm ²	4.0 mm ²	6.0 mm ²	45-292-341

Twin & Earth Cable Stripper



- Self-adjusting stripping blades automatically select proper position
- Strips Twin and Earth cable
- Open-throat construction allows unlimited strip length
- Neatly removes outer cable sheath and inner wire sheathing to desired lengths
- Lightweight, ergonomic design reduces user fatigue

Description	Cat. No.
Twin & Earth Cable Stripper	45-235

T[®]-Cutter Wire Cutter



- Hardened steel, sheer-type blades
- Spring-loaded automatic opening
- Convenient plier nose for extra gripping strength
- Corrosion-resistant, black oxide finish
- Tough steel construction
- Locking tab keeps spring in place

Description	Cat. No.
T [®] -Cutter Wire Cutter	45-123

Long-Arm Cable Cutter



- High strength forged blades for ultimate durability
- Precision-ground jaws make clean cuts with minimal cable distortion
- Replaceable blades
- 1000 MCM (29.3 Dia.)
- For copper and aluminium only

Description	Length	Cat. No.
Long-Arm Cable Cutter	810 mm/32"	35-033

CAUTION: Comfort-grip handles are not designed for protection against electrical shock. Do not use on live circuits.

Data T[®]-Cutter Wire Cutter



- Cuts round communication cable and maintains cable geometry for better cable performance
- Cuts multi-pair cable up to 12.7 mm (0.5 in.) and coaxial cable up to RG-9/U
- Suitable for soft cables (not steel reinforced)
- Steel reinforced centre conductors can be trimmed with bolt cutting holes
- Cushioned comfort grip handles
- Locking latch keeps tool closed in pouch

Description	Cat. No.
Data T [®] -Cutter	45-074

PowerBlade™ Cable Cutter

The IDEAL PowerBlade™ Cable Cutter is designed to cut cables quickly and efficiently. With adjustable torque arms, heavy-duty gears and proprietary hardened steel blades, they deliver unsurpassed performance, ease-of-use and durability. Compatible with virtually any 12 volt or higher drill so that cutting is as effortless as pulling the drill's trigger. The unique compact design is the perfect tool for fitting into tight spaces. Features an ergonomic design and non-slip grips, helping you cut cable easily and safely.

Description	Cat. No.
PowerBlade™ 750 Cable Cutter	35-078

Not designed to cut SWA cable.

Cable Cutters



Scan for product video

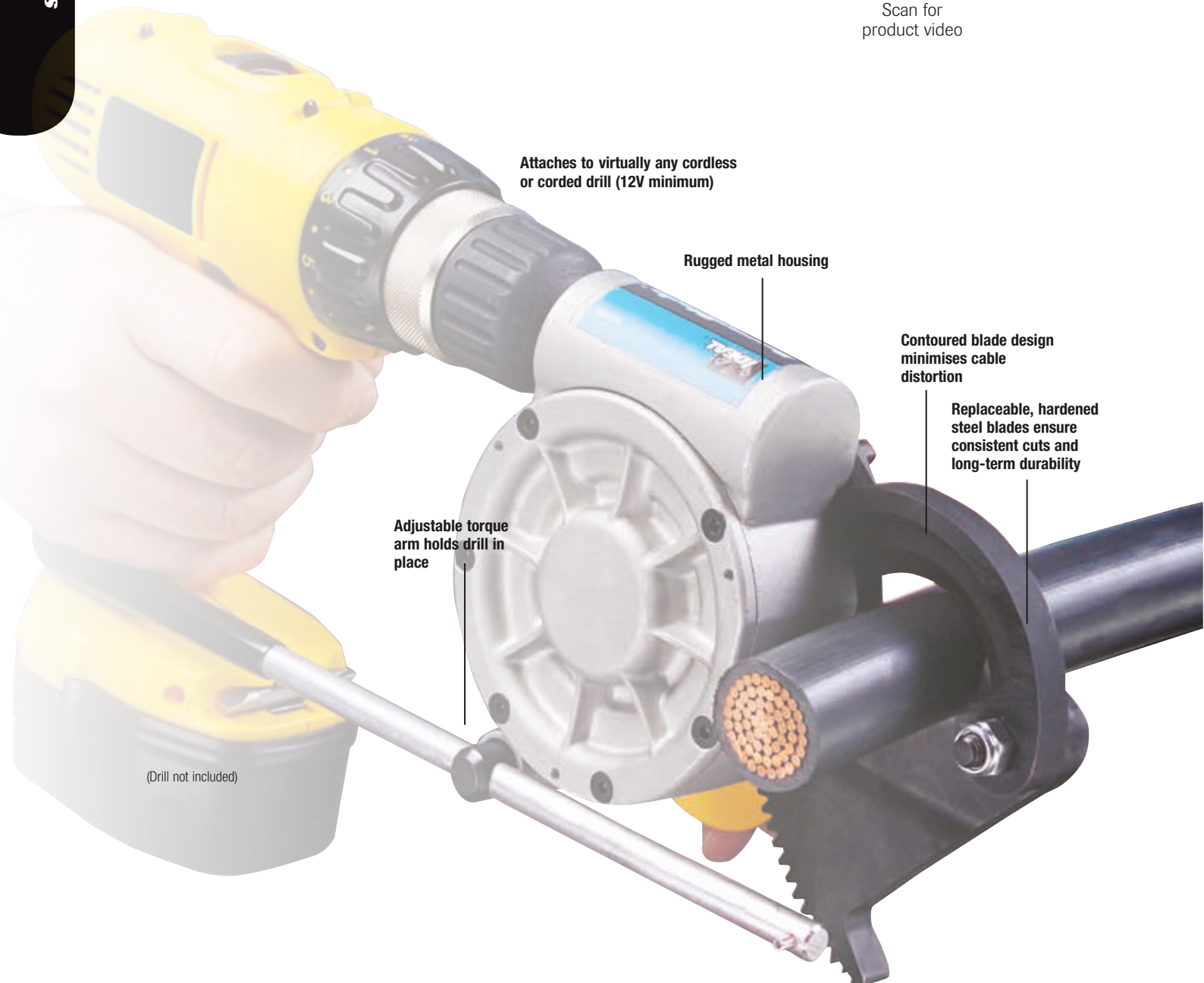

Attaches to virtually any cordless or corded drill (12V minimum)

Rugged metal housing

Contoured blade design minimises cable distortion

Replaceable, hardened steel blades ensure consistent cuts and long-term durability

Adjustable torque arm holds drill in place

(Drill not included)

PowerBlade™ 750 CABLE CUTTER



(Drill not included)

- Extremely versatile and designed for multiple applications
- Jaw opening of up to 1 1/2 inch (38mm).
- Cuts copper cable up to 380 mm² (750 MCM) and aluminium cable up to 506 mm² (1000 MCM)
- Specially hardened, rounded blades minimise cable distortion for professional quality every time



Cable Cutters

38 MM (1 1/2")

MAX JAW OPENING



Ratcheting Cable Cutter

- Designed to cut 380 mm² (750 KCMIL MCM) and smaller hard-drawn copper and aluminium cables
- Hardened steel blades ensure consistent cuts and long-term durability
- Rounded blade design minimizes cable distortion during cutting
- Quick release mechanism simplifies blade back-out
- Locking mechanism keeps handles closed for easy storage
- Moulded-in foot provides stability and leverage when making multiple cuts

Not designed to cut SWA cable.

Cable Cutters

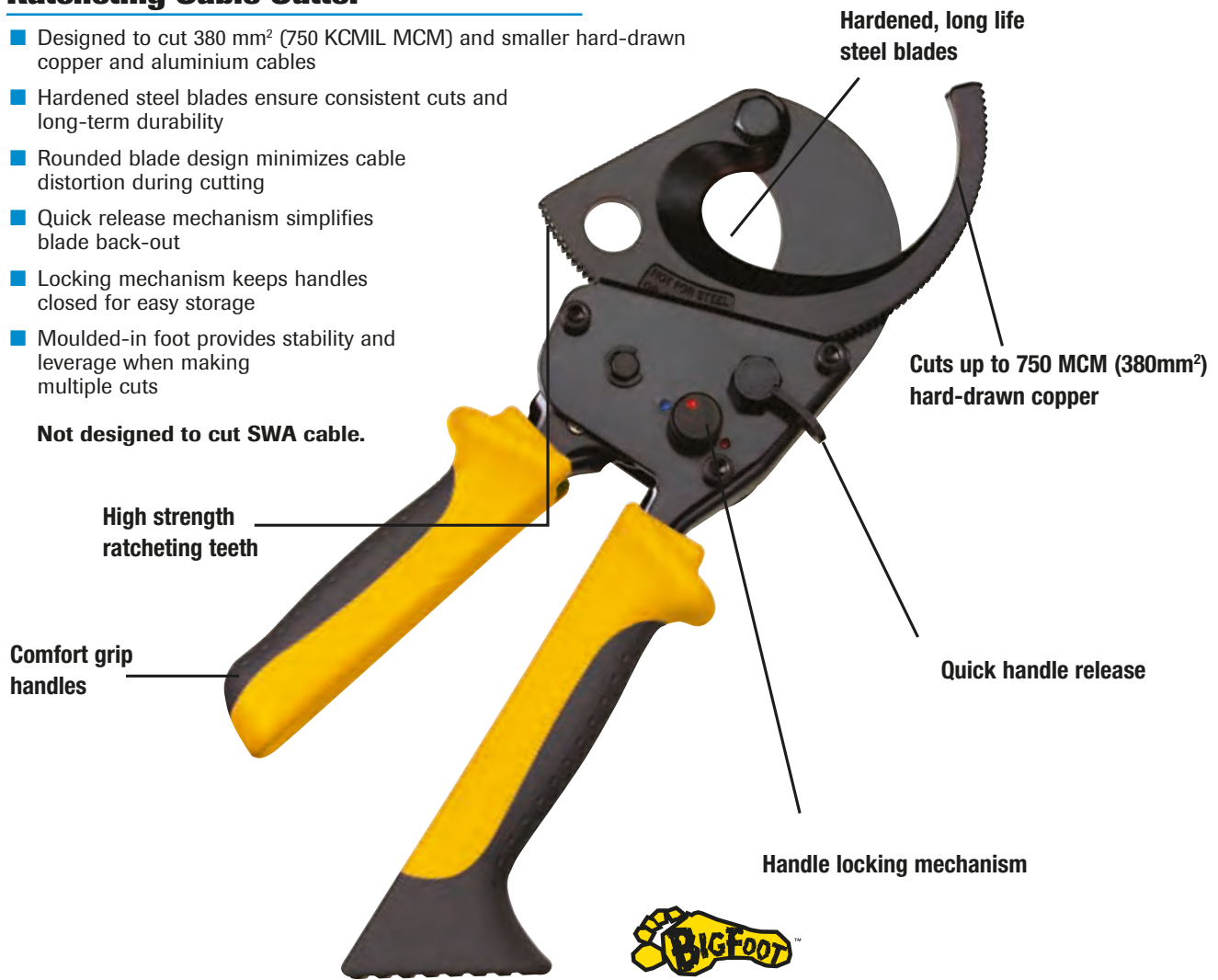

Description	Cat. No.
750 KCMIL (MCM) Ratcheting Cable Cutter*	35-053

*Max. Jaw Opening - 2 in. (50mm). Not for SWA cable.



Quick Change Screwdriver

The Quick Change Screwdriver is the ultimate multi-bit tool. Simply insert any standard bit into the socket or use as a 1/4" nutdriver. To switch to a different bit, pull back the gold knurled collar, remove the bit, and snap in another. This tool is as durable as it is useful. The driver blade has been coated in black oxide for superior corrosion resistance, and heat treated for optimum strength. Include this in your tool box as the most versatile screwdriver you will ever need!

- Patented Sure-Loc™ Quick Change chuck eliminates debris pick up as well as dropped bits
- Built-in bit storage container in handle holds up to five extra insert bits
- Bits fit all standard multi-bit screwdrivers
- E-Z Spin™ high torque rotating flip cap
- Patented design

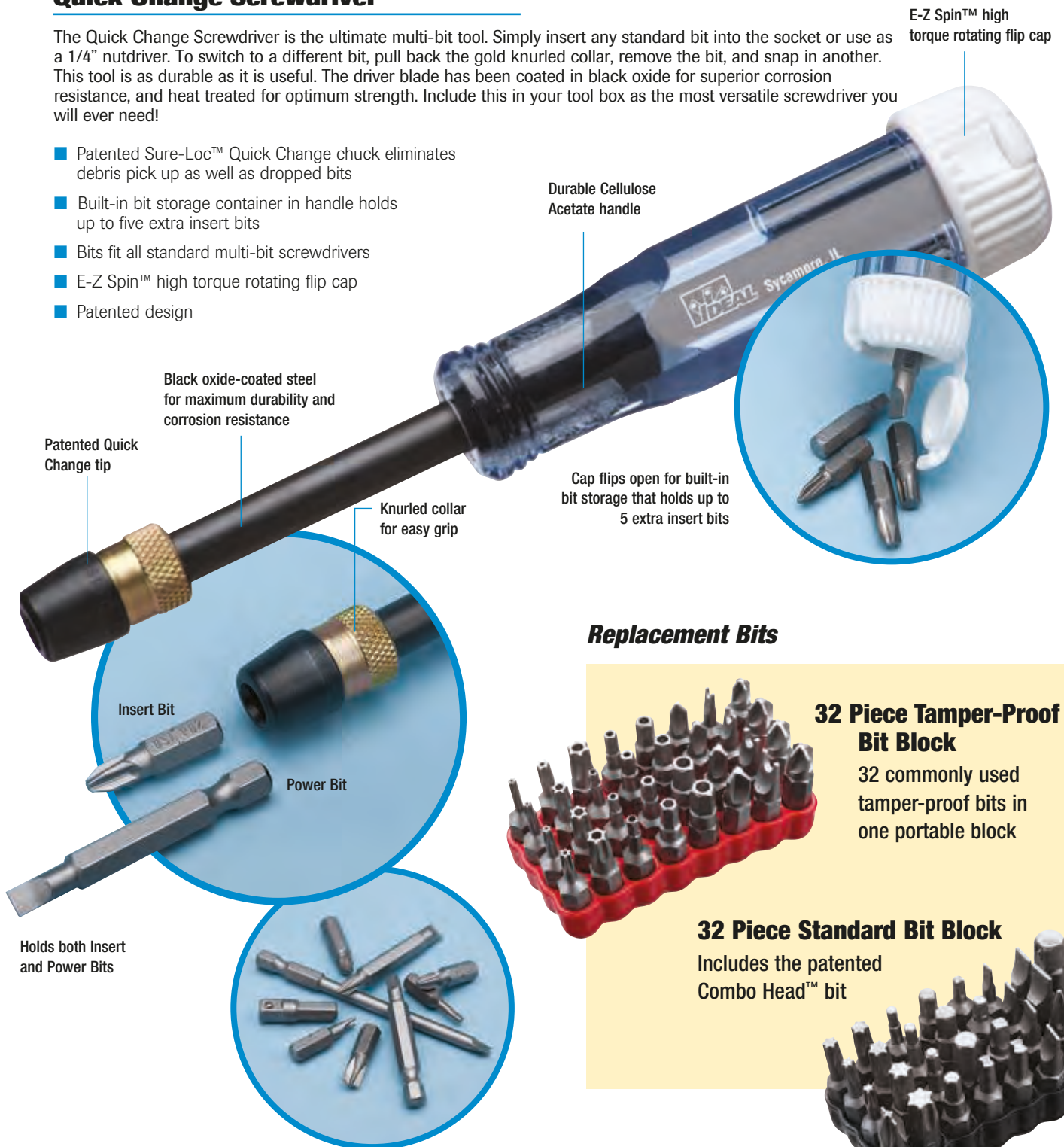

Replacement Bits

32 Piece Tamper-Proof Bit Block

32 commonly used tamper-proof bits in one portable block



32 Piece Standard Bit Block

Includes the patented Combo Head™ bit



The Quick Change Screwdriver accommodates a variety of bits



(Excludes Bits)



Scan for product video

Description	Blade Length	Handle Length	Overall Length	Cat. No.
33-Piece Quick Change Screwdriver Set - Quick Change Screwdriver and 32-Piece Tamper-Proof Bit Block	3-1/16 in.	4-3/16 in.	7-1/4 in.	35-933
33-Piece Quick Change Screwdriver Set - Quick Change Screwdriver and 32-Piece Standard Bit Block	3-1/16 in.	4-3/16 in.	7-1/4 in.	35-934

Auto-Lock™ Tape Measure 7.5m/25ft



- Automatic blade lock
- Push button for smooth blade retraction
- Nylon coated blade for extra long life and wear resistance
- Double sided marked blade for convenience
- Shock-resistant rubber grip for added comfort and protection

Description	Cat. No.
Auto-Lock™ Tape Measure 7.5m/25ft	35-242M

Safe-T-Grip® Fuse Puller

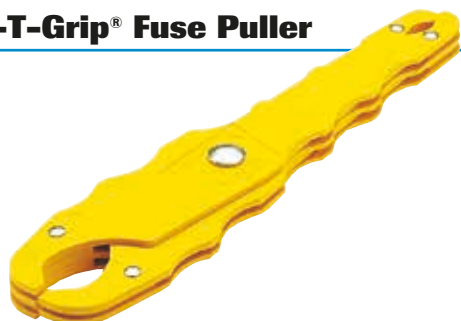

- Maximum efficiency and convenience for removing or replacing cartridge-type fuses
- Fully insulated, high-dielectric, glass-filled polypropylene construction
- Notched handles provide safe, no-slip grip
- Clearly marked amperage ranges
- Exceed MIL specifications

Description	Cat. No.
Medium Puller for 0 to 100A/250V & 600V, 1.3 cm (1/2 in.) to 2.5 cm (1 in.) dia. fuses; 19 cm (7-1/2 in.) long	34-002

Heavy-Duty Hacksaw

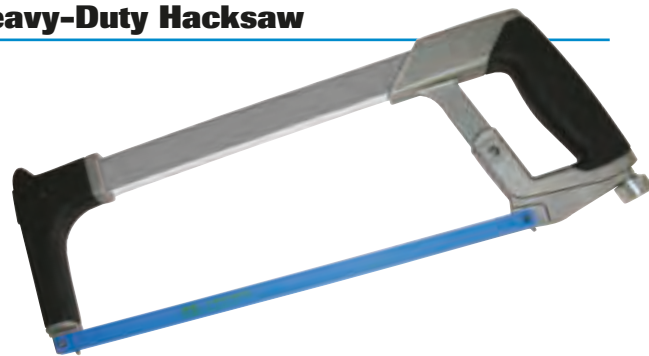

- Cushioned ergonomic grip for performance and comfort
- Rugged frame provides lightweight rigidity and exceptional control
- Stores up to nine extra blades
- Blades can be adjusted to 55° angle for flush cutting and tensioned to 30,000 psi
- Includes 300 mm / 12 in. x 24T bi-metal blade

Description	Cat. No.
Heavy-Duty Hacksaw	35-260

Ratchet Crimp Tool



- Crimps insulated or bare terminals and splices on 0.5mm² - 4.0mm² (10-22 AWG) wire
- Ratchet action prevents release prior to crimp connection – helps ensure uniform crimps
- Vinyl-coated handles provide a solid, comfortable grip

Description	Cat. No.
Ratchet Crimp Tool	83-001

Large Mouth Bag



- Top opens completely for easy access to large tools – reinforced to hold itself open
- Rugged zipper closure helps prevent tool loss
- Removable shoulder strap
- Durable multi-ply construction

Description	Cat. No.
Large Mouth Bag - 330 mm / 13 in. long	35-410

Note: Tools are not included.

LOCKOUT/TAGOUT



Importance of Safe Isolation

Unintentional energisation of circuits, machinery and equipment is a leading cause of death and injury among electrical contractors in the UK.

To minimise this type of accident regulations such as the “Provision and Use of Work Equipment 1998, Section 19 Energy” and the “Electricity at Work Regulations 1989, Regulation 13” require companies to have effective isolation policies in place.

Most accidents can be avoided by installing simple lockout / tagout devices prior to any electrical work being carried out.

Basic Practice for Safe Isolation

When working on electrical equipment / energized circuits, it is important that certain basic steps are followed:

- The correct point of isolation is identified
- An appropriate means of isolation is used
- Suitable caution notices should be placed where visible at the point of isolation
- All conductors must be proved to be dead at the point where work is intended to be carried out
- The electrical supply can not be reinstated while work is being carried out on any equipment / part of the circuit
- Isolation of equipment / circuits should be under the control of the person responsible for carrying out work on the isolated conductors
- Multi-lock hasps / devices should be used in the event of more than one person working on isolated equipment / circuits



IDEAL offers a range of lockout / tagout products to provide a cost-effective and safe solution in the management of electrical safety and circuit isolation in the workplace.

IDEAL lockout/tagout devices help to achieve compliance with current regulations.

For more comprehensive information on electrical safety and safe isolation, refer to the best practice guide available from the Electrical Safety Council entitled ‘Guidance on the **management of electrical safety and safe isolation** procedures for **low voltage installations**’. The latest version is available on the Electrical Safety Council website (www.esc.org.uk).

Kit Selection Chart

Part number	Description:	44-925	44-924	44-985UK	44-995
K-8334	Safety Padlock	✓	✓	✓	
K-40611	Non-Conductive Safety Padlock				✓
KB-0224	Steel Lockout Hasp		✓	✓	
44-428EU	Non-Conductive Lockout Hasp				✓
KB-0375	Circuit Breaker Lockout			✓	✓
IA-2280	“No-Hole” Lockout Device			✓	✓
441.001	MCB Pins-Out Device (Std)	✓	✓	✓	✓
441.002	MCB Pins-In Device				✓
441.003	MCB Pins-Out Device (Wide)				✓
441.004	Tie-Bar Lockout Device				✓
KB-0234	Universal MCB Lockout Device (Metal)	✓	✓	✓	✓
44-2393	Universal MCB Lockout Device (Plastic)				✓
44-2394	Universal MCB Lockout Device (Plastic)				✓
44-833EU*	Lockout Tags	✓ (1)	✓ (2)	✓ (5)	✓ (5)
KB-7566	Marking Pen		✓	✓	✓
IA-3240	Lockout Pouch		✓	✓	✓

* Available to order in packs of 5 (44-5833EU)

Contractor Lockout/Tagout Kit

- Aimed at contractors working on industrial, commercial and domestic installations
- Contains a range of devices allowing you to lock off most breakers on the market
- Supplied in a handy zipped pouch to help keep the kit close to hand and easily accessible



Description	Cat. No.
Contractor Lockout/Tagout Kit	44-985UK

Contractor PRO Lockout/Tagout Kit

- Aimed at contractors working on industrial, commercial and domestic installations
- Contains a broad range of devices allowing installers to provide safe isolation by locking off virtually all breakers on the market today
- Includes full range of MCB lockout devices including pins-in, pins-out, pins-out wide, tie-bar and various universal MCB lockout devices
- Supplied in a handy zipped pouch to help keep the kit close to hand and easily accessible



Description	Cat. No.
Contractor PRO Lockout/Tagout Kit	44-995

Domestic Installer Lockout/Tagout Kit

- Primarily aimed at the domestic installer
- Contains devices for use on typical breakers found in domestic installations
- Supplied in a handy zipped pouch



Description	Cat. No.
Domestic Installer Lockout/Tagout Kit	44-924

Personal Lockout/Tagout Kit

- A low-cost lockout kit containing two popular lockout devices plus a safety padlock and Do Not Operate tag
- Suitable for individuals or companies wishing to kit out their entire workforce with a low-cost versatile lockout kit



Description	Cat. No.
Personal Lockout/Tagout Kit	44-925

Safety Padlocks

- Dedicated safety lockout device reduces confusion with other locks
- Durable non-conductive, Xenoy lightweight body
- 6 mm triple-coated hardened-steel shackle
- Key retention ensures keys do not get lost while padlock not in use
- Complies with OSHA's "1-key, 1-lock"
- Available in various colours for easy identification



Description	Cat. No.
Safety Padlock 38 mm steel shackle - red	K-8334*
Safety Padlock 38 mm steel shackle - blue	K-8330
Safety Padlock 38 mm steel shackle - yellow	K-8336
Safety Padlock 76 mm long steel shackle - red	K-41021

* Available as blister packaging for retail display - add "-D" to the end of the part number

Non-Conductive Safety Padlocks

- Dedicated safety lockout device reduces confusion with other locks
- Non-conductive, Xenoy lightweight body
- 6 mm non-conductive nylon shackle
- Dielectric protection - anti-sparking
- Key retention ensures keys do not get lost while padlock not in use
- Complies with OSHA's "1-key, 1-lock"
- Available in red or yellow body
- Keyed-alike & Master-Keyed suites available by special order



Description	Cat. No.
Non-Conductive Safety Padlock 38 mm nylon shackle - red	K-40611
Non-Conductive Safety Padlock 38 mm nylon shackle - yellow	K-40612

Universal Hasp (Double Ended)

- Combines small and large hasp
- Allows up to six workers to lock out a single energy source
- Attach hasp to energy disconnect switch
- Control cannot be turned on until last worker's padlock is removed from hasp
- Hasp length 137 mm



Description	Cat. No.
Universal Hasp (Double Ended)	KB-0231

Steel Lockout Hasps

- Steel jaw with vinyl coated handle
- Allows up to six workers to lock out a single energy source
- Attach hasp to energy disconnect switch
- Control cannot be turned on until last worker's padlock is removed from hasp
- 25 mm and 38 mm dia. shackles available



Description	Cat. No.
Steel Lockout Hasp - 38 mm shackle	KB-0224*
Steel Lockout Hasp - 25 mm shackle	IA-5502

* Available as blister packaging for retail display - add "-D" to the end of the part number

Non-Conductive Logout Hasp

- Non-conductive, dielectric protection, anti-sparking
- Allows up to six workers to lock out a single energy source
- Attach hasp to energy disconnect switch
- Control cannot be turned on until last worker's padlock is removed from hasp
- Inside jaw 25 x 63 mm

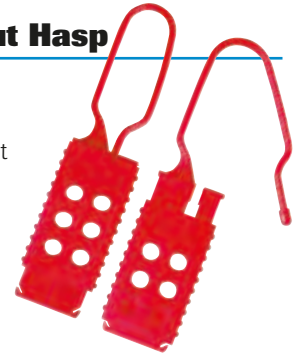

Description	Cat. No.
Non-Conductive Lockout Hasp	44-428EU

Mini-MCB Lockout Device

- Universal device that fits virtually all miniature circuit breakers in the market
- Cover easily pivots open and closed so the dial is inaccessible in the locked position to prevent removal
- Can be applied horizontally or vertically to lock out more than one breaker simultaneously
- Built from a durable, chemical resistant Zenx™ thermoplastic material



Description	Cat. No.
Mini-MCB Lockout Device	KB-1234

Circuit Breaker Lockouts

- Attaches securely to breaker with simple thumb turn and clamping handle
- KB-0226 is designed for breakers with wide or tall toggles
- KB-0227 fits standard height and tie-bar toggles
- The narrow profile permits side-by-side breaker lockout
- Durable construction with powder coated steel and reinforced polymer allows operation in harsh environments



Description	Cat. No.
Circuit Breaker Lockout Kit including one for wide & tall toggles and one for standard single & double toggles	KB-0375*
Circuit Breaker Lockout Kit for wide & tall toggles	KB-0226
Circuit Breaker Lockout Kit for standard single & double toggles	KB-0227

* Available as blister packaging for retail display - add "-D" to the end of the part number

"No-Hole" Lockout Devices

- Lockout device that is ideal for breakers without built-in locking facilities often found in older domestic and commercial installations
- Extremely versatile - works on wide range of single pole and internal-trip multi-pole breakers
- Use thumbscrews to clamp lockout securely onto switch tongue, then pull cover over thumbscrew and lock in place to prevent clamp from being loosened



Description	Cat. No.
"No-Hole" Lockout Device (max. switch 15 mm)	IA-2280
"No-Hole" Lockout Device (max. switch 38 mm)	LA-2182

MCB Lockout Devices

- A safe and effective method for locking out European Circuit Breakers
- The lockout easily installs with the aid of a Push Button
- Recommended to use in combination with a padlock with a shackle diameter up to 6 mm for added safety
- Requires no tools to install



Description	Cat. No.
MCB Lockout Device - Pins Out	441.001*
MCB Lockout Device - Pins In	441.002
MCB Lockout Device - Pins Out Wide	441.003

* Available as blister packaging for retail display - add "-D" to the end of the part number
+44 (0)1925 44 44 46 for Customer Service

Adjustable Cable Lockout

- Adjustable safety hasp and cable
- Ideal for locking out multiple breakers or side-by-side gate valves
- Device can be locked using four padlocks
- Can be adjusted once the cable is locked
- Durable, flexible multi-stranded 1.8 m long vinyl coated steel cable
- Tough, lightweight, dielectric Xenoy thermoplastic body withstands chemicals and performs effectively in extreme conditions



Description	Cat. No.
Adjustable Cable Lockout	44-808

Universal MCB Lockout Devices

- Universal MCB lockout devices useful for isolating MCB's without pin holes on the MCB switches
- Simple and easy to use



Description	Cat. No.
Universal MCB Lockout Device - metal	KB-0234*
Universal MCB Lockout Device - plastic, yellow (small)	44-2393*
Universal MCB Lockout Device - plastic, blue (large)	44-2394

* Available as blister packaging for retail display - add "-D" to the end of the part number

Tie-Bar Lockout Device

- A safe and effective method for locking out non-standard breakers where pins-in / pins-out devices can not be used
- Convenient thumb wheel for quick application
- Recommended to use in combination with a padlock with a shackle diameter up to 6 mm for added safety
- Requires no tools to install

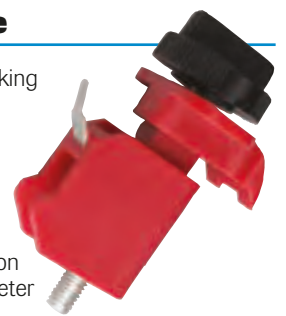

Description	Cat. No.
Tie-Bar Lockout Device	441.004

Lock Stations

- Integrated, one-piece moulded construction
- Resilient polycarbonate material provides heat resistance and high impact strength
- Lockable cover prevents loss of contents
- Secure with a combination lock for simple access control



Description	Cat. No.
5-10 Locks Lockout Station (Station Only)	44-778-S0
10-20 Locks Lockout Station (Station Only)	44-806-S0



Electrical Plug Lockouts

- Surrounds electrical plugs and prevents accidental reconnection
- Designed to enable installation in confined spaces
- Large plug lockout accepts various electrical plugs up to 500V and accommodates wide range of cable diameters
- Small plug lockout is perfect for safe isolation of appliances with a standard mains plug
- Locked out using safety padlock



44-0488



44-0487

Description	Cat. No.
Electrical Plug Cover (Small) 120V - 240V	44-0487
Electrical Plug Cover (Large) 220V - 500V	44-0488

DO NOT OPERATE Lockout Tags

- Heavy duty vinyl tag with metal grommet for extra strength
- Designed to withstand use in harsh environments
- High visibility lettering



Description	Cat. No.
DO NOT OPERATE Lockout Tags - Pack of 5	44-5833EU
DO NOT OPERATE Lockout Tag - 1 piece in blister packaging for retail display	44-833EU

Marking Pen

- Fast-drying, permanent ink will not smear
- For use on lockout tags, write-on marker cards and write-on cable-tie marker plates

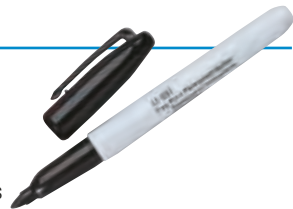

Description	Cat. No.
Marking Pen w/black ink	K-7566

IDEAL Pouch

- Durable zipped pouch
- Keeps your devices safe and helps preventing loss



Description	Cat. No.
IDEAL Pouch	IA-3240

Lockout Devices & Acc.

TEST & MEASUREMENT



TightSight® Clamp Meters 1000 & 660 Amp (770 & 760 Series)

- TightSight® bottom display
- Tapered jaws with hook tip
- Measures AC current
- True RMS
- AC/DC Voltage
- Capacitance
- Audible continuity
- Frequency via clamp head or test leads
- Resistance
- High frequency rejection*
- Peak hold
- Max/min hold
- Data hold
- Selectable audible and visual voltage alerts on AC/DC voltage functions
- Selectable auto power off
- Backlit display
- Low battery indicator
- 2-year warranty

*Reads accurately on noisy electrical circuits.



Description	Cat. No.
1000AAC Clamp Meter w/ differentiating features	61-773
1000A AC/DC Clamp Meter	61-775
660AAC Clamp Meter	61-763
660A AC/DC Clamp Meter	61-765

Includes: Carrying Case and Test Leads w/Crocodile Clips.



1000A Clamp (61-773)



660A Clamp (61-763)

Specifications	Range & Resolution				Accuracy
	61-773	61-775	61-763	61-765	
AC Current	0.0-999.9A		0.0-660.0A		2.0%
DC Current	—	0.0-999.9A	—	0.0-660.0A	2.0%
AC Voltage	0.0-750.0V				1.0%
DC Voltage	0.0-999.9V				1.0%
Resistance	0.0-999.9Ω				1.5%
Capacitance	0.0-999.9μF				5.0%
Continuity	0.0-999.9Ω				Audible @ <30Ω
Frequency	20.0-400.0Hz				0.5%
Jaw Size	2" (51mm)		1.42" (36mm)		—

Test Leads



Description	Cat. No.
Test Leads with crocodile clips	TL-770

Clamp Meters

Clamp-Pro™ Clamp Meters 600 Amp (740 Series)

- Measures up to 600AAC
- Non-contact voltage indicator (70V-600VAC)
- Continuity
- Tapered jaws with hook tip
- Auto/manual ranging
- Data hold
- Auto power off
- Low battery indicator
- 2-year warranty

61-744



Description	Cat. No.
600A Clamp Meter w/ TRMS	61-746
600A Clamp Meter	61-744

Includes: Carrying Case and Test Leads.

Specifications Range & Resolution Accuracy

Specifications	Range & Resolution	Accuracy
		61-744 & 61-746
AC Current	40.00/400.0/600A	1.7%
AC Voltage	400.0/600 V	1.2%
DC Voltage	400.0/600 V	0.5%
Resistance	400.0/4.000k/ 40.00k 400.0k/4.000M/40.00M Ω	1.0%

Jaw opening is 1.25" (32mm).

Test-Pro® Multimeters (340 Series)

- Capacitance
- Frequency
- Temperature
- Voltage
- Current
- Resistance
- Audible continuity
- Relative mode
- Backlight
- Min/max
- Data hold
- Low battery indicator
- Auto power off
- 2-year warranty

61-342



Description	Cat. No.
Test-Pro® Multimeter w/TRMS	61-342
Test-Pro® Multimeter	61-340

Includes: Test Leads and Thermocouple.



Replacement Test Leads



Description	Cat. No.
Test Leads with crocodile clips	TL-770

Specifications Range & Resolution Accuracy

Specifications	Range & Resolution	Accuracy
		61-340 & 61-342
AC Voltage	4.000/40.00/400.0/600 V	1.5%
DC Voltage	400.0m/4.000/40.00/400.0/600 V	0.5%
Current	400.0µ/4000µ/40.00m/400.0m/4.000/10.00A AC/DC	1.5%
Resistance	400.0/4.000k/40.00k/400.0k/4.000M/40.00M Ω	1.0%
Capacitance	40.00n/400.0n/4.000µ/ 40.00µ/400.0µ F	3.0%
Frequency	10.000/100.00/1.000k/10.00k/100.0k/1.000M/4.000M Hz	0.3%
Temperature	-4° F to 1382° F (-20° C to 750° C)	3.0%

VoltAware™ Non-Contact Voltage Tester

- Indicates presence of voltage from 40-1000VAC
- Visual indication of voltage
- Selectable audible indication of voltage
- Sleek, compact design
- Green LED indicates power on
- Low battery indicator
- Battery replacement (AAA size)
- 2-year warranty

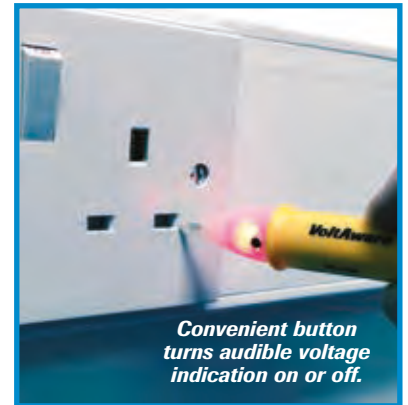
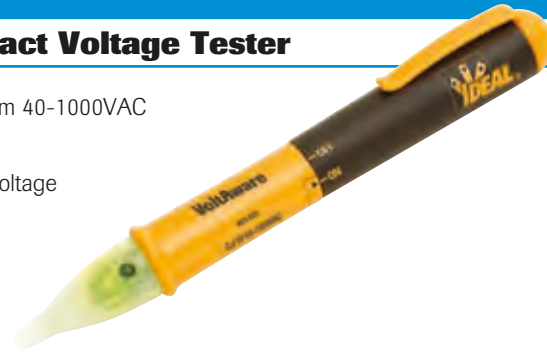

Convenient button turns audible voltage indication on or off.

Description	Cat. No.
VoltAware™ Non-Contact Voltage Tester	61-025EU



Digital Light Meter

- Auto or manual ranging
- Measures in four ranges up to 20,000 FC or 200,000 Lux
- +/- 3% basic accuracy
- Data hold mode
- Max. reading mode
- Auto zero adjustment
- Low battery indication
- Auto power off
- Remote sensor with 59 in. (1.5m) cable



Description	Cat. No.
Digital Light Meter	61-686

Includes: Carrying Case.



Vol-Con® Elite Digital Voltage Tester

- Tests for AC Voltage from 24-600VAC
- Tests for DC Voltage from 6-220VDC
- Visual and audible warning
- Audible continuity
- Non-contact voltage indication (40-600VAC)
- Low impedance to eliminate ghost voltages
- Low battery indicator
- Replaceable GS38 compliant test leads
- Integral lead storage
- 2-year warranty



Description	Cat. No.
Vol-Con® Elite Digital Voltage Tester	61-090EU

Accessories

Includes	
GS38 Compliant Test Leads	TL-102EU



SureTrace™ Circuit Tracers

- Receiver display rotates automatically for easy viewing
- Identifies breakers and fuses with CertainCircuit™ detection
- Pinpoints opens and shorts
- Traces wires behind walls
- “0-99” display of signal strength
- Audible intensifies in tone/pitch
- Works on energised or de-energised circuits (0 - 600V AC/DC)
- Four modes of sensitivity – search high, search low, trace and breaker
- Peak detecting bar graph
- 2-year warranty



Scan for product video

61-955



CertainCircuit™

After you identify and trip the correct breaker, the transmitter senses the loss of power and sends a different signal back to the receiver to give you confidence at the panel that the right circuit was de-energised.



Energised



De-energised



The only circuit tracer with SwivelDisplay™

Circuit Tracers

Transmitter will work on a de-energised circuit and won't affect RCD's and sensitive equipment on an energised circuit.



Transmitter and receiver take four standard AA batteries.

RC-959 Receiver



RC-955 Receiver



TR-955 Transmitter



NEW
Enhanced
Performance



Inductive Clamp & Battery Pack



Exclusive Rotating Display

Revolutionary technology in the receiver rotates the display in 90° increments so that you always receive an upright reading. Even when the receiver is pointing down, you can keep up.



CR-959



Circuit Tracers

Description	Cat. No.
Kit Includes: Rotating Display, Inductive Clamp and Battery Pack	61-959
Kit Includes: Rotating Display	61-957
Kit Includes: Standard Display	61-955

Accessories

Includes	
Fuse – High-energy, Fast-acting, 1A/1000V	F-956
Magnetic Strap	61-565
Replacement Lead Set UK (includes 1-6 below)	TL-958UK
Replacement Lead Set EU (includes 1-6 below)	TL-958EU
1. Outlet Plug Adaptor for Transmitter (UK or EU)	
2. Blade Prongs for Lead Adaptors (2/set)	
3. Ground Prong for Lead Adaptor	
4. Crocodile Clips for Lead Adaptors (2/set)	
5. 90 cm (3 ft.) Lead Adaptors for Transmitter (2/set)	
6. 7.5 m (25 ft.) Lead Adaptor for Transmitter	
Optional	
Cradle for Receiver*	CR-959

*Threaded for use on standard extension pole.

Kit Contents	61-955	61-957	61-959
Transmitter	TR-955	TR-955	TR-955
Receiver	RC-955	RC-959	RC-959
Tracer Test Lead Set	TL-956	TL-956	TL-956
Inductive Clamp			IC-958
Battery Pack			BP-958
Hard Carrying Case	C-955	C-957	C-959
Batteries	•	•	•
Instruction Manual	•	•	•

Digital Circuit Breaker Finder & Socket Tester

- Locates breakers and fuses quickly and accurately
- Check polarity and easily identifies common wiring faults
- Verifies presence of power
- Visual and audible indicators
- Non-contact voltage sensor for 80 - 300 VAC
- Optional 61-184EU probe kit for testing at light fixtures
- Comes with soft carrying case
- 2-year warranty



Description	Cat. No.
Digital Circuit Breaker Finder & Socket Tester (includes carrying case)	61-534EU
Crocodile Clip & Probe Set	61-184EU

Specifications

	61-534EU
Operating Voltage	200 - 250 VAC
Operating Frequency	47 - 63 Hz



61-534EU



61-184EU

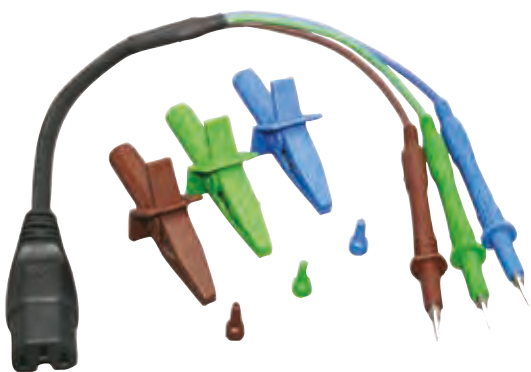

DATAKOM/NETWORKS



LanTEK® III Series Cable Certifier

Superior performance, revolutionary fibre options and outstanding value makes LanTEK® III the ultimate cable certification platform.

The LanTEK III is an easy to use cable certifier that meets existing TIA and ISO/IEC performance requirements for testing up to Cat. 7A/1000MHz.

Using the free IDEAL AnyWARE app, field technicians can share test data with colleagues or customers without leaving the jobsite, resulting in greater collaboration, more on-time job completions and reduced costs

- New troubleshooting features that save time and money – Locate hidden connections, splices and cable faults using Time Domain Return Loss (TDRL) and Time Domain Crosstalk (TDX).
- New permanent link adapter saves money – Reduce down time and lower maintenance costs with field replaceable RJ45 contacts.
- New FiberTEK III modules – Tier 1 certification of fibre cabling eliminates the need for additional fibre testers. Available on 500MHz and 1000MHz models (optional).
- Industry leading battery life – 18 hours of continuous testing without interruption.
- New test data software – Create powerful client reports quickly and easily from multiple testers using one PC application.
- Replaceable Cat 6A permanent link adapter tips – Reduces cost of ownership. Centred connectors provide minimal tolerance and are compatible with all RJ45 twisted pair cabling connectors (optional)



Scan for
more information



FIBERTEK® III

- FiberTEK III adapters are used with LanTEK III for fast and simple certification of high bandwidth single-mode and multimode fibre optic cabling including support for encircled flux testing (optional)
- Certification: Tier 1 certification of single-mode and multimode fibre optic cabling
- Troubleshooting: Red laser light source to visually pinpoint faults and locate fibre ports
- Encircled Flux compliance: Enables compliance to the new fibre standards IEC 14763-3 and ANSI/TIA 526-14-C (optional)
- Field calibration: Allows 1 and 3 jumper field calibration methods to ensure accuracy and compliance to IEC and ANSI/TIA standards
- Simplified bi-directional measurements: Eliminates process of manually merging directional tests into one record

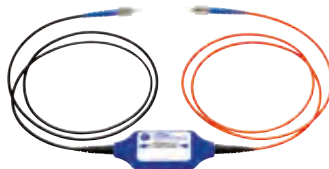

Description	Cat. No.	Description	Cat. No.
LanTEK III-500MHz – (test adapters to be ordered separately)	R161001*	FiberTEK III-MM LED Kit – Includes two multimode FiberTEK III modules	R164005**
LanTEK III-1000MHz – (test adapters to be ordered separately)	R161002*	FiberTEK III-SM Laser Kit – Includes two single-mode FiberTEK III modules	R164006**
LanTEK III-500MHz – (including PL adapters)	R161003**	FiberTEK III-MM LED & SM Laser Kit – Includes two multimode and single-mode FiberTEK III modules	R164007**
LanTEK III-1000MHz – (including PL adapters)	R161004**		
*Contents: LanTEK® III display and remote handset, Li-ion battery (2), universal power adapter (2), USB cable, headset (2), hanging strap (2), quick reference guide, carry case, USB Wi-Fi adapter (1). ** As under * but includes permanent link adapter - R161051 (2).			
**Contents: Lockable semi-rigid carrying case, SC, FC, ST adapters for modules (2 ea.), quick reference guide. (MM kit: SC-SC patch cords 6x 50µm MMF; SM kit: SC-SC patch cords 6x 9µm SMF, MM & SM Kit: SC-SC patch cords 6x 50µm MMF and SC-SC patch cords 6x 9µm SMF) compliant to ISO/IEC 14763-3 standard, quick reference guide, and electronic operation manual.			

SignalTEK™ CT Data Cable Transmission Tester

If you install or maintain data cabling, SignalTEK CT allows you to generate PDF test reports that prove installed links run at Gigabit Ethernet transmission rates.

For installers, this means having a cost-effective way to demonstrate that the copper cabling was installed correctly and is capable of supporting Ethernet applications. By proving real world performance, SignalTEK CT confirms a professional job - reducing the risk of call backs.

SignalTEK CT also gives network owners the assurance that installed cabling will support bandwidth hungry services like VoIP, IP CCTV and video streaming following moves, adds and changes



Testing as simple as 1-2-3



Step 1 Test

- 8 user defined fields available
- Up to 50 individual jobs
- Job information automatically included in the test report documentation
- Enter job site information
- Perform autotest on copper cabling



Step 2 Connect

- Activate SignalTEK CT wireless hotspot
- Connect your mobile phone or tablet with the IDEAL AnyWARE App
- Transfer test reports to your mobile device
- View test reports



Step 3 Send

- Select reports (pdf or csv) to send
- Select preferred transfer method – email, ftp, cloud storage etc.
- Send file
- Alternatively save test reports to USB key

Test Reporting

SignalTEK CT automatically generates test reports in PDF format.

The summary page of each report can be customised to include logo, company and operator details. The summary provides an overview for each link tested including date and time of test, the overall result of the wiremap and data tests, the Ethernet rates that the cable can support, and the individual and total cable lengths.

Detailed information relating to each tested link is reported on subsequent pages. This includes a graphical image of the wiremap, pass/fail information, length per pair, frame errors and data rate.



Scan for
more information

Description	Cat. No.
SignalTEK CT – Data Cable Transmission Tester. Includes 1 x display, 1 x remote, 2 x NiMH batteries, 2 x patch cables - 30cm, Cat 5e STP, 2 x power supply with EU/UK/US adapters, 1 x user manual 1 x carry case	R156004



Test Name	Date (mm/dd/yy)	Time (hh:mm)	Pairs Setup	Wiremap Test	Data Test	10Mb/s	100Mb/s	1Gb/s	Length (m)
0001	03/01/10	00:40	4	✓	✓	✓	✓	✓	17
0002	03/01/10	00:50	4	x	✓	✓	✓	✓	49

0001									
Wiremap Test: ✓									
Pair	1-2	3-6	4-5	7-8	1 2 3 4 5 6 7 8				
Length (m)	18	18	18	17	1 2 3 4 5 6 7 8				
Data Test: ✓									
Error Limit (Frames)	Duration (hh:mm:ss)	Rate (Mb/s)	Error (Frames)	1 2 3 4 5 6 7 8 9					
0	00:00:10	1000	0	1 2 3 4 5 6 7 8 9					

0002									
Wiremap Test: x									
Pair	1-2	3-6	4-5	7-8	1 2 3 4 5 6 7 8				
Length (m)	50	49	49	49	1 2 3 4 5 6 7 8				
Data Test: ✓									
Error Limit (Frames)	Duration (hh:mm:ss)	Rate (Mb/s)	Error (Frames)	1 2 3 4 5 6 7 8 9					
0	00:00:10	1000	0	1 2 3 4 5 6 7 8 9					

SignalTEK™ NT Network Transmission Tester

If you install, maintain or troubleshoot data cabling and Ethernet networks, SignalTEK NT allows you to prove the performance up to Gigabit Ethernet transmission rates. By simulating actual network traffic users are able to test and document network and data cable performance to Gigabit Ethernet standards.

Where system warranties are not required the SignalTEK NT is a cost effective way of proving your copper and fibre networks provide error-free performance. SignalTEK NT automatically generates test reports in PDF or CSV format.

Use the free IDEAL AnyWARE™ app from IDEAL Networks to view / send data cable and network test reports to colleagues and clients anywhere.



- Full Gigabit bi-directional load testing through hubs and switches
- Simulate network traffic generated by new IP devices to confirm network capacity before adding new devices like VOIP or CCTV
- Identify Ethernet, Power over Ethernet (PoE) and PoE+ issues, in addition to verifying Ethernet connectivity (including IPv4 and IPv6)
- Locate wiremap faults more quickly and accurately by testing every pin and pair, detecting split pairs and identifying the distance to fault
- Testing complies to the Gigabit Ethernet standard IEEE 802.3ab
- Identify network connection problems as hardware, network or configuration faults
- Ping local network devices and Internet URL's
- Port blink to visually trace cable from work area outlet to network switch
- Field replaceable RJ-45 contacts eliminate downtime from worn or damaged connectors

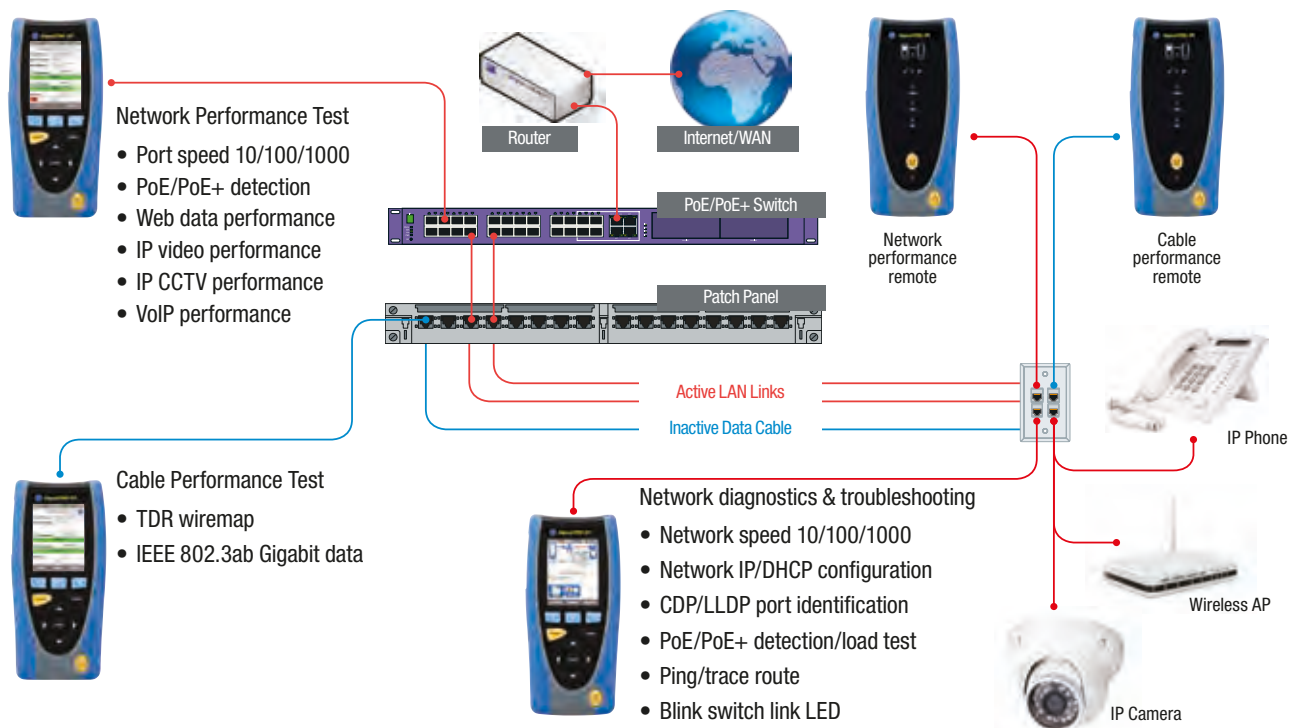

Network Testers

Description	Cat. No.
SignalTEK NT - Network Transmission Tester. Includes 1 x display, 1 x remote, 2 x NiMH batteries, 2 x patch cables - 30cm, Cat 5e STP, 2 x power supply with EU/UK/US adapters, 1 x USB Wi-Fi adapter, 1 x user manual, 1 x carry case	R156003



Scan for more information



NaviTEK NT Network Troubleshooter

The NaviTEK NT is a network tester for troubleshooting and maintenance of active and passive copper and fibre networks. Incorporating an improved graphical interface NaviTEK NT allows network technicians to pinpoint and solve network connectivity issues faster than ever before. Subsequently, tests can be saved as pdf reports and shared with colleagues and clients using the free IDEAL AnyWare™ app.

NaviTEK NT offers a comprehensive suite of test and troubleshooting functionality only found on dedicated hand-held testers:-

- Copper and fibre test interfaces
- Fast detection of link and IP information
- Detects services such as ISDN, POTS and PoE
- Accurate wire mapping including length measurement and distance to fault
- Rugged, compact design permits use in confined spaces
- Not susceptible to virus and malware attack



Port & network summary info



Press the Autotest button to display summary information

VLAN detection & operation

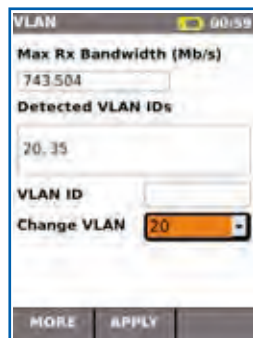

Automatic detection of VLAN ID's

Ethernet utilisation

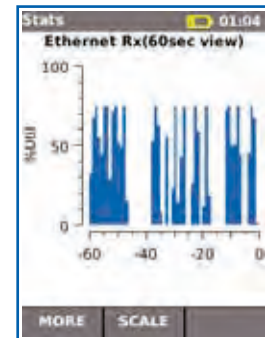

Real time display of broadcast network traffic

CDP/LLDP/EDP port information



Show port information using Discovery Protocols.

Netscan

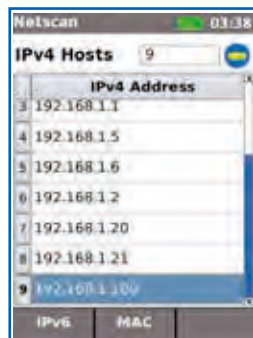

Display list of IP and MAC addresses of every device connected to the network.

Network Probe

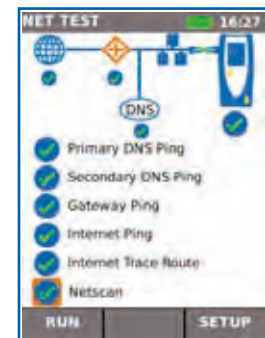

View network illustration to verify test results of each network component.

Description	Cat. No.
NaviTEK NT - 1 x NaviTEK NT test unit, 1 x Remote unit No. 1, 4 x AA dry cell batteries (non-rechargeable), 2 x Patch cables - 30cm, Cat. 5e STP, 1 x Quick reference guide, 1 x Carry case	R153001
NaviTEK NT PLUS - 1 x NaviTEK NT Plus test unit, 1 x Remote unit No. 1, 1 x Rechargeable Power Module, 1 x PSU EU/UK/US adapters, 2 x Patch cables - 30cm, Cat. 5e STP, 1 x USB Wi-Fi adapter, 1 x Quick reference guide, 1 x Carry case	R151003
NaviTEK NT PRO - 1 x NaviTEK NT Pro test unit, 1 x Remote unit No. 1, 1 x Rechargeable Power Module, 1 x PSU EU/UK/US adapters, 2 x Patch cables - 30cm, Cat. 5e STP, 1 x USB Wi-Fi adapter, 1 x Quick reference guide, 1 x Carry case	R151004



Scan for more information



VDV II - Voice, Data and Video Verifier

The new VDV II Series are easy to use cable testers that check the integrity of copper cables commonly found in domestic, commercial or industrial voice, data or video installations, including telephone wiring, data network and video/security cabling.

Employing state-of-the-art technology, VDV II offers functionality not previously available in a wiremapper. The advanced wiremap engine accurately displays complex wiring faults instantaneously whilst TDR (Time Domain Reflectometry) aids troubleshooting and improves on-site productivity.

More than just a wiremapper



VDV II

Performs standard tests for copper cabling, including:

- Coax, 6Pin (RJ11/12), 8Pin (RJ45) Connectors for Copper Cable Testing
- Wiremap for Miswires, Split Pairs, Shorts and Opens
- Analog Tone Generator
- Voltage Protection
- Shielded Cable Testing
- Single Screen Results



VDV II Plus

Additional features to the VDV II:

- Larger 2.9" Display
- Backlight
- Hub Blink
- Cable Length
- Distance to Open
- Carry Case & Cables



VDV II Pro

Additional features to the VDV II Plus:

- Distance to Open / Short (TDR)
- PoE Detection with Voltage Information
- Media Service Detection
- Ethernet Detection with Network Rate and Duplex Information

Applications



VOICE

Support for 1, 2 or 3-pair RJ11/12 telephone cable testing



DATA

Testing of shielded and unshielded Cat 5/5e/6/6A/7 LAN cable

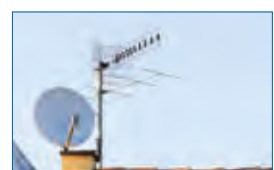

VIDEO

Tests coax cable through F-connector interface

Description	Cat. No.
VDV II – Voice, Data and Video Cable Verifier. Includes 1 x tester, 1 x dual port remote unit, 1 x coax remote unit, 1 x alkaline battery, 1 x multi-language user guide.	R158000
VDV II Plus – Voice, Data and Video Cable Verifier. Includes 1 x tester, 1 x dual port remote unit, 1 x coax remote unit, 1 x alkaline battery, 1 x multi-language user guide, 2 x RJ45 to alligator clip cable 390mm, 2 x screened RJ45 to RJ45 cable 150mm, 2 x RJ11/12 to RJ11/12 cable 100mm, 1 x F-type plug to F-type plug cable 230mm, 1 x F-81 barrel splice, 1 x BNC female to F-type male adapter, 1 x BNC female to F-type female adapter, 1 x RCA female to F-type male adapter, 1 x RCA female to F-type female adapter, 1 x wallet wiring card, 1 x carry case.	R158002
VDV II Pro – Voice, Data and Video Cable Verifier. Includes 1 x tester, 1 x dual port remote unit, 1 x coax remote unit, 1 x alkaline battery, 1 x multi-language user guide, 2 x RJ45 to alligator clip cable 90mm, 2 x screened RJ45 to RJ45 cable 150mm, 2 x RJ12 to RJ12 cable 100mm, 1 x F-type plug to F-type plug cable 230mm, 1 x F-81 barrel splice, 1 x BNC female to F-type male adapter, 1 x BNC female to F-type female adapter, 1 x RCA female to F-type male adapter, 1 x RCA female to F-type female adapter, 1 x wallet wiring card, 1 x carry case.	R158003



For accessories like RJ45 remote units, RJ45 identifiers and Coax remote units, please check out page E-7.

Scan for
more information



FiberMASTER™ Fibre Optic Testers

The IDEAL FiberMASTER™ allows the user to measure absolute power and calculate the insertion loss of fibre optic links at several wavelengths. Measure fibre optic power in microwatts (μ W), milliwatts (mW) and decibel-milliwatts (dBm) to test and troubleshoot active Local Area Networks. Plus the 1490nm wavelength measurement mode is perfect for troubleshooting emerging Fibre to the Home cabling systems.

- Tier 1 certification of multi-mode and single mode fibre optic cabling
- **Fibre Optic Power Meter & Light Source** – Four wavelength power meter for multimode and single mode testing, and 850nm multimode LED light source.
- **Calibration Function** – Stores reference power level for quick dB loss measurements eliminating the need to manually calculate loss.
- **Save Time and Money** – Power meter features 2.5mm universal and FC adapters, light source includes ST®, SC and FC adapters to test the most common interfaces.
- **Ready for FTTx** – 1490nm measurement wavelength for use with nearly all single mode Fibre-To-The-Home applications.
- **Designed for the Field** – Unique “docking” light source and easy three-button operation make this the perfect fibre tester for use in the field.

FiberMASTER™ 33-928 Kit Includes:

- 33-926 Light source, 850nm LED with ST®, SC and FC adapters
- 33-927 Power meter, 4 wavelength with universal 2.5mm and fixed FC adapter
- 2x SC-SC 50 μ m multimode cables
- 1 SC calibration coupler
- Carrying case
- User manual in English, Spanish, German, French, Portuguese, Italian and Chinese
- 33-931 kit is supplied with quad light source



Description	Cat. No.
Power meter with 850NM fibre light source (33-926 & 33-927)	33-928
Power meter with four wavelength MM/SM light source (33-927 & 33-929)	33-931



Visual Fault Finder

Laser light source used to locate breaks, faulty splices and crimps in fibre optic cabling

- 2.5mm Universal Adapter for all ST®, SC and FC connectors
- Useful over a distance of 5km (3 miles)
- Two AA batteries provide over 30 hours of continuous use
- Slim, pocket-sized tool in rugged solid aluminum body
- Nylon carrying case with belt loop included

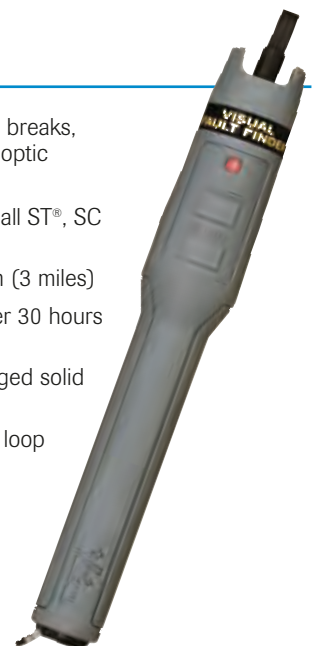

Description	Cat. No.
Visual Fault Finder	VFF5

Note: ST® is a registered trademark of AT&T.

SecuriTEST™ PRO

CCTV installers often need to carry a variety of testing tools to complete their work.

SecuriTEST™ PRO combines the most-needed tools in one easy-to-carry package. Since all connections (video/communications/DMM) attach to a single unit, **SecuriTEST™ PRO** eliminates the need to juggle several devices while on a ladder or lift, making working conditions safer and increasing productivity.

SecuriTEST™ PRO includes IRE testing (video and sync levels), audio level testing, a high-capacity lithiumion battery in a package that's small and light.

The **SecuriTEST™ PRO** has all the features and functionality that CCTV technicians need to install, test and maintain analogue security camera systems. **SecuriTEST™ PRO** also includes a custom carrying case.



Description	Cat. No.
SecuriTEST™ PRO CCTV/Security Tester only	33-892



Tone & Probe Kit



Amplifier Probe

- Identifies and traces wire or cables within a group
- Battery low indicator

Tone Generator

- Emits three different types of tones
- Auto-off after three hours of non-use
- F-Connector port for toning & tracing coaxial CATV cabling systems
- Tone can be added in any status



Description	Cat. No.
Tone Generator	62-160
Amplifier Probe	62-164
Tone & Probe Kit	33-864

Ratchet Telemaster™ RJ-11/RJ-45 Crimp Tool



- Pro quality ratcheting Telemaster™ Tool for RJ-45 and RJ-11 crimping modular plugs
- Gives repeatable crimp action for consistent, high quality connections
- For paired conductors
- Heavy-duty steel frame

Description	Cat. No.
Ratchet Telemaster™ RJ-11/RJ-45 Crimp Tool	30-696
Replacement Cut & Strip Blade Set for 30-696	LA-4102

LinkMaster™ Tester



Tests wiring configurations on UTP/STP cables. Checks for shorts, miswires, reversals and split pairs. Debug feature, automatic shut-off and low battery LED indication.

- Designed to test installed twisted pair wiring
- Tests unshielded and shielded modular plugs
- Main unit and remote allow one person testing

Description	Cat. No.
LinkMaster™ Tester and Remote	62-200



Telemaster™ RJ-11/RJ-45 Crimp Tool



- Multi-function tool cuts, strips and crimps for easy one-tool application
- For paired conductors
- Steel frame for long-term durability. (Crimps primary modular plug strain relief only)

Description	Cat. No.
Tool for RJ-11 (1, 2, 3 pair) and RJ-45 (4 pair) Plugs	30-496-001
Replacement Cut and Strip Blade Set for Telemaster™	LB-1747

*Kit includes 10 each, RJ-45 8P8C, RJ-11 6P6C and RJ-11 6P4C modular plugs.

Crimpmaster™ Crimp Tools & Die Sets

High quality ratchet-type crimp tool for electricians, contractors and installers who require guaranteed repeatability of good mechanical and electrical connections.

Dies change quickly and easily with a screwdriver. Interchangeable dies provide versatility in a single tool

30-506

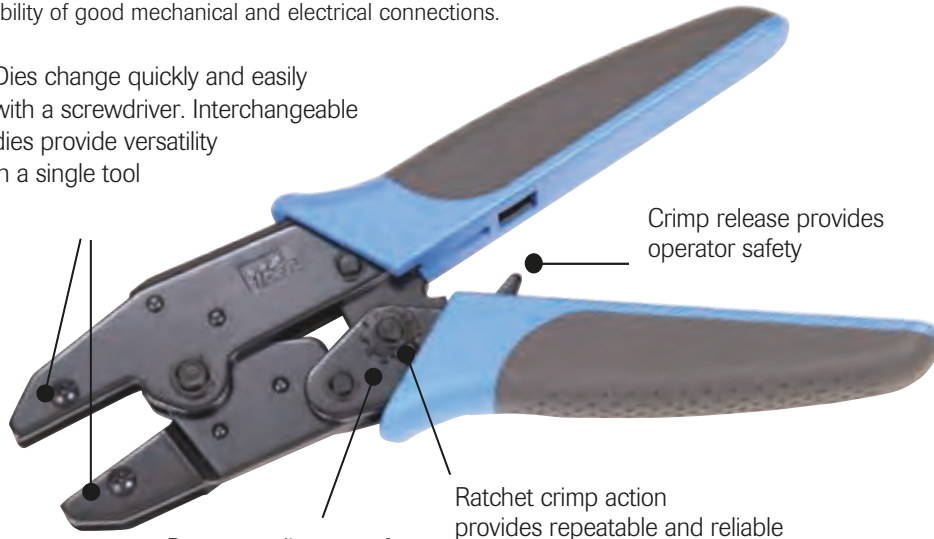

Crimp release provides operator safety

Pressure adjustment for actuation force

Ratchet crimp action provides repeatable and reliable terminations

30-559

RJ-45 Eight-position crimp die set for keyed or non-keyed modular plugs



30-582

Die set for F-type CATV RG-59, RG-6 Connectors (Hex, 0.350 (8.9mm), 0.320 (8.1mm), 0.255 6.5mm)



30-579

Die set for insulated terminals/colour coded nests 22-10 AWG (.3mm² - 5.3mm²)



30-580

Die set for non-insulated terminals 22-8 AWG (0.3mm²-8.0mm²)



30-581

Die set for RG-58, RG-59/62, BNC/TNC Coax Connectors (Hex, 0.255 (6.5mm), 0.213 (5.4mm), 0.068 (1.7mm))



Description	Cat. No.
Crimpmaster™ Crimp Frame Tool	30-506
Die set for RJ-45 eight-position keyed or non-keyed modular plugs	30-559
Die set for insulated terminals/colour coded nests	30-579
Die set for non-insulated terminals	30-580
Die set for RG-58, RG-59/62, BNC/TNC Coax Connectors	30-581
Die set for F-type CATV RG-59, RG-6 Connectors	30-582

PunchMaster™ Punch Down Tool

- Inserts and cuts cable terminations effortlessly
- Professional quality tool
- For seating telecom and data cables into terminals effortlessly
- Adjustable high/low actuation setting accommodates termination requirements
- Turn-Lock™ Style blade holding design
- Impact-absorbing cushioned grip reduces operator stress for high volume installers

35-485

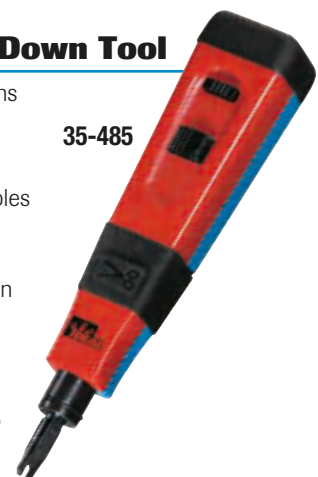

Punch Down Tool



- Insertion tool for Krone blocks
- For seating telecom and data cables into terminals



35-478

Description	Cat. No.
Punch Down Tool (Insertion tool for Krone blocks)	35-482

Description	Cat. No.
Punchmaster™ II Punch Down Tool w/110 & 66 blades	35-485
Removable Krone® Blade for 35-485	35-478

Krone® is a registered trademark of Krone, Inc.

OmniSeal™ PRO Compression Tool

The IDEAL OmniSeal™ PRO Compression Tool offers additional features and increased connector compatibility in a smaller, more compact tool designed to meet the demands of the professional installer.



Most other manufacturers compression connectors can be terminated with an easy plunger depth adjustment. The simple intuitive design combined with its size and universal connector acceptance makes this the only compression tool needed by professional installers.

- Factory preset to work with IDEAL compression connectors
- Compresses F-type, RCA, BNC and Mini connectors
- Adjustable to fit other manufacturer's connectors – no accessory adapters required

Description	Cat. No.
OmniSeal™ PRO XL Compression Tool	30-793



LinearX® Compression Tool Features

- Available in fixed and adjustable versions
- Compresses F/BNC/RCA connectors

A hinged hasp keeps the tool in a compact closed position when not in use

Handle has double dipped textured cushion grip for comfort and all-day use

One handed operation is possible with all compatible connectors.



LinearX3 adjustable post

Durable and rugged zinc die-cast body with a protective powder coated paint finish



Compression Tools

- Available in fixed and adjustable versions
- Compresses F/BNC/RCA connectors
- Durable & rugged zinc die-cast body with protective powder coated paint finish
- Linear stroke for consistent compression results & easy operation
- Includes four RTQ™ RG-6 WeatherProof F-Compression Connectors

LinearX™3 adjustable post



INCLUDES 4 RTQ™ F-Connectors



Description	Cat. No.
LinearX®3 F/BNC/RCA Compression Tool (Adjustable) with four RTQ™ F-Connectors	33-632

Connector & Tool Compatibility Chart

Type	IDEAL Connector	OmniSeal™ Pro XL 30-793	LinearX®3 33-632
F	F 6 RTQ™	✓	✓
	F 6Q RTQ™	✓	✓
	F 6 RTQ™ 90°	✓	✓
	F 59 RTQ™	✓	✓
	F 6 NJX™	✓	✓
	F 6Q NJX™	✓	✓
BNC	BNC 59	✓	✓
	BNC 59 90°	✓	✓
	BNC 6 RTQ™	✓	✓
RCA	RCA 6	✓	✓

✓ No tool adjustment needed. ✓ Tool adjustment needed. — Not compatible.



Hip Kit - 33-622

- Cut, strip and terminate F connectors in one handy starter tool kit

- Kit Includes:

LinearX®1 F-Compression Tool (Fixed)

45-074 Data T®-Cutter

45-605 PrePRO® Cable Stripper

Pouch with clip



Compression Connectors



RTQ™ Reg/Tri/Quad F-Connectors

- Fits 60% regular, tri-shield and quad shield cables
- Nickel-plated, brass-construction for superior corrosion resistance
- Designed for use in satellite and cable TV installations
- WeatherProof™ for indoor and outdoor use
- Use 30-793 or LinearX Compression Tools
- New INSITE™ 90° RG-6 F-Connector version available



INSITE™ BNC Connectors

- Clear 360° window for confident cable insertions
- Nickel-plated, brass-construction for superior corrosion resistance
- Moisture-inhibiting design
- Use 30-793, 30-603 or 33-632 Compression Tool
- 75 Ohm nominal impedance
- Gold-plated pin contact area
- Available in plenum versions



NJX™ F-Connectors

- 75 ohm nominal impedance
- Bandwidth up to 3 GHz
- Compatible with all IDEAL Compression Tools
- Compact body size
- RG-6 and RG-6 Quad versions

Compression Connectors



TLC™ F-Connectors

- No compression tool required
- 75 ohm nominal impedance
- Bandwidth up to 3 GHz
- Compact body size
- RG-6 version

NJX™ F-Compression Connectors

The new NJX™ (pronounced “injects”) compression connector offers a high performing, reliable and economical solution designed for applications that do not require weatherproof connectivity. NJX™ is also great for installers looking to upgrade from traditional hex crimp or twist-on coax F termination methods.

Available in F-Type interfaces for RG-6 and RG-6 Quad cables, the NJX™ connectors are an indoor cable specific alternate to the OmniConn™ series of products. NJX™ connectors require the same 6.5 mm x 6.5 mm (1/4" x 1/4") cable preparation and compression termination as all other IDEAL compression connectors.

Colour coded, injection moulded bodies make these connectors lighter, more compact, and more cost effective for installers. Unlike traditional compression connectors that get shorter when compressed, the NJX™ series connectors have a post-forward design, which during compression, is “injected” into the body of the connector. Although these connectors are shorter, they still utilise the same compression settings and stroke length as all IDEAL F-compression connectors. Once compressed, the cable is secured creating a permanent 360° compression ring on the cable. NJX™ connectors are designed for applications from 5MHz to 3GHz including CATV and satellite.

For outdoor/weatherproof or universal cable compression products, the RTQ™ series of compression products are recommended.



NJX™ RG-6

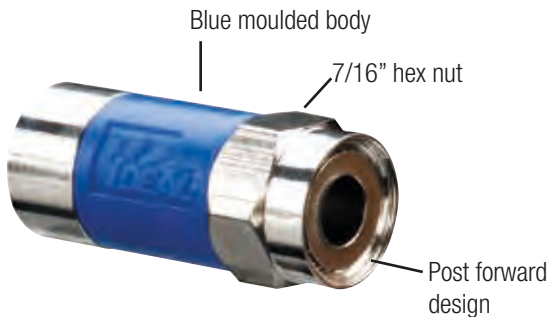

NJX™ RG-6 Quad

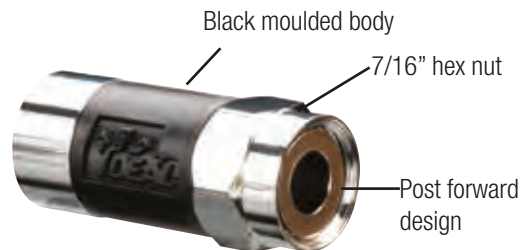

TLC™ Tool-Less Compression Connectors



TLC™ RG-6

The new TLC™ (Tool-Less Compression) RG-6 F compression connector is our simplest, fastest and lowest total cost solution for installing compression connectors. Designed to save the installer **Time, Labour and Cost** when installing indoor RG-6 F-Type connections **no compression tool is required** to terminate these connectors.

The TLC™ connector is an indoor, cable specific alternate to the NJX™ series of products.

The TLC™ connector uses the standard 6.5 mm x 6.5 mm (1/4" x 1/4") cable preparation, that does not require a compression tool to complete the termination process. TLC™ series connectors feature a sliding post design to capture and secure the cable inside of the connector. After the cable is inserted, tightening the connector to the device completes assembly process, creating a 360° compression point and a permanent connection.

IDEAL F/BNC insertion tools (35-046, 35-042, 35-043) can be used (but are not required) when installing the TLC™ cable assembly to ensure connectors are properly torqued and fully seated to the female barrel. These connectors are designed for applications from 5MHz to 3GHz including CATV and satellite.

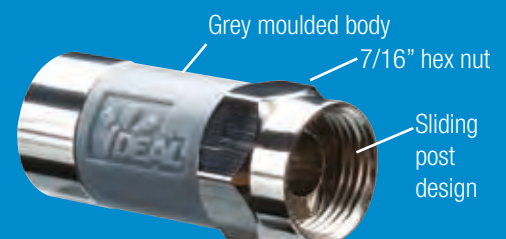

Compression Connectors

Model	Type	Model	Cable Type	Qty.	Cat. No.
	F	RTQ™	RG-59 / Reg/Tri/Quad	Card of 10 Jar of 50	92-611 92-610
	F	RTQ™	PF100/CT100/RG-6/ Reg/Tri/Quad	Card of 10 Jar of 50	92-651 92-650
	F	TLC™	RG-6	Card of 10 Card of 50	85-068 85-168
	F	NJX™	RG-6	Card of 10	89-040
	F	NJX™	RG-6 Quad	Card of 10	89-041
	F	InSITE™ RTQ™ 90°	RG-6	Card of 5	92-691
	BNC	InSITE™ 90°	RG-59	Card of 5	92-693
	BNC	InSITE™ RTQ™	RG-6	Card of 15	89-048
	BNC	InSITE™	RG-59	Card of 15	89-047

1GHz Cable Splitters

- Nickel-plated housing, soldered back
- High-performance impedance - balanced Printed Circuit Board design
- Bandwidth: 5MHz - 1 GHz Impedance: 75 Ω; Splits signals up to 8 outlets



Description	Cat. No.
High Performance Cable Splitter, 5MHz-1GHz, 2-Way	85-132
High Performance Cable Splitter, 5MHz-1GHz, 4-Way	85-134

All IDEAL compression connectors require a standard 6.5 mm x 6.5 mm (1/4" X 1/4") cable preparation. This preparation leaves 6.5 mm (1/4") of the centre conductor exposed and an additional 6.5 mm (1/4") of the shielding exposed. Prep tools are available in single, two or three blade models. Two blade models are the most commonly used type of stripping tool for coax compression as they remove both 6.5 mm (1/4") sections at one time during the prep. Single blade models require two separate stripping actions for compression preparation. IDEAL has several models of cable preparation tools that are compatible with compression connectors, each having various feature choices such as user adjustable blade depths, replaceable blades, number of active blades, product size and hand motion required to prep the cable.

Compression Cable Prep Instructions



Start with a clean piece/fresh cut of coax.



Prep/strip cable to size.



Fold back braiding. Leave inner foil intact.



Check for flush dielectric and no visible wrapped braiding strands.



Fully compress the connector with appropriate tool.



Connect to device. Use the F/BNC insertion tool if needed to reach proper tightening torque.

FT-45™ Modular Plug Crimp Tool



The FT-45™ is a simple, compact and highly effective crimp tool for installers and technicians that terminate RJ45 connectors regularly.

- Quality - Cleanly shears the excess conductors and leaves a smooth, flat finish
- Versatile - Suitable with Feed-Thru, standard, or shielded connectors (CAT5e or CAT6)
- Heavy duty - Cutting blade that will last for over 2,000 cuts
- Ergonomic - Reduced hand force compared to traditional crimp tools
- Compact - Easily fits in your pocket and lightens the tool bag load
- Easy to use - 568A & 568B wiring scheme marked on the tool
- Easily maintained - Replaceable cutting blades available
- Patented design - Patent pending design requires less than 1/2 of the mechanical force to crimp connectors. No ratchet needed.
- A patent pending design enables conductors to be cut flush with the end face of the connector when used with the FT-45™ tool

Description	Cat. No.
FT-45™ Feed-Thru Modular Plug Crimp Tool	30-495
FT-45™ Replacement Blade	30-4951

CAT5e/6 Feed-Thru RJ-45 Modular Plugs



Open-end Feed-Thru connectors offer several advantages over standard closed end connectors.

- Reduces errors - Wires can be easily verified before trimming.
- Easy to use - Conductors do not need to be pre-trimmed to a specific length
- Improved wire stability - 3 prong contacts into every wire for more conductive contact points

Description	Qty.	Cat. No.
CAT5e Feed-Thru RJ-45 Modular Plugs	25	85-370
CAT5e Feed-Thru RJ-45 Modular Plugs	50	85-371
CAT5e Feed-Thru RJ-45 Modular Plugs	100	85-372
CAT6 Feed-Thru RJ-45 Modular Plugs	25	85-375
CAT6 Feed-Thru RJ-45 Modular Plugs	50	85-376
CAT6 Feed-Thru RJ-45 Modular Plugs	100	85-377

Modular Plugs

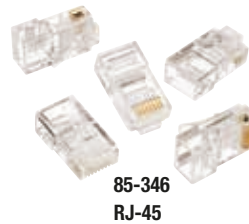

**85-346
RJ-45**



**85-344
RJ-11**

- Plugs are capable of supporting the latest EIA/TIA cable system performance categories when installed in compliance with appropriate EIA/TIA standards and methods
- All plugs work with 24 AWG solid or stranded conductors and round or flat cables.

Description	Qty.	Cat. No.
8-Position 8-Contact, RJ-45	25	85-346
6-Position 6-Contact, RJ-11	25	85-345
6-Position 4-Contact, RJ-11	25	85-344

CAT 6 RJ-45 Modular Plugs



- Unique three-piece design provides easy installation and optimal performance
- Crimps with a standard RJ-45 crimp die
- 50 micron gold contacts, 8-position, 8-contact
- Suitable for solid or stranded conductors - 22 - 23 AWG

Description	Qty.	Cat. No.
CAT 6 RJ-45 Modular Plugs	25	85-366

Strain Relief Boots for Modular Plugs

- Prevents broken connector tabs and snagging while extending connector life
- Minimises cable bends that can reduce data speed and result in data loss
- Dampens cable movement and vibrations that can result in premature connector failure



Description	Qty.	Cat. No.
Strain Relief Boots for Modular Plugs	25	85-380

UTP/STP/Coaxial Cable Strippers

- Adjustable blades can be set for any depth to help ensure nick-free stripping and slitting of cables

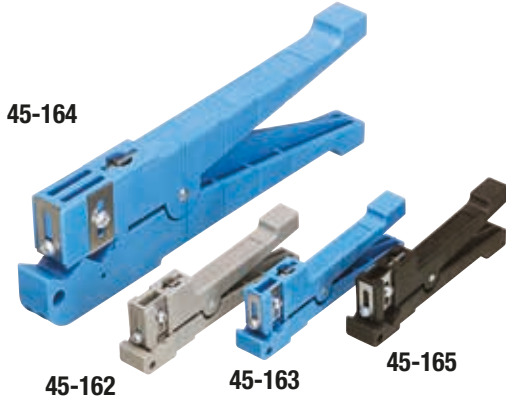

Description	Typical RG Cables	Cat. No.
Coaxial Cable Stripper, up to 1/8 in. (3.2mm) O.D	RG-174, RG-187	45-162 (Grey)
Coaxial Cable Stripper, 1/8 in. (3.2mm) to 7/32 in. (5.56mm) O.D.	Mini Coax RG-58,CB	45-163 (Blue)
Coaxial Cable Stripper, 1/4 in. (6.4mm) to 9/16 in. (14.3mm) O.D.	RG-11, RG-8	45-164 (Blue)
Cable Stripper, 3/16 in. (4.8mm) to 5/16 in. (8mm) O.D.	RG-59/6, UTP Cable	45-165 (Black)
Replacement Blade Set* for 45-162, 45-163, 45-165	—	L-9225
Replacement Blade Set* for 45-164	—	L-9226

*A set of blades consists of three straight blades and one round blade.

Coax Stripper

- Specific adjustments needed for each cable size
- For crimp BNC and TNC connectors
- Strips braid 0.240 in. or 6mm and dielectric 0.240 in. or 6mm



Description	Cat. No.
Coax Stripper - 3 Step <ul style="list-style-type: none"> For crimp BNC and TNC connectors Strips braid 0.240 in. or 6mm and dielectric 0.240 in. or 6mm 	45-520

Kinetic Super™ Wire Stripper/Crimper



- Cuts and strips 22 to 24 AWG
- Crimps IDC Connectors

Description	Cat. No.
Kinetic Super™ Wire Stripper/Crimper Kit – includes 25 IDC's (UR-1, 3-Wire Butt Splice)	33-719

Insulation Displacement Connectors (IDC)



85-900

85-925

85-950

IDC connectors create fast splice and tap connections on solid copper wires. Designed for low voltage telecommunication cables.

- Moisture-resistant sealant protects wires from corrosion
- Use with solid copper single-conductor wire
- Kinetic Super™ Wire Stripper/Crimper easily cuts and strips 22 to 24 AWG solid wire

Description	Qty.	Cat. No.
UR-1, 3-Wire Butt Splice IDC	25	85-925
UR-1, 3-Wire Butt Splice IDC	100	86-925
IDC Combo Pack	25	85-960
UY-1, 2-Wire Butt Splice IDC	25	85-950
UB-1, 2-Wire Tap Splice IDC	25	85-900

PrepPRO™ Coax/UTP Cable Stripper

- Auto adjusting blade depth for 6/6Quad/59 coax cable
- 1/4" x 1/4" coax preparation
- Replaceable blade cartridges
- CAT5e/6 jacket stripping
- Spring loaded for consistent cutting force



Description	Cat. No.
PrepPRO™ Coax/UTP Cable Stripper	45-605

Data T[®]-Cutter



- Cuts round communication cable and maintains cable geometry for better cable performance
- Cuts multi-pair cable up to .500 in. (12.7mm) and coaxial cable up to RG-9/U
- Suitable for soft cables (not steel reinforced)
- Steel reinforced centre conductors can be trimmed with bolt cutting holes
- Locking latch keeps tool closed in pouch

Description	Cat. No.
Data T [®] -Cutter	45-074

Good Round dielectric

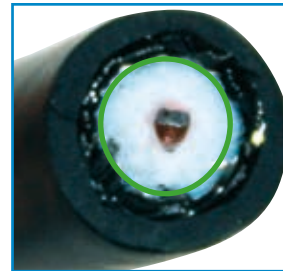

Bad Oval dielectric



Network Tester Accessories

Description	Cat. No.
SignalTEK NT / NaviTEK NT remote kit #2-#12	150050
SignalTEK NT / NaviTEK NT remote #1	150054
SignalTEK NT / NaviTEK NT Cat 5e STP patch cables (2)	150055
SignalTEK NT / NaviTEK NT duplex multi-mode patch cable	150056
SignalTEK NT / NaviTEK NT duplex single mode patch cable	150057
SignalTEK NT / NaviTEK NT RJ-45 insertion/removal tool and 10 RJ-45 inserts	150058
SignalTEK NT / NaviTEK NT active remote kit #2 - #6	150059
SignalTEK NT / NaviTEK NT power supply with EU/UK/US adapters	151051
SignalTEK NT / NaviTEK NT alkaline battery module	151052
SignalTEK NT NIMH power module	151053
NaviTEK NT carrying case	151054
SignalTEK NT carrying case	156050
VDV II RJ-45 remote kit #1 - #12	158050
VDV II RJ-45 identifier kit #1 - #24	158051
VDV II coax remote kit #1 - #12	158053
SignalTEK NT / NaviTEK NT 1310nm single mode SFP module	MGKLX2
SignalTEK NT / NaviTEK NT 850nm multi-mode SFP module	MGKSX1
SignalTEK NT / NaviTEK NT 1550nm single mode SFP module	MGKZX3



158050

158051



150050

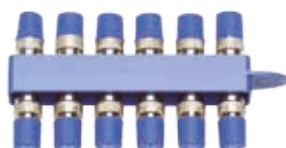

158053

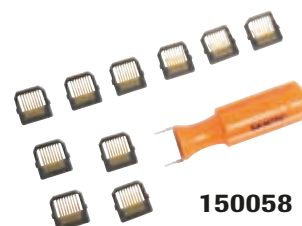

150058

Item	Page
1GHz Cable splitters.....	E-14
7-in1 Stripper	B-7
A	
Accessories for networks testers.....	E-17
Adjustable Cable Lockout..	C-5
Amplifier Probe.....	E-9
Anti-Oxidant, Noalox®.....	B-5
Aqua-Gel® II Cable Pulling Lubricant	B-4
Auto-Lock™ Tape	Measure..... B-14
B	
Bag, Large Mouth	B-14
BenderBoot™	B-6
Benders, Conduit	B-6
Blued-Steel™ Fish Tapes	B-2, B-3
C	
Cable Certifier, LanTEK® III.....	E-2
Cable Cutter PowerBlade™	B-10
Cable Cutter, Ratcheting	B-11
Cable Cutters	B-9
Cable Lockout, Adjustable .	C-5
Cable Splitters.....	E-14
Cable Stripper, Twin & Earth	B-8
CAT 5e/6 Feed-Thru RJ-45 Modular Plugs.....	E-15
CAT 6 RJ-45 Modular Plugs.....	E-15
CCTV/Satellite Coax Stripper.....	E-16
CCTV/Security Tester, SecuriTEST PRO.....	E-7
Certifier, Cable, LanTEK® III	E-2
Circuit Breaker Finder.....	D-8
Circuit Breaker Lockouts...	C-5
Circuit Tracers, SureTrace™	D-6, D-7
Clamp Meter Selection Guide	D-2
Clamp Meters, Clamp-Pro™	D-4
Clamp Meters, TightSight®	D-3
Clamp-Pro™ Clamp Meters	D-4
ClearGlide™ Wire Pulling Lubricant	B-4
Coax Cable F-Terminators	E-13
Coax Strippers.....	E-16
Compression Connectors	E12-E14
Compression Tools.....	E-11
Conduit Benders.....	B-6
Connectors, Insulation	

Item	Page
Displacement	E-16
Contractor Lockout/ Tagout Kit	C-2, C-3
Contractor Pro Lockout/ Tagout Kit	C-2, C-3
Crimp Tool, Crimpmaster™	E-10
Crimp Tool, FT-45™ Modular Plug.....	E-15
Crimp Tool, Ratchet.....	B-14
Crimper/Stripper, Kinetic Super™	E-16
Crimpmaster™ Crimp Tool	E-10
Cutter, Cable Ratcheting	B-11
Cutter, Data	B-9, E-16
Cutter, Long-Arm	B-9
Cutter, PowerBlade™	B-10
D	
Data & Video, Voice Verifier	E-6
Data Cable Transmission Tester, SignalTEK CT	E-3
Data T®-Cutter	B-9, E-17
Digital Circuit Breaker Finder	D-8
Digital Light Meter.....	D-5
Digital Voltage Tester, Vol-Con® Elite	D-5
Displacement Connectors, Insulation	E-16
Domestic Installer Lockout/ Tagout Kit	C-2, C-3
Duct Seal.....	B-5
E	
Electrical Plug Lockouts ...	C-6
F	
Feed-Thru RJ-45 Modular Plugs, Cat 5e/6	E-15
FiberMASTER™ Fibre Optic Testers	E-7
FIBERTEK III Modules	E-2
Fibre Optic Testers.....	E-7
Fish-Tapes.....	B-2, B-3
FT-45™ Modular Plug Crimp Tool.....	E-15
F-Terminators, Coax Cable	E-13
Fuse Puller, Safe-T-Grip®	B-14
H	
Hacksaw, Heavy-Duty	B-14
Handles for Benders	B-6
Hasp, Universal.....	C-4
I	
In-Line Wire Connectors,	

Item	Page
SpliceLine®	A-4
InSITE™ Compression Connectors	E12-E14
Installer, Domestic, Lockout/ Tagout Kit	C-2, C-3
Insulated T®-Stripper Wire Stripper, Premium.....	B-8
Insulation Displacement Connectors	E-16
In-Sure® Lever Wire Connectors	A-3
In-Sure® Push-In Wire Connectors	A-2
K	
Kinetic Super™ Wire Stripper/Crimper.....	E-16
L	
LanTEK® III Series Cable Certifier.....	E-2
Leads, Test.....	D-3, D4
Lever Wire Connectors, In-Sure™	A-3
Light Meter, Digital	D-5
Lil' Ripper Stripper	B-7
LinearX® Hip Kit	E-11
LinearX® Compression Tool.....	E-11
LinkMaster™ Tester	E-9
Lock Stations.....	C-6
Lockout Device, Tie-Bar ...	C-5
Lockout Devices, MCB ...	C-5
Lockout Devices, Universal MCB	C-5
Lockout Hasps, Steel, ...	C-4
Lockout Tags.....	C-6
Lockout/Tagout Kits... C-2, C-3	
Lockouts, Circuit Breaker ..	C-5
Lockouts, Electrical Plug... C-6	
Logout Hasp, Non-Conductive	C-4
Long-Arm Cable Cutter....	B-9
Lubricants, Wire Pulling ...	B-4
M	
Marking Pen	C-6
MCB Lockout Devices.....	C-5
Mini-MCB Lockout Device. C-4	
Modular Plug Crimp Tool, FT-45™	E-15
Modular Plugs.....	E-15
Modules, Fibre	E-2
Multimeter Selection Guide	D-2
Multimeters, Test-Pro®....	D-4

Item	Page
N	
NaviteK NT Network Troubleshooter	E-5
Network tester accessories	E-17
Network Transmission Tester, SignalTEK NT.....	E-4
Network Troubleshooter, NaviTEK NT.....	E-5
NJX™ Compression Connectors	E-12-E14
Noalox® Anti-Oxidant.....	B-5
No-Hole Lockout Devices..	C-5
Non-Conductive Logout Hasp	C-4
Non-Conductive Safety Padlocks.....	C-4
Non-Contact Voltage Tester, VoltAware™	D-5
O	
OmniSeal™ PRO Compression Tools.....	E-11
Optical, Fibre Testers.....	E-7
P	
Padlocks, Safety	C-4
Pen, Marking.....	C-6
Personal Lockout/ Tagout Kit	C-2, C-3
Plug Lockouts, Electrical... C-6	
Plugs, RJ-45 Modular, Cat 5e/6 Feed-Thru	E-15
Pouch	C-6
PowerBlade™ Cable Cutter	B-10
Premium Insulated T®-Stripper Wire Stripper.....	B-8
PrepPRO™ Coax/UTP Cable Stripper.....	E-16
Puller, Fuse, Safe-T-Grip®	B-14
Punch Down Tools.....	E-10
Push-In Wire Connectors, In-Sure™	A-2
Q	
Quick Change Screwdriver	B-13
R	
Ratchet Crimp Tool	B-14
Ratchet Telemaster™	E-9
Ratcheting Cable Cutter	B-11
Reflex™ Premium T®-Stripper Wire Strippers.....	B-7
RTQ™ Compression Connectors	E12-E14

<u>Item</u>	<u>Page</u>	<u>Item</u>	<u>Page</u>
S			
Safe-T-Grip®		Tools, Punch Down	E-10
Fuse Puller	B-14	Transmission Tester,	
Safety Padlocks	C-4	Data Cable, SignalTEK CT . .	E-3
Satellite/CCTV		Transmission Tester,	
Coax Stripper	E-16	Network, SignalTEK NT	E-4
Screwdriver, Quick		Twin & Earth Cable Stripper	B-8
Change	B-13	Twister® Wire Connectors .	A-5
SecuriTEST PRO		U	
CCTV/Security Tester	E-8	Universal Hasp	C-4
Selection Guide,		Universal MCB Lockout	
Clamp Meter	D-2	Devices	C-5
Selection Guide, Multimeter	D-2	UPT/STP/Coaxial Cable	
SignalTEK CT Data Cable		Strippers	E-16
Transmission Tester	E-3	V	
SignalTEK NT Network		VDV II, Voice, Data &	
Transmission Tester	E-4	Video Verifier	E-6
Socket Tester	D-8	Video, Voice & Data Verifier	E-6
SpliceLine® In-Line Wire		Visual Fault Finder	E-7
Connectors	A-4	Voice, Data & Video Verifier	E-6
Splitters, Cable	E-14	Vol-Con® Elite Digital	
Stations, Lock	C-6	Voltage Tester	D-5
Steel Lockout Hasps	C-4	Voltage Tester, Digital	D-5
STP/UTP Coaxial Cable		Voltage Tester, Non-Contact	D-5
Strippers	E-16	VoltAware™ Non-Contact	
Strain Relief Boots	E-15	Voltage Tester	D-5
Stripmaster® Wire Stripper	B-8	Volt-Guard Fish Tapes .	B-2, B-3
Strippers, Coax	E-16	W	
Strippers, T®-Stripper Wire	B-7	WeatherProof Wire	
SureTrace™ Circuit		Connectors	A-5
Tracers	D-6, D-7	Wire Connector Kits	A-6
T			
T®-Cutter Data	B-9, E-16	Wire Connectors,	
T®-Stripper Wire Strippers.	B-7	In-Sure™ Lever	A-3
Tagout, Lockout Kits . .	C-2, C-3	Wire Connectors, In-Sure™	
Tags, Lockout	C-6	Push-In	A-2
Tape Measure,		Wire Connectors,	
Auto-Lock™	B-14	SpliceLine® In-Line	A-4
Telemaster™ RJ11/RJ-45		Wire Connectors, Twister®.	A-5
Crimp Tool	E-10	Wire Connectors,	
Telemaster™, Ratchet	E-9	WeatherProof®	A-5
Test Leads	D-3	Wire Crimper/Stripper,	
Tester, LinkMaster™	E-9	Kinetic Super™	E-16
Tester, Socket	D-8	Wire Cutter, T®-Cutter	B-9
Testers, Data Cable		Wire Pulling Lubricants	B-4
Transmission, SignalTEK CT	E-3	Wire Stripper, Stripmaster®	B-8
Testers, Network		Wire Stripper/Crimper,	
Transmission, SignalTEK NT	E-4	Kinetic Super™	E-16
Test-Pro® Multimeters	D-4	Y	
Tie-Bar Lockout Device	C-5	Yellow 77® Wire Pulling	
TightSight® Clamp Meters.	D-3	Lubricant	B-4
TLC™ Compression		Z	
Connectors	E12-E14	Zoom™ Fish Tapes	B-2, B-3
Tone & Probe Kit	E-9		
Tone Generator	E-9		

Item	Page	Item	Page	Item	Page	Item	Page	
441.001	C-5	30-506	E-10	44-2393	C-5	74-		
441.002	C-5	30-559	E-10	44-2394	C-5		74-002	B-6
441.003	C-5	30-579	E-10	44-428EU	C-4		74-003	B-6
441.004	C-5	30-580	E-10	44-5833EU	C-6		74-019	B-6
15...		30-581	E-10	44-778-SO	C-6	74-020	B-6	
150050	E-17	30-582	E-10	44-806-SO	C-6	74-027	B-6	
150054	E-17	30-696	E-9	44-808	C-5	74-028	B-6	
150055	E-17	30-793	E-11	44-833EU	C-2			
150056	E-17	31-		44-924	C-3	83-		
150057	E-17	31-055	B-3	44-925	C-3		83-001	B-14
150058	E-17	31-056	B-3	44-985UK	C-3	85-		
150059	E-17	31-057	B-3	44-995	C-3		85-068	E-14
151051	E-17	31-090	B-3	45-		85-132	E-14	
151052	E-17	31-092	B-3	45-025	B-7	85-134	E-14	
151053	E-17	31-351	B-4	45-074	B-9, E-17	85-168	E-14	
151054	E-17	31-355	B-4	45-120-341	B-7	85-344	E-15	
156050	E-17	31-358	B-4	45-123	B-9	85-345	E-15	
158050	E-17	31-378	B-4	45-125-341	B-7	85-346	E-15	
158051	E-17	31-388	B-4	45-162	E-16	85-366	E-15	
158053	E-17	31-542	B-3	45-163	E-16	85-370	E-15	
		31-544	B-3	45-164	E-16	85-371	E-15	
		31-601	B-5	45-165	E-16	85-372	E-15	
		31-605	B-5	45-235	B-8	85-375	E-15	
		33-		45-292-341	B-8	85-376	E-15	
		33-622	E-11	45-425-341	B-7	85-377	E-15	
		33-632	E-11	45-520	E-16	85-380	E-15	
		33-719	E-16	E-16		85-900	E-16	
		33-864	E-9	45-777	B-7	85-925	E-16	
		33-892	E-7	45-9120-341	B-8	85-950	E-16	
		33-928	E-7	61-		85-960	E-16	
		33-931	E-7	61-025EU	D-5	86-		
		34-		61-090EU	D-5		86-925	E-16
		34-002	B-14	61-184EU	D-8	89-		
		35-		61-340	D-4		89-040	E-14
		35-033	B-9	61-342	D-4	89-041	E-14	
		35-053	B-12	61-534EU	D-8	89-047	E-14	
		35-078	B-10	61-686	D-5	89-048	E-14	
		35-242M	B-14	61-744	D-4	92-		
		35-260	B-14	61-746	D-4		92-610	E-14
		35-410	B-14	61-763	D-3	92-611	E-14	
		35-478	E-10	61-765	D-3	92-650	E-14	
		35-482	E-10	61-773	D-3	92-651	E-14	
		35-485	E-10	61-775	D-3	92-691	E-14	
		35-933	B-13	61-955	D-6, D-7	92-693	E-14	
		35-934	B-13	61-957	D-6, D-7	B		
		44-		61-959	D-6, D-7		BP-958	D-7
		44-0487	C-6	62-				
		44-0488	C-6	62-160	E-9			
				62-164	E-9			
				62-200	E-9			

<u>Item</u>	<u>Page</u>	<u>Item</u>	<u>Page</u>
C		R164005.....	E-2
CR-959.....	D-7	R164006.....	E-2
H		R164007.....	E-2
H-4076.....	B-6	RC-955.....	D-7
I		RC-959.....	D-7
IA-2280.....	C-5	T	
IA-3240.....	C-6	TL-100.....	D-4
IA-5502.....	C-4	TL-102EU.....	D-5
IC-958.....	D-7	TL-104.....	D-3
K		TL-956.....	D-7
K-40611.....	C-4	TR-955.....	D-7
K-40612.....	C-4	V	
K-41021.....	C-4	VFF5.....	E-7
K-7566.....	C-6		
K-8330.....	C-4		
K-8334.....	C-4		
K-8336.....	C-4		
KB-0224.....	C-4		
KB-0226.....	C-5		
KB-0227.....	C-5		
KB-0231.....	C-4		
KB-0234.....	C-5		
KB-0375.....	C-5		
KB-1234.....	C-4		
L			
L-9225.....	E-16		
L-9226.....	E-16		
LA-2182.....	C-5		
LA-4102.....	E-9		
LB-1747.....	E-9		
M			
MGKLX2.....	E-17		
MGKSX1.....	E-17		
MGKZX3.....	E-17		
R			
R151003.....	E-5		
R151004.....	E-5		
R153001.....	E-5		
R156003.....	E-4		
R156004.....	E-3		
R158000.....	E-6		
R158002.....	E-6		
R158003.....	E-6		
R161001.....	E-2		
R161002.....	E-2		
R161003.....	E-2		
R161004.....	E-2		

Merchandising

Point-of-purchase communication is an important aspect of IDEAL sales strategy. We are committed to helping our distributors move our products off their shelves. To do that, we've developed a variety of exciting, useful ways to increase a store's association with IDEAL and to build repeat customers.



Counter Top Displays



WIRE CONNECTOR DISPLAYS

IDEAL offers a range of merchandising solutions to display pre-defined or custom profiles of push-in, lever wire, SpliceLine and twist-on wire connectors. Options include floor standing and more compact counter/shelf display units, each designed to create high impact and drive impulse sales.

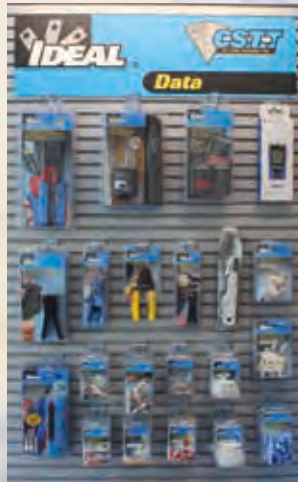

DATACOM PROFILE

IDEAL offers a complete solution for the network / data installer. Our range includes tools, connectors and network testers - cut, strip, terminate and test coaxial and twisted pair cables. Each profile is supported by POS materials including header boards and posters to create displays within displays.



LOCKOUT KITS

Lockout kits are merchandised using this high impact backing board. Designed to display the most popular lockout kits, this backing board fits on any configuration of slat wall. It also drives additional sales of lockout/tagout products such as safety padlocks and spare MCB lockout devices.



POSTERS

Using posters is an effective way to create more interesting and eye catching displays. IDEAL offers a range of posters designed to support products on display and generate product awareness and incremental sales on non-stocked products.



1M DISPLAY STAND

A 1m metal slat wall display stand is available to support the merchandising and sales of IDEAL products. These illuminated stands are perfect for displaying a range of core IDEAL profiles such as lockout kits, DataCom, wire connectors and cable installation products.