



RP







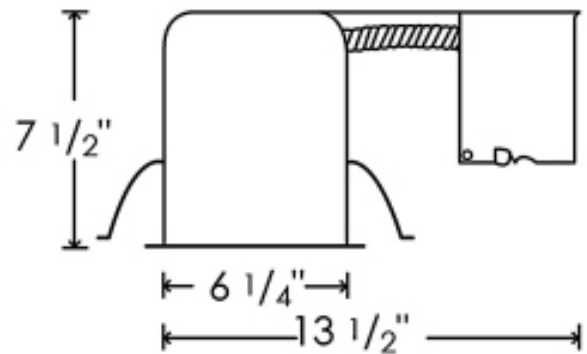









LIGHTING • FANS







Type:
Project:
Comments:
Prepared By:

<b>Part #</b>	<b>8102HRA</b>
Category #:	8102
Family:	Recessed
Product Category:	Recessed Down Light
Description:	6" Airtight Incandescent Recessed remodel w/ socket bracket
<b>Design Features</b>	
Connectors	3 part quick connectors pre installed in all J Boxes
Construction	Remodel
Thermal Protection	Protected against misuse of insulation and improper wiring
IC Rating	IC rated for direct contact with non cellulose type insulation
J Box	Listed for feed through wiring (4 in-4 out) and eight 1/2" knockouts & 3 non metallic cable knockouts w/ strain clamps
Wattage	Up to 75W
Voltage	120V-60Hz
<b>Warranty</b>	<b>1 year limited warranty</b>
Lamp	A19, PAR30/38, BR30/38, LED retro
<b>Listing</b>	
ETL/UL	cULus certified for damp location & feed through wiring.
Meets Washington's State energy code for restricted airflow	



# Trim Options

	Type	Item#	Finishes	O.D.
	Open Trim 150W Max, PAR38/BR40	8501	White	8"
	Shower, Lexan, Fresnel Lens 40W Max, A19	8502FS- BR	Wet location listed Socket Bracket Included Metal trim ring available	8"
	Black Baffle 150W Max, PAR38/BR40	8503	Black Optional BA, BK, rings	8"
	Black Baffle 75W Max PAR30/BR30	8504	Black Optional Brushed Aluminum and black rings	8"
	Lexan Flat Opal Albalite Lens 60W Max, A19	8505AL	White	8"
	Eyeball 75W Max, PAR30/BR30	8506	White and Black	8"
	Open Trim 75W Max, PAR30/BR30	8508	Brushed aluminum and	8"
	Lexan Drop Opal 60W Max, A19	8509DR- BR	Wet location listed Socket Bracket Included Metal trim ring available	8"
	White Baffle 150W Max, PAR38/BR40	8510	White Optional BA, BK, OB rings	8"
	White Baffle 75W Max, PAR30/BR30	8511	White Optional BA, BK, OB rings	8"
	Specular Reflector 75W Max, PAR30/BR30	8513	Finishes: Clear Black and White	8"
	Reflector 150W Max, PAR38/BR40	8515	Clear and Brushed Aluminum Optional BA, BK rings	8"
	Regressed Eyeball, w/ Baffle 75W Max PAR30/BR30	8516	White	8"
	Wall Wash 60W Max, A19	8517WW	White	8"
	Reflector 100W Max, A19	8518	Brushed aluminum, clear and white Optional BA, BK, PB rings	8"
	Cone, Baffle 100W Max PAR30/BR30/A19 PAR38/BR40	8519	Black and white	8"

	Fresnel Lens w/Baffle 40W Max, A19	8522	White	8"
	Wall Wash 60W Max, A19	8527	CL w/Clear Reflector WH w/White Baffle	8"
	Baffle, w/Clear Reflector 75W Max PAR30/BR30	8534	White	8"
	Reflector 75W Max PAR30/BR30	8535	Clear	8"
	Shower Trim w/Regressed Drop Opal Lens 40W Max, A19	8537	Wet location listed White	8"
	Gimbal 75W Max, PAR30	8540	Black, white and oil rubbed bronze	8"
	Splay 40W Max, A19	8546	White	8"

## Additional Information

---

1. Socket is adjustable for proper positioning of different lamps types.
2. Adjusts to fit up to 1-1/4" ceiling thickness.
3. 7-1/2" height allows use in 2" x 8" joist construction.



RP







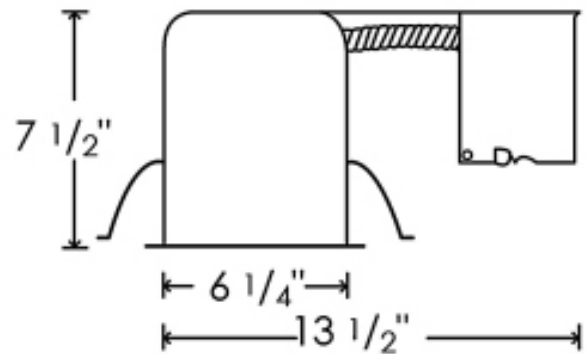







LIGHTING • FANS







Type:
Project:
Comments:
Prepared By:

<b>Part #</b>	<b>8102HRA</b>
Category #:	8102
Family:	Recessed
Product Category:	Recessed Down Light
Description:	6" Airtight Incandescent Recessed remodel w/ socket bracket
<b>Design Features</b>	
Connectors	3 part quick connectors pre installed in all J Boxes
Construction	Remodel
Thermal Protection	Protected against misuse of insulation and improper wiring
IC Rating	IC rated for direct contact with non cellulose type insulation
J Box	Listed for feed through wiring (4 in-4 out) and eight 1/2" knockouts & 3 non metallic cable knockouts w/ strain clamps
Wattage	Up to 75W
Voltage	120V-60Hz
<b>Warranty</b>	<b>1 year limited warranty</b>
Lamp	A19, PAR30/38, BR30/38, LED retro
<b>Listing</b>	
ETL/UL	cULus certified for damp location & feed through wiring.
Meets Washington's State energy code for restricted airflow	



# Trim Options

	Type	Item#	Finishes	O.D.
	Open Trim 150W Max, PAR38/BR40	8501	White	8"
	Shower, Lexan, Fresnel Lens 40W Max, A19	8502FS- BR	Wet location listed Socket Bracket Included Metal trim ring available	8"
	Black Baffle 150W Max, PAR38/BR40	8503	Black Optional BA, BK, rings	8"
	Black Baffle 75W Max PAR30/BR30	8504	Black Optional Brushed Aluminum and black rings	8"
	Lexan Flat Opal Albalite Lens 60W Max, A19	8505AL	White	8"
	Eyeball 75W Max, PAR30/BR30	8506	White and Black	8"
	Open Trim 75W Max, PAR30/BR30	8508	Brushed aluminum and	8"
	Lexan Drop Opal 60W Max, A19	8509DR- BR	Wet location listed Socket Bracket Included Metal trim ring available	8"
	White Baffle 150W Max, PAR38/BR40	8510	White Optional BA, BK, OB rings	8"
	White Baffle 75W Max, PAR30/BR30	8511	White Optional BA, BK, OB rings	8"
	Specular Reflector 75W Max, PAR30/BR30	8513	Finishes: Clear Black and White	8"
	Reflector 150W Max, PAR38/BR40	8515	Clear and Brushed Aluminum Optional BA, BK rings	8"
	Regressed Eyeball, w/ Baffle 75W Max PAR30/BR30	8516	White	8"
	Wall Wash 60W Max, A19	8517WW	White	8"
	Reflector 100W Max, A19	8518	Brushed aluminum, clear and white Optional BA, BK, PB rings	8"
	Cone, Baffle 100W Max PAR30/BR30/A19 PAR38/BR40	8519	Black and white	8"

	Fresnel Lens w/Baffle 40W Max, A19	8522	White	8"
	Wall Wash 60W Max, A19	8527	CL w/Clear Reflector WH w/White Baffle	8"
	Baffle, w/Clear Reflector 75W Max PAR30/BR30	8534	White	8"
	Reflector 75W Max PAR30/BR30	8535	Clear	8"
	Shower Trim w/Regressed Drop Opal Lens 40W Max, A19	8537	Wet location listed White	8"
	Gimbal 75W Max, PAR30	8540	Black, white and oil rubbed bronze	8"
	Splay 40W Max, A19	8546	White	8"

## Additional Information

---

1. Socket is adjustable for proper positioning of different lamps types.
2. Adjusts to fit up to 1-1/4" ceiling thickness.
3. 7-1/2" height allows use in 2" x 8" joist construction.