



METACAULK PRODUCT CATALOG



- Firestopping Sealants
- Firestopping Sprays
- Joint & Wrap Strip
- Firestop Devices
- Electrical Outlets
- Large Openings
- Smoke Sealants
- Mounting Equipment

Advanced product development

Combustion control room



Product Innovation

Our family of UL approved **Metacaulk®** Firestopping products is specifically designed to fill voids in construction joints and around penetrations in fire-rated walls or floors. Many have intumescent properties and expand when exposed to heat, forming a high-strength insulating char.

On-site test furnaces



Technological Development

In 1995, an on-site fire test laboratory was built for the purpose of conducting UL witnessed burns for through-penetration and construction joint assemblies. Our laboratory has been designated by UL under their Witness Test Data Program for fire testing to UL 1479 & UL 2079.

Hose stream test



Testing & Approvals

Our on-site fire test laboratory monitors all phases of test burns as specified by ASTM E-814 (UL 1479) or ASTM E-1966 (UL 2079). We have over 1200 Tested UL systems. Having an on-site UL lab speeds the development of new firestop products & UL systems, allowing quicker response to customer needs.



Support, training & service

Intumescent properties



Quality Assurance

You can depend on RectorSeal's expertise & over 75 years of manufacturing experience. Our Quality Assurance Team covers each and every aspect of the manufacturing process: from the initial inspection of raw materials, to on-site monitoring throughout production and onto the rigorous final inspection.

Quality control



Technical Service

You can depend on our knowledgeable Technical Service team to share their expertise on any of our over 350 products. We are dedicated to providing comprehensive product support to all of our customers from Architects, Engineers, Local Inspectors to contractors and the general consumer.

Hands-on training and seminars



Training Seminars

RectorSeal offers hands-on training to properly install a variety of **Metacaulk®** Firestop Products in approved systems. Participants receive instruction on solutions to firestopping needs. Students are introduced to new products and watch live fire demonstrations of our products in tested assemblies.

Contractor grade - Code compliant



Table of Contents

Firestop Sealants

Metacaulk® 1000
 Metacaulk® MC 150+
 FlameSafe® 900+
 Metacaulk® 350i
 Metacaulk® 835+
 Metacaulk® 950
pages 6 - 8



Firestop Sprays

Metacaulk® 1200
 Cable Coating
pages 9



Track-Safe™

page 10

Joint & Wrap Strip

Joint Strip
 Wrap Strip
 Metacaulk® Intumescent Sleeves
page 11



Firestop Devices

Metacaulk® Pass-Thru
 Metacaulk® Pipe Collars
page 12

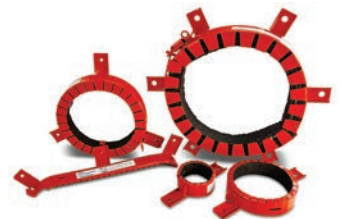

Scan for additional
 product information.



Firestopping products & solutions



Electrical Outlet Firestop

Cover Guard™
Box Guard™
Putty Sticks & Pads
page 13



For Large Openings

Firestop Pillows and Bags
Fire-Rated Mortar
Composite Sheet
page 14



Smoke Sealants

Smoke & Acoustic Sealant
RectorSeal® RS 136
Draft-Block™
page 15



Accessories

Caulking Guns
Safing
Restraining Collars
Wire Mesh
Foam Baker Rod
Deck Plugs
page 16

Cable Protection

page 17

Related Products

page 18

Mounting Equipment

page 19

metacaulk® **RECTORSEAL**

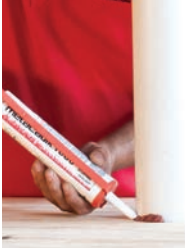

METACAULK® FIRESTOP SEALANTS

Metacaulk® 1000

Intumescent, water-based firestop sealant

Code	Description	Qty.
66640	10.3 oz. cartridge	12
66312	20.2 oz. foil pack	12
66303	30 oz. cartridge	12
66305	1 gal.	4
66307	2 gal.	1
66309	5 gal.	1



FEATURES

- UL Classified systems up to 4 hrs.
- Highly intumescent
- VOC compliant
- Excellent freeze-thaw
- For interior use - paintable
- Meets ASTM E 814, UL 1479 & UL 2079 standards
- STC rating 62

Application • Will prevent the spread of fire through joint openings and through-penetrations
 • No dilution or mixing required • Can be used in areas with some movement • Use in fire-rated gypsum wallboard partitions, concrete walls or floors, wood floors and concrete or corrugated steel deck floor/ceiling assemblies

Recommended for • Metal • Insulated pipes
 • Fiberglass & plastic pipes • Wall construction joints • Power, telephone & DataComm cables



See ordering chart for container sizes available.

*FBC™ "System Compatible" indicates that this product has been tested, and is monitored on an ongoing basis, to assure its chemical compatibility with FlowGuard Gold®, BlazeMaster® and Corzan® pipe and fittings.

**FBC™, FlowGuard Gold®, BlazeMaster® and Corzan® are licensed trademarks of the Lubrizol Corporation.

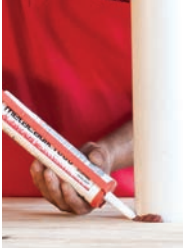

METACALK® FIRESTOP SEALANTS

Metacaulk® MC 150+

General purpose firestop sealant

Code	Description	Qty.
66648	10.3 oz. cartridge	12
66385	20.2 oz. foil pack	12
66383	30 oz. cartridge	12
66389	5 gal.	1



FEATURES

- Water-based - VOC compliant
- Good freeze-thaw
- For interior use - paintable
- Use for most common applications
- STC rating 51

Application • One component, general purpose fire-rated sealant and smoke seal for construction joints and through-penetrations on both horizontal and vertical surfaces

- Non-sag caulking grade sealant that is easy to apply as well as to retrofit
- Can be used in areas with some movement

Recommended for

- Metal
- Insulated pipes
- Fiberglass and plastic pipes
- Wall construction joints
- Power, telephone & DataComm cables



FlameSafe® 900+

Water Based Elastomeric Firestop

Code	Description (Red)	Qty.
66831	10.3 oz. Cartridge	12
66832	20.2 oz. Foil pack	12
66834	31 oz. Cartridge	6
66835	5 gal. Caulkable pail	1

Code	Description (Gray)	Qty.
66855	5 gal. Caulkable pail	1



FEATURES

- Versatile and economical
- Non-sag or Self-leveling grades
- Excellent adhesion
- Allows dynamic movement
- Flexible set
- Easy clean up
- No VOCs, non-toxic
- Low odor / Paintable
- Interior grade
- STC rating 62
- Up to 4 hour fire rating

Application • FS 900+ cures to form a flexible shield. In the event of a fire it will prevent the spread of flames and smoke through construction joint openings in fire-rated assemblies or for joints between fire-rated assemblies.

Recommended for

- Metal, insulated, fiberglass, and plastic pipes, cable and HVAC penetrations
- Concrete floor-to-floor, floor-to-wall and wall-to-wall
- Concrete • CMU and gypsum head of wall applications requiring dynamic movement.

Apply with • Caulking gun • Bulk loading gun • Trowel • Pumping equipment • No mixing required



*FBC™ System Compatible™ indicates that this product has been tested, and is monitored on an ongoing basis, to assure its chemical compatibility with FlowGuard Gold®, BlazeMaster® and Corzan® pipe and fittings.

**FBC™, FlowGuard Gold®, BlazeMaster® and Corzan® are licensed trademarks of the Lubrizol Corporation.

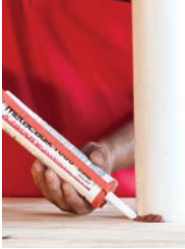

METACAUWK® FIRESTOP SEALANTS cont.

Metacaulk® 350i

Intumescent firestop sealant

Code	Description	Qty.
66616	10.3 oz. cartridge	12
66611	20.2 oz. foil pack	12
66613	5 gal.	1



FEATURES

- Highly intumescent
- Excellent freeze-thaw
- STC rating 53

Application • One component, general purpose sealant and smoke seal
 • Intumescent, water-based, non-sag caulking grade sealant that is easy to apply and great for retrofits • Can be used in areas with some movement

Recommended for

- Metal • Insulated pipes
- Fiberglass & plastic pipes
- Wall construction joints
- Power, telephone & DataComm cables



Metacaulk® 835+

Elastomeric, Silicone firestop sealant

Code	Description	Qty.
66645	10.15 oz. cartridge	12
66019	5 gal.	1
66300	20.2 oz. Caulk Grade foil pack	12
66301	20.2 oz. Self Leveling foil pack	12



FEATURES

- Exterior / Interior use
- Water resistant
- STC rating 55

Application • Used in systems where dynamic movement is expected
 • Resistant to water & chemical exposure

Recommended for • EMT • Insulated and uninsulated steel pipe
 • Construction and control joints • Expansion joints



Also available in 5 gal. pail.

Metacaulk® 950

Interior, water-based sealant

Code	Description	Qty.
66643	10.3 oz. cartridge	12



FEATURES

- Interior use
- VOC compliant
- Forms a hard char
- Non-combustible

Application • Formulated with inorganic materials which will not create smoke or toxic gases when exposed to fire • For interior applications only • Resistant to chemical exposure • Not for use in vibration or wet environments

Recommended for • PVC & CPVC pipe on closed (pressure) systems
 • EMT • Steel • Copper • Aluminum



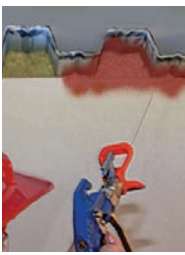

METACALK® FIRESTOP SPRAYS

Metacaulk® 1200

Spray & caulk firestop mastic



Code	Description - (Red)	Qty.
66379	5 gal. spray	1
66292	20.2 oz. foil pk	12
66015	30 oz. cartridge	12
66387	5 gal. caulk grade	1
66529	5 gal spray (USA)	1
66521	1 qt. self leveling	12
66523	5 gal. self leveling	1
Code	Description (White)	Qty.
66527	5 gal. spray	1
66525	30 oz. cartridge	12
66526	5 gal. spray (USA)	1
66386	5 gal. caulk grade	1

Application • Excellent fire-rated sealant, cures to an elastomeric seal suitable for dynamic movement
 • Available in 3 consistencies: spray allows fast, economical installation on long joint runs, self leveling is made for horizontal application and caulk grade is a non-sag sealant

Recommended for • Construction joints such as: top of the wall, curtain wall perimeter, expansion, control and etc. • Cable trays



FEATURES

- UL Classified systems up to 4 hrs.
- Sprayable, brushable & trowelable
- Flexible - elastomeric
- Allows dynamic movement
- Excellent smoke seal
- Good freeze-thaw
- VOC compliant
- STC rating 65

Sprayable 5 gal. pail
 also available - red & white.



Cable Coating

Industrial strength coating for power cables

Code	Description	Qty.
50250	5 gal.	1



FEATURES

- No cable derating
- Exterior / Interior use

Application • Water-based heavy duty spray coating designed to prevent vertical and horizontal spread of fire along grouped or single communication or power cables • Compatible with and adheres to typical cable jacketing materials





JOINT/WRAP STRIP & FIRESTOP DEVICES

Track-Safe™

Fire resistive head of wall joints

Code	Description	Qty.
66940	5/8" x 1 1/2" x 10'	20



FEATURES

- Up to 2 hours F rating
- Dynamic movement
- 100% unencumbered joint extension
- One sided installation
- L-Rating <1 CFM
- STC rating 57

Application • Installed on dynamic and static head of wall & bottom of wall joints where deep leg track and steel studs are used • 100% Compression & extension capabilities as well as drift movement with zero fatigue of joint and firestop material on deep leg track in steel stud wall assemblies





JOINT/WRAP STRIP & FIRESTOP DEVICES

Joint Strip

Flexible material for up to 2" wide joints

Code	Description	Qty.
66700	1" x 82' strip	6
66701	1-1/2" x 82' strip	4
66704	2" x 82' strip	3
66702	2-1/2" x 82' strip	2
66703	3" x 82' strip	2
66705	4" x 82' strip w/ adhesive	2



FEATURES

- No firestop caulk required
- Single sided application
- Simple & easy to use

Application • Flexible strip firestop material used in concrete and masonry floor and wall joints up to 2" wide • Prevents the passage of fire between joints • Plastic pipe penetrations

Recommended for • Stadium construction, tilt up panels • Curtain wall panels • Steel utility boxes • All concrete and masonry wall and floor construction joint applications • Can be used with any UL Listed sealant • Penetrations in walls & floors



US Patent No. 6,207,085

Wrap Strip

For penetrations

Code	Description	Qty.
66135	1" x 1/4" x 12'	6
66136	2" x 1/4" x 12'	4



FEATURES

- No cure time
- Easy to apply
- Long length means less waste
- Systems up to 14" PVC
- Highly intumescent

Application • Simply wrap required number of strips around penetrating item as required by system design

• When exposed to heat, expands to form a strong char to seal off the penetration

Recommended for • Plastic and insulated pipe applications



US Patent No. 6,207,085

*FBC™ System Compatible™ indicates that this product has been tested, and is monitored on an ongoing basis, to assure its chemical compatibility with FlowGuard Gold®, BlazeMaster® and Corzan® pipe and fittings. **FBC™, FlowGuard Gold®, BlazeMaster® and Corzan® are licensed trademarks of the Lubrizol Corporation.

Metacaulk® Intumescent Sleeve

Firestop Device

Code	Description	Qty.
66584	For 2", 3" & 4" Pipe	6
66582	For 6" & 8" Pipe	1



FEATURES

- No steel bolts or fasteners
- Can be retrofitted
- Flexible

Application • Firestop through penetrations with a single sleeve • Ideal for combustible pipes penetrating a concrete fluted deck assembly

Recommended for • PVC • cc-PVC • CPVC • FRPP • PP • ABS • Rigid non-metallic conduit installations

US Patent No. 6,207,085



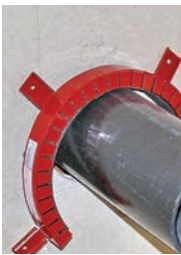

JOINT/WRAP STRIP & FIRESTOP DEVICES

Metacaulk® Pass-Thru

Code	Description	Qty.
66770	2-½" square	6
66773	4" square	6
66776	2" round	6
66779	4" round	6
66740	2-½" single sq. bracket	6
66743	2-½" double sq. bracket	3
66746	2-½" triple sq. bracket	2
66749	2-½" sixplex sq. bracket	1
66752	4" single sq. bracket	6
66755	4" double sq. bracket	3
66758	4" triple sq. bracket	2
66761	4" sixplex sq. bracket	1
66764	2" round bracket	6
66767	4" round bracket	6



FEATURES

- Easy to install & change cables
- Great for retrofit
- Highly intumescent
- Industry leading "L" rating

Engineered Firestop Sleeve

Application • Seals cables or pipes that penetrate thru 1 & 2 hour fire rated walls & floors • Square or round shaped steel sleeves with intumescent material • Opens for easy installation, retrofit or removal of cables

Recommended for • Electrical • DataComm • Communication cables • Pipes



US Patent No. 6,207,085

Foam insert replacements available

Metacaulk® Pipe Collars

Code	Description	Qty.
66352	1-½"	12
66353	2"	12
66350	3"	6
66351	4"	6
66354	6"	2



FEATURES

- No measurements of material
- Fits in limited access areas
- 25% reduction of installation time

Prefabricated firestop system

Application • UL classified for both open and closed pipe systems • Simple locking mechanism for easy installation

Recommended for • PVC • CPVC • ABS

- PVC foam core • ABS foam core
- FRPP • PEX pipe • Electrical cable
- Contact Tech Services for other options

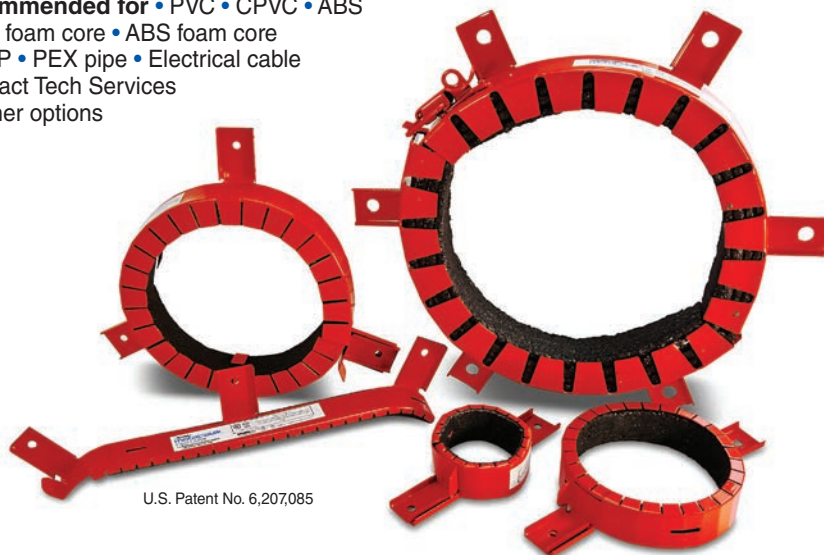

U.S. Patent No. 6,207,085



ELECTRICAL OUTLET FIRESTOP

Cover Guard™

Fire-rated gasket for electrical boxes

Code	Description	Qty.
66272	Single receptacle	50
66270	Double receptacle	50
66276	Single switch	50
66274	Double switch	50
66265	Single decor	50
66266	Double decor	50



FEATURES

- Reduces sound transmission
- Easy to install
- Highly intumescent
- STC rating 54

Application • A single component fire-rated gasket for use with electrical boxes to re-establish fire-rating of assemblies with electrical box penetrations

- Fits under the cover plate and does not take up interior box volume



US Patent No. 6,207,085; 6,252,167 & 7,348,484

Box Guard™

Fire-rated insert for electrical boxes

Code	Description	Qty.
66366	Single box	50
66367	Double box	50
66369	4- ¹¹ / ₁₆ " x 4- ¹¹ / ₁₆ "	50



FEATURES

- Adheres to back of electrical box
- Non-conductive
- Highly intumescent
- STC rating 53

Application • One component fire-rated for use in metal electrical boxes • It is inserted on the inside back wall of an electrical box prior to wiring



US Patent No. 6,207,085 & 6,252,167

Putty Sticks & Pads

Fire-rated pad for electrical boxes

Code	Description	Qty.
66345	18 cu./in. - stick	12
66340	6" x 7" x 1/8" thick	20
66335	7" x 7" x 1/8" thick	20



FEATURES

- Applied by hand
- No asbestos fillers
- Pads - STC rating 60
- For interior use
- Adheres to all common building surfaces

Application • Putty sticks are used to seal around penetrating items through fire-rated walls, floors and within blank openings

- Putty pads are used to maintain the hourly rating of fire-rated walls containing electrical outlet boxes and to reduce sound transmission
- Hand moldable with no curing time





FIRESTOP FOR LARGE OPENINGS

Firestop Pillows & Bags

For large temporary openings

Code	Description (Pillows)	Qty.
66362	2" x 9" x 6"	10
66363	3" x 9" x 6"	10

Code	Description (Bags)	Qty.
66896	FSB 50 ½" x 7" x 13.5"	20
66897	FSB 75 ¾" x 7" x 13.5"	35
66898	FSB 150 1½" x 7" x 13.5"	20



FEATURES

- Forms a very strong char
- No wire mesh required
- Easy to install - no tools

Application • Intumescent • Designed for use primarily in large temporary or frequently accessed openings with cables, cable trays, blank openings or multiple penetrations



Fire-Rated Mortar

For large openings

Code	Description	Qty.
66331	20 lbs. pail	1
66334	45 lbs. bag	1



FEATURES

- Non-sag adjustable consistency
- High yield per lb.
- No special tools needed

Application • Rapidly hardening compound for large openings
 • Sets without shrinking and can form a rigid, gas tight, fire resistant seal
 • Can be cut or drilled and resealed

Recommended for

- Power cables • Fiber optic
- Telephone cables • Aluminium or steel cable trays • EMT
- Copper • Steel • Cast iron pipe



Composite Sheet

For large temporary openings

Code	Description	Qty.
66320	36" x 36"	1



FEATURES

- Light weight
- Thin sheets
- Re-enterable
- No VOC

Application • Rigid fire resistive panel used to seal penetrations and restore the fire rating to floor/ceilings or walls
 • Made of reinforced, highly intumescent material bonded on one side to a galvanized steel sheet
 • Ideal for clean room applications



US Patent No. 6,207,085



SMOKE SEALANTS

Smoke & Acoustic Sealant

High-grade acrylic latex

Code	Description	Qty.
66652	20.2 oz. foil pack	12
66650	5 gal.	1

Tested to ASTM E84, ASTM E90, ASTM E1399 and air leakage in accordance to modified UL1479 and UL2079

FEATURES

- Meets LEED criteria
- Flexible set
- Easy to dispense
- Water clean up
- Use both vertically or horizontally
- Interior grade
- STC rating 69

Application • Provides a permanent seal for penetrations, membrane openings and static or dynamic joints in smoke or sound rated assemblies • In the event of a fire it will prevent the movement of smoke and impede the transfer of sound in non-fire rated assemblies

Recommended for • Metallic and nonmetallic pipes • Outlet and receptacle boxes • Membrane penetrations
 • Head of wall
 • Bottom of wall
 • Wall to wall joints

Apply with • Caulking gun
 • Trowel • Spray equipment
 • Pumping equipment;
 no mixing required



RectorSeal® RS 136

Fire block / smoke seal caulk

Code	Description	Qty.
66408	10.3 oz. cartridge	12



FEATURES

- Easy application
- Interior applications
- Water Clean-up
- ASTM E 136 compliant

Application • General purpose, residential acoustical fireblock

Recommended for

- Electrical • Plumbing • Plastic pipe
- Telephone communication systems penetrations



Draft-Block™

Expanding polyurethane foam

Code	Description	Qty.
96500	12 oz. aerosol	12

FEATURES

- Expands 3X
- Tack-free in approx. 45 min.
- No urea-formaldehyde

Application • Excellent filler which bonds and insulates
 • Fill voids, cracks, crevices and small cavities on flat or irregular surfaces • Reduces sound transmission • Totally dielectric





FIRESTOP ACCESSORIES

Caulking Guns Cartridge, foil & bulk loading

Code	Description	Qty.
66114	10.3 oz. gun	1
66115	30 oz. gun	1
66116	20.2 oz. foil gun	1
66117	Foil gun tips	25

FEATURES

- Industrial grade



Universal Collar For concrete, wood & gypsum

Code	Description	Qty.
66091	2" x 50' roll	1
66095	1" x 50' roll	1

FEATURES

- Galvanized steel

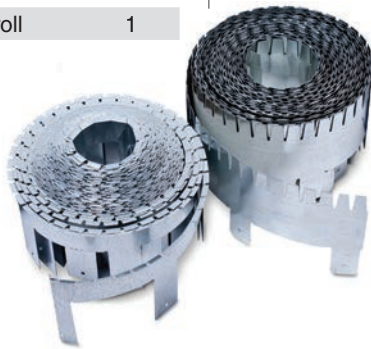

Foam Backer Rod Fills gaps prior to sealing

Code	Description	Qty.
66112	1" x 75'	1

FEATURES

- Easy to use
- Economical



6lb./ cu. ft. Safing Mineral wool backing

Code	Description	Qty.
66101	2' x 4' x 2"	8

FEATURES

- Non-combustible backing



Delta Deck Plugs 36" long

Code	Description	Qty.
66401	1-1/2" x 3-1/2" x 4-1/2"	48
66403	1-1/2" x 4-1/2" x 5-1/2"	39
66409	3" x 5" x 7"	18

FEATURES

- Non-combustible
- Mineral wool backing for fluted deck





CABLE PROTECTION

Fiberglass Tying Cord

For power cables

Code	Description	Qty.
50219	QTC250 350'	1

FEATURES

- No cable derating
- Interior & exterior use
- Prevent vertical and horizontal spread of fire
- Compatible with typical cable jacketing materials



Cable End Cap

Quick seal against moisture & corrosion

Code	Description	Qty.
50231	QC2 .75" x 1.25" red	50
50232	QC3 1" x 1.5" orange	50
50233	QC4 1.25" x 1.75" gray	25
50234	QC5 1.5" x 2" black	25

FEATURES

- No heat required
- Instant seal
- Simple to install
- Reinforced ends
- Pliable butyl mastic sealant
- Works in extreme temps



Chlorine Free Arc Tape

Fire-retardant arc tape

Code	Description	Qty.
50213	CFR 30 3" x 20'	8

FEATURES

- Use on power and control cable
- Easy wrap protection
- Utility and government approved
- Non-toxic, Low smoke
- Effective alternative to spray
- Non-halogenated
- Forms a tough ceramic tube



Arc Sleeve

For large power and utility cables

Code	Description	Qty.
50241	500/700 3'	1

FEATURES

- Fire and fault arc protection
- Easy snap-on application
- Custom dip-molded
- Fits tightly around cables
- For large electrical cables



3' Long



RELATED PRODUCTS

K.O. Dirt Blaster™ Dirt and grease stripper

Code	Description	Qty.
88438	20 oz. aerosol	12

FEATURES

- Dissolves grease quickly
- Quick drying
- Pressure washes small condenser coils without a water rinse
- Non-flammable
- No CFC's

Application

- Quickly dissolves grease
- Non-conductive; will not short out electrical equipment
- Effective on restaurant grease and other greasy surfaces

Recommended for

- Refrigeration coils
- Oil burner surfaces
- Machine parts
- Switches
- Relays
- Circuit breakers
- Motors
- Electrical components



RectorSeal® EP-200 Epoxy putty

Code	Description	Qty.
97600	2 oz.	24
97601	2 oz. refill	24
97602	Blistercard	12
97606	EP-400 4 oz.	12



FEATURES

- Mixes like putty
- Hardens in minutes
- Can be drilled, taped, filed, machined, sanded and painted
- Bonds and fills a variety of materials



- Application** • Pre-measured, high-grade epoxy and hardener formulated together in one stick • Break off the amount needed for each repair • Bonds to most surfaces

Lets-Go™ Penetrant, lubricant and freeze-up preventer

Code	Description	Qty.
73012	12 oz. aerosol	12

FEATURES

- Loosens frozen bolts, nuts & joints
- Protects from water & weather

- Application** • Covers metal surfaces with a clinging, tough, long-lasting film of lubricant • The wetting power acts quickly on rusted and seized parts • Displaces moisture from wiring and equipment



Thread Cutting Oil Dark machine thread

Code	Description	Qty.
94392	1 qt. - dark	12
94272	1 gal. - dark	6
94192	5 gal. - dark	1
94111	55 gal. - dark	1

FEATURES

- Increased lubricity/longer die life
- Penetrates quickly
- Keeps dies cool

- Application** • Designed to reduce friction • Effective coolant and anti-weld agent • An extreme pressure lubricant during thread cutting operations • Will not congeal above 20°F

- Recommended for** • Dark - hand thread cutting operations and when using low rpm machines



GoldenGrip™ Internal pipe wrench

Code	Description	Qty.
97250	Single 1/2"	6
97251	Single 3/4"	6
97252	Double 1" - 1-1/4"	3
97253	Double 1-1/2" - 2"	3
97256	Set of 4 tools	1

Sold separately in 4 sizes or as a set of 4 with durable carry case

U.S. Patent No. 6,675,679B2

FEATURES

- Self-locking & reversible
- No thread damage
- Works in tight spaces

- Application** • The right tool for quick and easy installation or extraction of pipe nipples • Self-locking, reversible internal wrench can be used with ratchets, extensions and impact wrenches

- Recommended for** • Chrome Pipe • Brass pipe • Can also be used to extract corroded pipe



Golden Pipe Shredder™ Restore welded plastic fittings

Code	Description	Qty.
98040	1-1/2"	4
98041	2"	4
98042	3"	4
98043	4"	4
98050	Set of 4 tools	1

FEATURES

- Carbide cutting blades
- Unique guiding system
- Made of heat tempered steel
- One piece body

- Application** • Reams out solvent welded plastic fittings so they can be reused • Cuts stub outs to be flush or recessed with wall • Removes cracked water closet flanges



Sold separately in 4 sizes or as a set of 4 with durable carry case



EQUIPMENT & SERVICE SUPPORTS

Fix-It-Footer Low

Low profile rubber riser

Code	Description	Qty.
87772 (RMB10L)	Fix-It-Footer Low 10"	1
87774 (RMB16L)	Fix-It-Footer Low 16"	1

H = 2"
W = 7"

FEATURES

- Ideal for rooftop support of equipment & systems
 - Weather resistant
 - Recycled crumb rubber pad
 - Recessed underside permits stability
 - Aluminum track permits the use of standard strut hardware (not included)
- Max load capacity: RMB10L - 356 lbs. RMB16L - 572 lbs.

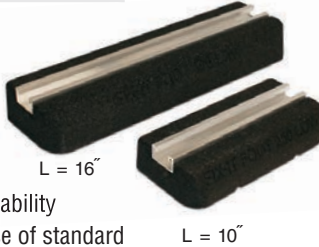

Fix-It-Footer

Additional vibration isolation and stability

Code	Description	Qty.
87771 (RMB10)	Fix-It-Footer 10"	1
87773 (RMB16)	Fix-It-Footer 16"	1
87775 (RMB24)	Fix-It-Footer 24"	1
87776 (RMB40)	Fix-It-Footer 40"	1

H = 4"
W = 7"

FEATURES

- Ideal for rooftop support of equipment & systems
 - Weather resistant
 - Recycled crumb rubber pad
 - Recessed underside permits solid stance
 - Aluminum track permits the use of standard strut hardware (not included)
- Max load capacity: RMB10 - 356 lbs. RMB16 - 572 lbs. RMB24 - 1045 lbs. RMB40 - 1420 lbs.



Multi Foot

Versatile support system

Code	Description	Qty.
87711 (RSP16)	16" Multi Foot	1
87712 (RSP24)	24" Multi Foot	2

FEATURES

- Strong and Lightweight
 - Weather resistant
 - PVC - Rubber/PVC
 - Linear track holds 1/2" hex head bolts
 - Two 7/8" long bolts included
 - Top channel accepts 1-5/8" strut
- Max load capacity: RSP16 - 572 lbs. RSP24 - 1045 lbs.

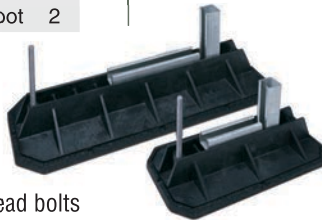

H Frame

Accepts standard 1 5/8" strut, optimum support

Code	Description	Qty.
87713 (RSPD12)	H-Frame Kit w/ 12" Square	1
87714 (RSPD18)	H-Frame Kit w/ 18" Square	1
87715 (RSPD24)	H-Frame Kit w/ 24" Square	1

FEATURES

- Ideal rooftop support of equipment & systems
- Weather resistant
- Recycled crumb rubber pad
- Accepts 1-5/8" strut (not included)
- Build custom frames & supports

Max load capacity per frame:

	87713	87714	87715
RSPD12 - 1,100 lbs.	H = 3 1/2"	H = 4 1/4"	H = 4 3/4"
RSPD18 - 1,100 lbs.	W = 13"	W = 19"	W = 25 1/4"
RSPD24 - 1,100 lbs.	L = 13"	L = 19"	L = 25 1/4"



Polymer Risers

Provides simple lightweight raised mounting support

Code	Description	Qty.
87761 (PR-351N-I)	14" Polymer Riser	20
87762 (PR-351N-M)	18" Polymer Riser	20
87763 (PR-351N-L)	39" Polymer Riser	4
87765 (PRC-351N)	End Caps	1 Pair

FEATURES

- Ideal for piping, duct runs, cable trays and condensers
 - Weather resistant PVC
 - Linear track holds 3/8" hex head bolts
 - Two 7/8" long bolts included
- Max load capacity: PR-351N-I - 308 lbs. PR-351N-M - 397 lbs. PR-351N-L - 880 lbs.

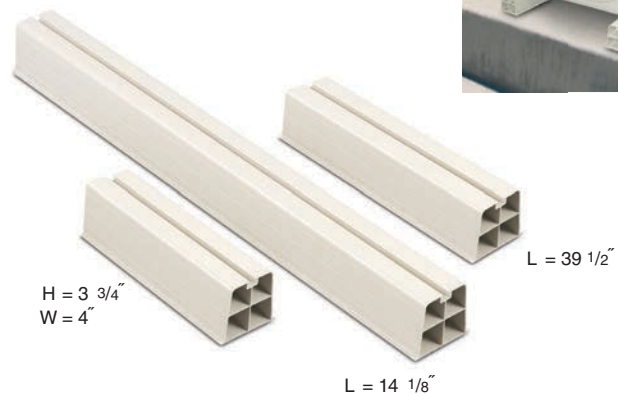



Through the use of current technology and social media, RectorSeal provides up-to-date technical information and marketing materials.

Company Homepage:

An online hub of readily available resources for our full-line of specialty chemicals and tools including: product codes, MSDS and product data sheets. Promotional literature and artwork can be easily viewed. Trade show scheduling and booth information are also updated frequently.

Social Media:

Up to the minute information from RectorSeal regarding new products, press releases, market trends and trade articles are sent directly to your wall, time-line and mobile devices.

Online Video:

Watch instructional videos on how to effectively and properly use RectorSeal products. Subscribe to our channel and receive new product videos instantly.

Online Training:

Installers can earn certifications from RectorSeal for approved field use of our specialty products. Lessons and exams can be completed at your own pace and results accessed from your personal computer. AIA CEU's are also available for architects and engineers.

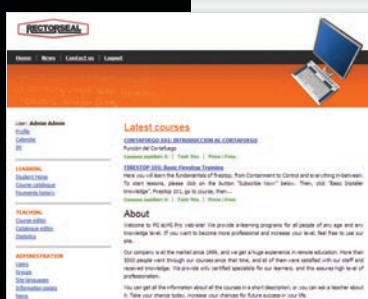
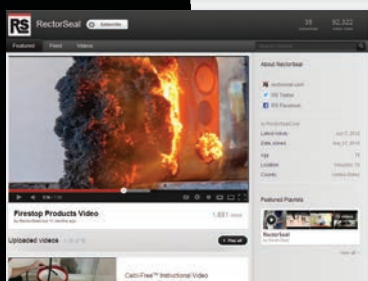

To utilize these services, visit www.rectorseal.com

Contact: RectorSeal®

2601 Spenwick Drive, Houston, TX 77055

P 713-263-8001 | 800-231-3345

F 713-263-7577 | 800-441-0051

W www.rectorseal.com

Distributed by:

All information is believed to be current at the time of printing, but our policy is one of continuous development. RectorSeal makes no warranties, express or implied, as to its accuracy. RectorSeal reserves the right to discontinue, update or change the information at any time without notice or without incurring obligations.



METACAULK PRODUCT CATALOG



- Firestopping Sealants
- Firestopping Sprays
- Joint & Wrap Strip
- Firestop Devices
- Electrical Outlets
- Large Openings
- Smoke Sealants
- Mounting Equipment

Advanced product development

Combustion control room



Product Innovation

Our family of UL approved **Metacaulk®** Firestopping products is specifically designed to fill voids in construction joints and around penetrations in fire-rated walls or floors. Many have intumescent properties and expand when exposed to heat, forming a high-strength insulating char.

On-site test furnaces



Technological Development

In 1995, an on-site fire test laboratory was built for the purpose of conducting UL witnessed burns for through-penetration and construction joint assemblies. Our laboratory has been designated by UL under their Witness Test Data Program for fire testing to UL 1479 & UL 2079.

Hose stream test



Testing & Approvals

Our on-site fire test laboratory monitors all phases of test burns as specified by ASTM E-814 (UL 1479) or ASTM E-1966 (UL 2079). We have over 1200 Tested UL systems. Having an on-site UL lab speeds the development of new firestop products & UL systems, allowing quicker response to customer needs.



Support, training & service

Intumescent properties



Quality Assurance

You can depend on RectorSeal's expertise & over 75 years of manufacturing experience. Our Quality Assurance Team covers each and every aspect of the manufacturing process: from the initial inspection of raw materials, to on-site monitoring throughout production and onto the rigorous final inspection.

Quality control



Hands-on training and seminars



Technical Service

You can depend on our knowledgeable Technical Service team to share their expertise on any of our over 350 products. We are dedicated to providing comprehensive product support to all of our customers from Architects, Engineers, Local Inspectors to contractors and the general consumer.

Training Seminars

RectorSeal offers hands-on training to properly install a variety of **Metacaulk®** Firestop Products in approved systems. Participants receive instruction on solutions to firestopping needs. Students are introduced to new products and watch live fire demonstrations of our products in tested assemblies.

Contractor grade - Code compliant



Table of Contents

Firestop Sealants

Metacaulk® 1000
 Metacaulk® MC 150+
 FlameSafe® 900+
 Metacaulk® 350i
 Metacaulk® 835+
 Metacaulk® 950
pages 6 - 8



Firestop Sprays

Metacaulk® 1200
 Cable Coating
pages 9



Track-Safe™

page 10

Joint & Wrap Strip

Joint Strip
 Wrap Strip
 Metacaulk® Intumescent Sleeves
page 11



Firestop Devices

Metacaulk® Pass-Thru
 Metacaulk® Pipe Collars
page 12

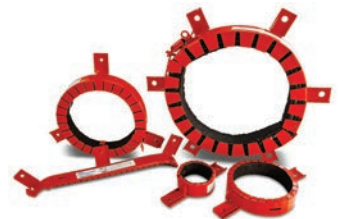

Scan for additional
 product information.



Firestopping products & solutions



Electrical Outlet Firestop

Cover Guard™
Box Guard™
Putty Sticks & Pads
page 13



For Large Openings

Firestop Pillows and Bags
Fire-Rated Mortar
Composite Sheet
page 14



Smoke Sealants

Smoke & Acoustic Sealant
RectorSeal® RS 136
Draft-Block™
page 15



Accessories

Caulking Guns
Safing
Restraining Collars
Wire Mesh
Foam Baker Rod
Deck Plugs
page 16

Cable Protection

page 17

Related Products

page 18

Mounting Equipment

page 19

metacaulk® **RECTORSEAL**

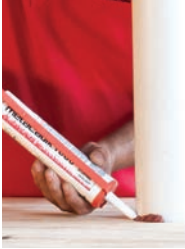

METACAUWK® FIRESTOP SEALANTS

Metacaulk® 1000

Intumescent, water-based firestop sealant

Code	Description	Qty.
66640	10.3 oz. cartridge	12
66312	20.2 oz. foil pack	12
66303	30 oz. cartridge	12
66305	1 gal.	4
66307	2 gal.	1
66309	5 gal.	1



FEATURES

- UL Classified systems up to 4 hrs.
- Highly intumescent
- VOC compliant
- Excellent freeze-thaw
- For interior use - paintable
- Meets ASTM E 814, UL 1479 & UL 2079 standards
- STC rating 62

Application • Will prevent the spread of fire through joint openings and through-penetrations
 • No dilution or mixing required • Can be used in areas with some movement • Use in fire-rated gypsum wallboard partitions, concrete walls or floors, wood floors and concrete or corrugated steel deck floor/ceiling assemblies

Recommended for • Metal • Insulated pipes
 • Fiberglass & plastic pipes • Wall construction joints • Power, telephone & DataComm cables



See ordering chart for container sizes available.

*FBC™ "System Compatible" indicates that this product has been tested, and is monitored on an ongoing basis, to assure its chemical compatibility with FlowGuard Gold®, BlazeMaster® and Corzan® pipe and fittings.

**FBC™, FlowGuard Gold®, BlazeMaster® and Corzan® are licensed trademarks of the Lubrizol Corporation.

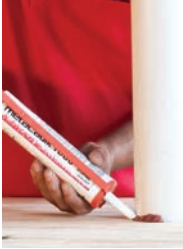

METACALK® FIRESTOP SEALANTS

Metacaulk® MC 150+

General purpose firestop sealant

Code	Description	Qty.
66648	10.3 oz. cartridge	12
66385	20.2 oz. foil pack	12
66383	30 oz. cartridge	12
66389	5 gal.	1



FEATURES

- Water-based - VOC compliant
- Good freeze-thaw
- For interior use - paintable
- Use for most common applications
- STC rating 51

Application • One component, general purpose fire-rated sealant and smoke seal for construction joints and through-penetrations on both horizontal and vertical surfaces

- Non-sag caulking grade sealant that is easy to apply as well as to retrofit
- Can be used in areas with some movement

Recommended for

- Metal
- Insulated pipes
- Fiberglass and plastic pipes
- Wall construction joints
- Power, telephone & DataComm cables



FlameSafe® 900+

Water Based Elastomeric Firestop

Code	Description (Red)	Qty.
66831	10.3 oz. Cartridge	12
66832	20.2 oz. Foil pack	12
66834	31 oz. Cartridge	6
66835	5 gal. Caulkable pail	1

Code	Description (Gray)	Qty.
66855	5 gal. Caulkable pail	1



FEATURES

- Versatile and economical
- Non-sag or Self-leveling grades
- Excellent adhesion
- Allows dynamic movement
- Flexible set
- Easy clean up
- No VOCs, non-toxic
- Low odor / Paintable
- Interior grade
- STC rating 62
- Up to 4 hour fire rating

Application • FS 900+ cures to form a flexible shield. In the event of a fire it will prevent the spread of flames and smoke through construction joint openings in fire-rated assemblies or for joints between fire-rated assemblies.

Recommended for

- Metal, insulated, fiberglass, and plastic pipes, cable and HVAC penetrations
- Concrete floor-to-floor, floor-to-wall and wall-to-wall
- Concrete • CMU and gypsum head of wall applications requiring dynamic movement.

Apply with • Caulking gun • Bulk loading gun • Trowel • Pumping equipment • No mixing required



*FBC™ System Compatible™ indicates that this product has been tested, and is monitored on an ongoing basis, to assure its chemical compatibility with FlowGuard Gold®, BlazeMaster® and Corzan® pipe and fittings.

**FBC™, FlowGuard Gold®, BlazeMaster® and Corzan® are licensed trademarks of the Lubrizol Corporation.

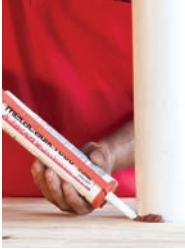

METACAUWK® FIRESTOP SEALANTS cont.

Metacaulk® 350i

Intumescent firestop sealant

Code	Description	Qty.
66616	10.3 oz. cartridge	12
66611	20.2 oz. foil pack	12
66613	5 gal.	1



FEATURES

- Highly intumescent
- Excellent freeze-thaw
- STC rating 53

Application • One component, general purpose sealant and smoke seal
 • Intumescent, water-based, non-sag caulking grade sealant that is easy to apply and great for retrofits • Can be used in areas with some movement

Recommended for

- Metal • Insulated pipes
- Fiberglass & plastic pipes
- Wall construction joints
- Power, telephone & DataComm cables



Metacaulk® 835+

Elastomeric, Silicone firestop sealant

Code	Description	Qty.
66645	10.15 oz. cartridge	12
66019	5 gal.	1
66300	20.2 oz. Caulk Grade foil pack	12
66301	20.2 oz. Self Leveling foil pack	12



FEATURES

- Exterior / Interior use
- Water resistant
- STC rating 55

Application • Used in systems where dynamic movement is expected
 • Resistant to water & chemical exposure

Recommended for

- EMT • Insulated and uninsulated steel pipe
- Construction and control joints • Expansion joints



Also available in 5 gal. pail.

Metacaulk® 950

Interior, water-based sealant

Code	Description	Qty.
66643	10.3 oz. cartridge	12



FEATURES

- Interior use
- VOC compliant
- Forms a hard char
- Non-combustible

Application • Formulated with inorganic materials which will not create smoke or toxic gases when exposed to fire • For interior applications only • Resistant to chemical exposure • Not for use in vibration or wet environments

Recommended for

- PVC & CPVC pipe on closed (pressure) systems
- EMT • Steel • Copper • Aluminum



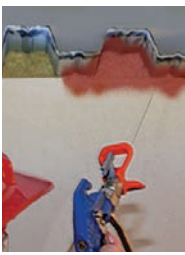

METACALK® FIRESTOP SPRAYS

Metacalk® 1200

Spray & caulk firestop mastic

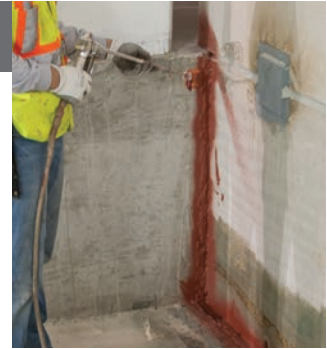

Code	Description - (Red)	Qty.
66379	5 gal. spray	1
66292	20.2 oz. foil pk	12
66015	30 oz. cartridge	12
66387	5 gal. caulk grade	1
66529	5 gal spray (USA)	1
66521	1 qt. self leveling	12
66523	5 gal. self leveling	1
Code	Description (White)	Qty.
66527	5 gal. spray	1
66525	30 oz. cartridge	12
66526	5 gal. spray (USA)	1
66386	5 gal. caulk grade	1

Application • Excellent fire-rated sealant, cures to an elastomeric seal suitable for dynamic movement
 • Available in 3 consistencies: spray allows fast, economical installation on long joint runs, self leveling is made for horizontal application and caulk grade is a non-sag sealant

Recommended for • Construction joints such as: top of the wall, curtain wall perimeter, expansion, control and etc. • Cable trays



FEATURES

- UL Classified systems up to 4 hrs.
- Sprayable, brushable & trowelable
- Flexible - elastomeric
- Allows dynamic movement
- Excellent smoke seal
- Good freeze-thaw
- VOC compliant
- STC rating 65

Sprayable 5 gal. pail
 also available - red & white.



Cable Coating

Industrial strength coating for power cables

Code	Description	Qty.
50250	5 gal.	1



FEATURES

- No cable derating
- Exterior / Interior use

Application • Water-based heavy duty spray coating designed to prevent vertical and horizontal spread of fire along grouped or single communication or power cables • Compatible with and adheres to typical cable jacketing materials





JOINT/WRAP STRIP & FIRESTOP DEVICES

Track-Safe™

Fire resistive head of wall joints

Code	Description	Qty.
66940	5/8" x 1 1/2" x 10'	20



FEATURES

- Up to 2 hours F rating
- Dynamic movement
- 100% unencumbered joint extension
- One sided installation
- L-Rating <1 CFM
- STC rating 57

Application • Installed on dynamic and static head of wall & bottom of wall joints where deep leg track and steel studs are used • 100% Compression & extension capabilities as well as drift movement with zero fatigue of joint and firestop material on deep leg track in steel stud wall assemblies





JOINT/WRAP STRIP & FIRESTOP DEVICES

Joint Strip

Flexible material for up to 2" wide joints

Code	Description	Qty.
66700	1" x 82' strip	6
66701	1-1/2" x 82' strip	4
66704	2" x 82' strip	3
66702	2-1/2" x 82' strip	2
66703	3" x 82' strip	2
66705	4" x 82' strip w/ adhesive	2



FEATURES

- No firestop caulk required
- Single sided application
- Simple & easy to use

Application • Flexible strip firestop material used in concrete and masonry floor and wall joints up to 2" wide • Prevents the passage of fire between joints • Plastic pipe penetrations

Recommended for • Stadium construction, tilt up panels • Curtain wall panels • Steel utility boxes • All concrete and masonry wall and floor construction joint applications • Can be used with any UL Listed sealant • Penetrations in walls & floors



US Patent No. 6,207,085

Wrap Strip

For penetrations

Code	Description	Qty.
66135	1" x 1/4" x 12'	6
66136	2" x 1/4" x 12'	4



FEATURES

- No cure time
- Easy to apply
- Long length means less waste
- Systems up to 14" PVC
- Highly intumescent

Application • Simply wrap required number of strips around penetrating item as required by system design • When exposed to heat, expands to form a strong char to seal off the penetration

Recommended for • Plastic and insulated pipe applications



US Patent No. 6,207,085

"FBC" System Compatible" indicates that this product has been tested, and is monitored on an ongoing basis, to assure its chemical compatibility with FlowGuard Gold®, BlazeMaster® and Corzan® pipe and fittings. "FBC", FlowGuard Gold®, BlazeMaster® and Corzan® are licensed trademarks of the Lubrizol Corporation.

Metacaulk® Intumescent Sleeve

Firestop Device

Code	Description	Qty.
66584	For 2", 3" & 4" Pipe	6
66582	For 6" & 8" Pipe	1



FEATURES

- No steel bolts or fasteners
- Can be retrofitted
- Flexible

Application • Firestop through penetrations with a single sleeve • Ideal for combustible pipes penetrating a concrete fluted deck assembly

Recommended for • PVC • cc-PVC • CPVC • FRPP • PP • ABS • Rigid non-metallic conduit installations

US Patent No. 6,207,085



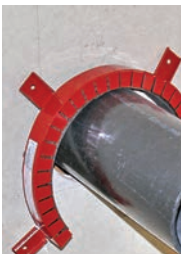

JOINT/WRAP STRIP & FIRESTOP DEVICES

Metacaulk® Pass-Thru

Engineered Firestop Sleeve

Code	Description	Qty.
66770	2-½" square	6
66773	4" square	6
66776	2" round	6
66779	4" round	6
66740	2-½" single sq. bracket	6
66743	2-½" double sq. bracket	3
66746	2-½" triple sq. bracket	2
66749	2-½" sixplex sq. bracket	1
66752	4" single sq. bracket	6
66755	4" double sq. bracket	3
66758	4" triple sq. bracket	2
66761	4" sixplex sq. bracket	1
66764	2" round bracket	6
66767	4" round bracket	6



FEATURES

- Easy to install & change cables
- Great for retrofit
- Highly intumescent
- Industry leading "L" rating

Application • Seals cables or pipes that penetrate thru 1 & 2 hour fire rated walls & floors • Square or round shaped steel sleeves with intumescent material • Opens for easy installation, retrofit or removal of cables

Recommended for • Electrical • DataComm • Communication cables • Pipes



US Patent No. 6,207,085

Foam insert replacements available

Metacaulk® Pipe Collars

Prefabricated firestop system

Code	Description	Qty.
66352	1-½"	12
66353	2"	12
66350	3"	6
66351	4"	6
66354	6"	2



FEATURES

- No measurements of material
- Fits in limited access areas
- 25% reduction of installation time

Application • UL classified for both open and closed pipe systems • Simple locking mechanism for easy installation

Recommended for • PVC • CPVC • ABS

- PVC foam core • ABS foam core
- FRPP • PEX pipe • Electrical cable
- Contact Tech Services for other options

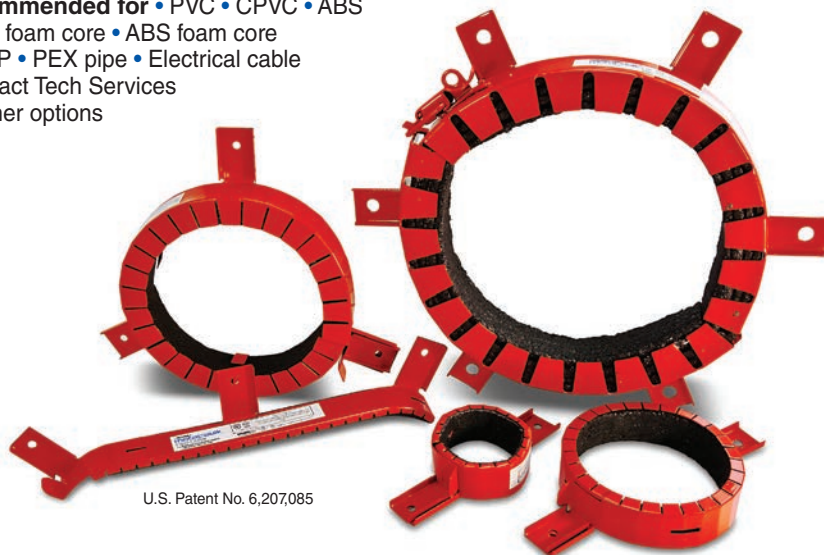

U.S. Patent No. 6,207,085



ELECTRICAL OUTLET FIRESTOP

Cover Guard™

Fire-rated gasket for electrical boxes

Code	Description	Qty.
66272	Single receptacle	50
66270	Double receptacle	50
66276	Single switch	50
66274	Double switch	50
66265	Single decor	50
66266	Double decor	50



FEATURES

- Reduces sound transmission
- Easy to install
- Highly intumescent
- STC rating 54

Application • A single component fire-rated gasket for use with electrical boxes to re-establish fire-rating of assemblies with electrical box penetrations

- Fits under the cover plate and does not take up interior box volume



US Patent No. 6,207,085; 6,252,167 & 7,348,484

Box Guard™

Fire-rated insert for electrical boxes

Code	Description	Qty.
66366	Single box	50
66367	Double box	50
66369	4- ¹¹ / ₁₆ " x 4- ¹¹ / ₁₆ "	50



FEATURES

- Adheres to back of electrical box
- Non-conductive
- Highly intumescent
- STC rating 53

Application • One component fire-rated for use in metal electrical boxes • It is inserted on the inside back wall of an electrical box prior to wiring



US Patent No. 6,207,085 & 6,252,167

Putty Sticks & Pads

Fire-rated pad for electrical boxes

Code	Description	Qty.
66345	18 cu./in. - stick	12
66340	6" x 7" x 1/8" thick	20
66335	7" x 7" x 1/8" thick	20



FEATURES

- Applied by hand
- No asbestos fillers
- Pads - STC rating 60
- For interior use
- Adheres to all common building surfaces

Application • Putty sticks are used to seal around penetrating items through fire-rated walls, floors and within blank openings

- Putty pads are used to maintain the hourly rating of fire-rated walls containing electrical outlet boxes and to reduce sound transmission • Hand moldable with no curing time





FIRESTOP FOR LARGE OPENINGS

Firestop Pillows & Bags

For large temporary openings

Code	Description (Pillows)	Qty.
66362	2" x 9" x 6"	10
66363	3" x 9" x 6"	10

Code	Description (Bags)	Qty.
66896	FSB 50 ½"x 7"x 13.5"	20
66897	FSB 75 ¾"x 7"x 13.5"	35
66898	FSB 150 1½"x 7"x 13.5"	20



FEATURES

- Forms a very strong char
- No wire mesh required
- Easy to install - no tools

Application • Intumescent • Designed for use primarily in large temporary or frequently accessed openings with cables, cable trays, blank openings or multiple penetrations



Fire-Rated Mortar

For large openings

Code	Description	Qty.
66331	20 lbs. pail	1
66334	45 lbs. bag	1



FEATURES

- Non-sag adjustable consistency
- High yield per lb.
- No special tools needed

Application • Rapidly hardening compound for large openings
 • Sets without shrinking and can form a rigid, gas tight, fire resistant seal
 • Can be cut or drilled and resealed

Recommended for

- Power cables • Fiber optic
- Telephone cables • Aluminium or steel cable trays • EMT
- Copper • Steel • Cast iron pipe



Composite Sheet

For large temporary openings

Code	Description	Qty.
66320	36" x 36"	1



FEATURES

- Light weight
- Thin sheets
- Re-enterable
- No VOC

Application • Rigid fire resistive panel used to seal penetrations and restore the fire rating to floor/ceilings or walls
 • Made of reinforced, highly intumescent material bonded on one side to a galvanized steel sheet
 • Ideal for clean room applications



US Patent No. 6,207,085



SMOKE SEALANTS

Smoke & Acoustic Sealant

High-grade acrylic latex

Code	Description	Qty.
66652	20.2 oz. foil pack	12
66650	5 gal.	1

Tested to ASTM E84, ASTM E90, ASTM E1399 and air leakage in accordance to modified UL1479 and UL2079

FEATURES

- Meets LEED criteria
- Flexible set
- Easy to dispense
- Water clean up
- Use both vertically or horizontally
- Interior grade
- STC rating 69

Application • Provides a permanent seal for penetrations, membrane openings and static or dynamic joints in smoke or sound rated assemblies • In the event of a fire it will prevent the movement of smoke and impede the transfer of sound in non-fire rated assemblies

Recommended for • Metallic and nonmetallic pipes • Outlet and receptacle boxes • Membrane penetrations
 • Head of wall
 • Bottom of wall
 • Wall to wall joints

Apply with • Caulking gun
 • Trowel • Spray equipment
 • Pumping equipment;
 no mixing required

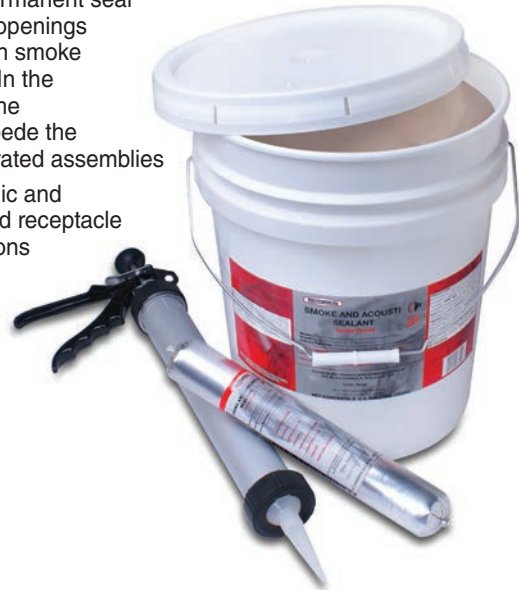

RectorSeal® RS 136

Fire block / smoke seal caulk

Code	Description	Qty.
66408	10.3 oz. cartridge	12



FEATURES

- Easy application
- Interior applications
- Water Clean-up
- ASTM E 136 compliant

Application • General purpose, residential acoustical fireblock

Recommended for

- Electrical • Plumbing • Plastic pipe
- Telephone communication systems penetrations



Draft-Block™

Expanding polyurethane foam

Code	Description	Qty.
96500	12 oz. aerosol	12

FEATURES

- Expands 3X
- Tack-free in approx. 45 min.
- No urea-formaldehyde

Application • Excellent filler which bonds and insulates
 • Fill voids, cracks, crevices and small cavities on flat or irregular surfaces • Reduces sound transmission • Totally dielectric





FIRESTOP ACCESSORIES

Caulking Guns Cartridge, foil & bulk loading

Code	Description	Qty.
66114	10.3 oz. gun	1
66115	30 oz. gun	1
66116	20.2 oz. foil gun	1
66117	Foil gun tips	25

FEATURES

- Industrial grade



Universal Collar For concrete, wood & gypsum

Code	Description	Qty.
66091	2" x 50' roll	1
66095	1" x 50' roll	1

FEATURES

- Galvanized steel

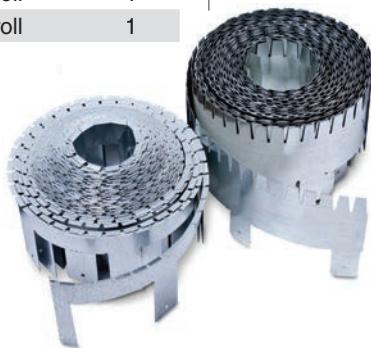

Foam Backer Rod Fills gaps prior to sealing

Code	Description	Qty.
66112	1" x 75'	1

FEATURES

- Easy to use
- Economical



6lb./ cu. ft. Safing Mineral wool backing

Code	Description	Qty.
66101	2' x 4' x 2"	8

FEATURES

- Non-combustible backing



Delta Deck Plugs 36" long

Code	Description	Qty.
66401	1-1/2" x 3-1/2" x 4-1/2"	48
66403	1-1/2" x 4-1/2" x 5-1/2"	39
66409	3" x 5" x 7"	18

FEATURES

- Non-combustible
- Mineral wool backing for fluted deck





CABLE PROTECTION

Fiberglass Tying Cord

For power cables

Code	Description	Qty.
50219	QTC250 350'	1

FEATURES

- No cable derating
- Interior & exterior use
- Prevent vertical and horizontal spread of fire
- Compatible with typical cable jacketing materials



Cable End Cap

Quick seal against moisture & corrosion

Code	Description	Qty.
50231	QC2 .75" x 1.25" red	50
50232	QC3 1" x 1.5" orange	50
50233	QC4 1.25" x 1.75" gray	25
50234	QC5 1.5" x 2" black	25

FEATURES

- No heat required
- Instant seal
- Simple to install
- Reinforced ends
- Pliable butyl mastic sealant
- Works in extreme temps



Chlorine Free Arc Tape

Fire-retardant arc tape

Code	Description	Qty.
50213	CFR 30 3" x 20'	8

FEATURES

- Use on power and control cable
- Easy wrap protection
- Utility and government approved
- Non-toxic, Low smoke
- Effective alternative to spray
- Non-halogenated
- Forms a tough ceramic tube



Arc Sleeve

For large power and utility cables

Code	Description	Qty.
50241	500/700 3'	1

FEATURES

- Fire and fault arc protection
- Easy snap-on application
- Custom dip-molded
- Fits tightly around cables
- For large electrical cables



3' Long



RELATED PRODUCTS

K.O. Dirt Blaster™ Dirt and grease stripper

Code	Description	Qty.
88438	20 oz. aerosol	12

FEATURES

- Dissolves grease quickly
- Quick drying
- Pressure washes small condenser coils without a water rinse
- Non-flammable
- No CFC's

Application

- Quickly dissolves grease
- Non-conductive; will not short out electrical equipment
- Effective on restaurant grease and other greasy surfaces

Recommended for

- Refrigeration coils
- Oil burner surfaces
- Machine parts
- Switches
- Relays
- Circuit breakers
- Motors
- Electrical components



RectorSeal® EP-200 Epoxy putty

Code	Description	Qty.
97600	2 oz.	24
97601	2 oz. refill	24
97602	Blistercard	12
97606	EP-400 4 oz.	12



FEATURES

- Mixes like putty
- Hardens in minutes
- Can be drilled, taped, filed, machined, sanded and painted
- Bonds and fills a variety of materials



- Application** • Pre-measured, high-grade epoxy and hardener formulated together in one stick • Break off the amount needed for each repair • Bonds to most surfaces

Lets-Go™ Penetrant, lubricant and freeze-up preventer

Code	Description	Qty.
73012	12 oz. aerosol	12

FEATURES

- Loosens frozen bolts, nuts & joints
- Protects from water & weather

- Application** • Covers metal surfaces with a clinging, tough, long-lasting film of lubricant • The wetting power acts quickly on rusted and seized parts • Displaces moisture from wiring and equipment



Thread Cutting Oil Dark machine thread

Code	Description	Qty.
94392	1 qt. - dark	12
94272	1 gal. - dark	6
94192	5 gal. - dark	1
94111	55 gal. - dark	1

FEATURES

- Increased lubricity/longer die life
- Penetrates quickly
- Keeps dies cool

- Application** • Designed to reduce friction • Effective coolant and anti-weld agent • An extreme pressure lubricant during thread cutting operations • Will not congeal above 20°F

- Recommended for** • Dark - hand thread cutting operations and when using low rpm machines



GoldenGrip™ Internal pipe wrench

Code	Description	Qty.
97250	Single 1/2"	6
97251	Single 3/4"	6
97252	Double 1" - 1-1/4"	3
97253	Double 1-1/2" - 2"	3
97256	Set of 4 tools	1

Sold separately in 4 sizes or as a set of 4 with durable carry case

U.S. Patent No. 6,675,679B2

FEATURES

- Self-locking & reversible
- No thread damage
- Works in tight spaces

- Application** • The right tool for quick and easy installation or extraction of pipe nipples • Self-locking, reversible internal wrench can be used with ratchets, extensions and impact wrenches

- Recommended for** • Chrome Pipe • Brass pipe • Can also be used to extract corroded pipe



Golden Pipe Shredder™ Restore welded plastic fittings

Code	Description	Qty.
98040	1-1/2"	4
98041	2"	4
98042	3"	4
98043	4"	4
98050	Set of 4 tools	1

FEATURES

- Carbide cutting blades
- Unique guiding system
- Made of heat tempered steel
- One piece body

- Application** • Reams out solvent welded plastic fittings so they can be reused • Cuts stub outs to be flush or recessed with wall • Removes cracked water closet flanges



Sold separately in 4 sizes or as a set of 4 with durable carry case



EQUIPMENT & SERVICE SUPPORTS

Fix-It-Footer Low

Low profile rubber riser

Code	Description	Qty.
87772 (RMB10L)	Fix-It-Footer Low 10"	1
87774 (RMB16L)	Fix-It-Footer Low 16"	1

H = 2"
W = 7"

FEATURES

- Ideal for rooftop support of equipment & systems
 - Weather resistant
 - Recycled crumb rubber pad
 - Recessed underside permits stability
 - Aluminum track permits the use of standard strut hardware (not included)
- Max load capacity: RMB10L - 356 lbs. RMB16L - 572 lbs.

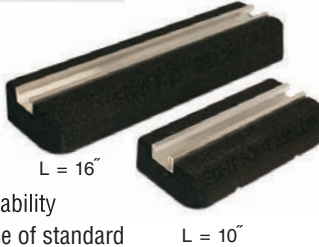

Fix-It-Footer

Additional vibration isolation and stability

Code	Description	Qty.
87771 (RMB10)	Fix-It-Footer 10"	1
87773 (RMB16)	Fix-It-Footer 16"	1
87775 (RMB24)	Fix-It-Footer 24"	1
87776 (RMB40)	Fix-It-Footer 40"	1

H = 4"
W = 7"

FEATURES

- Ideal for rooftop support of equipment & systems
 - Weather resistant
 - Recycled crumb rubber pad
 - Recessed underside permits solid stance
 - Aluminum track permits the use of standard strut hardware (not included)
- Max load capacity: RMB10 - 356 lbs. RMB16 - 572 lbs. RMB24 - 1045 lbs. RMB40 - 1420 lbs.



Multi Foot

Versatile support system

Code	Description	Qty.
87711 (RSP16)	16" Multi Foot	1
87712 (RSP24)	24" Multi Foot	2

FEATURES

- Strong and Lightweight
 - Weather resistant
 - PVC - Rubber/PVC
 - Linear track holds 1/2" hex head bolts
 - Two 7/8" long bolts included
 - Top channel accepts 1-5/8" strut
- Max load capacity: RSP16 - 572 lbs. RSP24 - 1045 lbs.



87711	87712
H = 3 3/4"	H = 3 3/4"
W = 7"	W = 8 3/4"
L = 15 3/4"	L = 24"

H Frame

Accepts standard 1 5/8" strut, optimum support

Code	Description	Qty.
87713 (RSPD12)	H-Frame Kit w/ 12" Square	1
87714 (RSPD18)	H-Frame Kit w/ 18" Square	1
87715 (RSPD24)	H-Frame Kit w/ 24" Square	1

FEATURES

- Ideal rooftop support of equipment & systems
- Weather resistant
- Recycled crumb rubber pad
- Accepts 1-5/8" strut (not included)
- Build custom frames & supports

Max load capacity per frame:

87713	87714	87715
RSPD12 - 1,100 lbs.	H = 3 1/2"	H = 4 1/4"
RSPD18 - 1,100 lbs.	W = 13"	W = 19"
RSPD24 - 1,100 lbs.	L = 13"	L = 19"
		L = 25 1/4"



Polymer Risers

Provides simple lightweight raised mounting support

Code	Description	Qty.
87761 (PR-351N-I)	14" Polymer Riser	20
87762 (PR-351N-M)	18" Polymer Riser	20
87763 (PR-351N-L)	39" Polymer Riser	4
87765 (PRC-351N)	End Caps	1 Pair

FEATURES

- Ideal for piping, duct runs, cable trays and condensers
 - Weather resistant PVC
 - Linear track holds 3/8" hex head bolts
 - Two 7/8" long bolts included
- Max load capacity: PR-351N-I - 308 lbs. PR-351N-M - 397 lbs. PR-351N-L - 880 lbs.

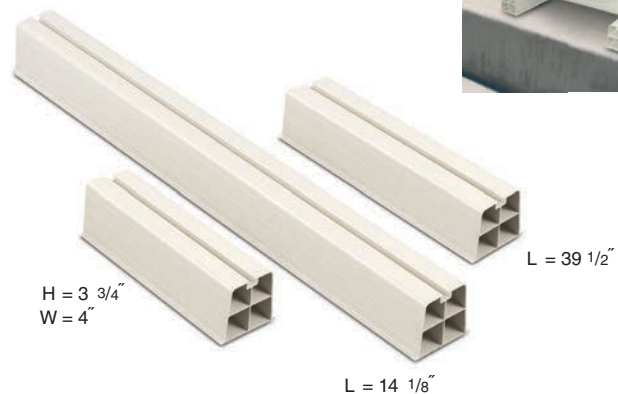



Through the use of current technology and social media, RectorSeal provides up-to-date technical information and marketing materials.

Company Homepage:

An online hub of readily available resources for our full-line of specialty chemicals and tools including: product codes, MSDS and product data sheets. Promotional literature and artwork can be easily viewed. Trade show scheduling and booth information are also updated frequently.

Social Media:

Up to the minute information from RectorSeal regarding new products, press releases, market trends and trade articles are sent directly to your wall, time-line and mobile devices.

Online Video:

Watch instructional videos on how to effectively and properly use RectorSeal products. Subscribe to our channel and receive new product videos instantly.

Online Training:

Installers can earn certifications from RectorSeal for approved field use of our specialty products. Lessons and exams can be completed at your own pace and results accessed from your personal computer. AIA CEU's are also available for architects and engineers.

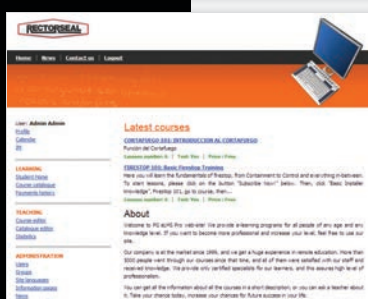
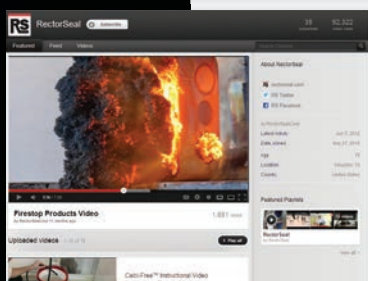
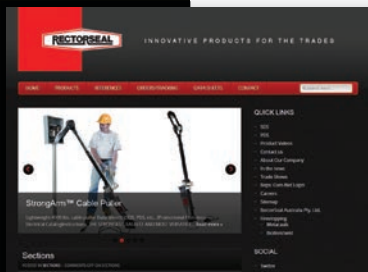

To utilize these services, visit www.rectorseal.com

Contact: RectorSeal®

2601 Spenwick Drive, Houston, TX 77055

P 713-263-8001 | 800-231-3345

F 713-263-7577 | 800-441-0051

W www.rectorseal.com

Distributed by:

All information is believed to be current at the time of printing, but our policy is one of continuous development. RectorSeal makes no warranties, express or implied, as to its accuracy. RectorSeal reserves the right to discontinue, update or change the information at any time without notice or without incurring obligations.