

Metalux AP Series

DESCRIPTION

CWPLD series is a versatile LED wraparound series with uniform, soft light at up to 60% energy savings over fluorescent light sources. This fixture has all of the commercial features contractors expect in a Metalux product, including Universal Voltage, 0-10 Volt dimming electronics and quick row or suspension mount capability. Patent pending easy mounting channel reduces installation time when row mounting fixtures together. Premium optical linear prisms provide even light distribution, minimizing the number of fixtures required to light a space. These CWPLD series are an ideal choice for commercial, retail or residential applications.

Catalog #		Type
Project		
Comments		Date
Prepared by		

SPECIFICATION FEATURES

Construction

Housing consists of cold rolled steel with embosses for extra rigidity. Post-fab painted with reflective, baked-on white enamel using pretreated metal to ensure maximum adhesion. End caps formed from a high-impact polymer for finished aesthetic. Frosted, high-impact polycarbonate lens with linear prisms provides soft, uniform, glare-free light output.

Electrical

Long-Life integrated LED and driver electrical system optimized to deliver superior performance and efficacy of 110 lm/W. Clean, bright white 4000K Color Temp LED's with minimum 80 CRI for accurate

color rendering. The CWPLD series offers 0-10V dimming from 10-100%.

Finish

Post painted with high reflective paint – standard.

Installation

Easy mounting channel reduces installation time when row mounting fixtures together. Lens and LEDs are factory preinstalled and do not need to be removed during installation. Suitable for single surface, row mounting, or suspension mount applications.

Reliability

Five year comprehensive fixture warranty. LED's projected life of 50,000 hours at 70% lumen output.

Compliance

cULus 1598 listed for damp locations. Meets FCC part 15 class B requirements. Complies with IESNA LM-79 test standards. RoHS and ADA compliant. DesignLights Consortium® Qualified and classified for DLC Standard, refer to www.designlights.org for details. Suitable for use in clothes closets when installed in accordance with the NEC 410.16 spacing requirements.



CWPLD LED

Commercial Model LED Wraparound

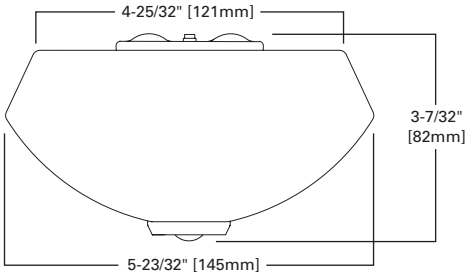
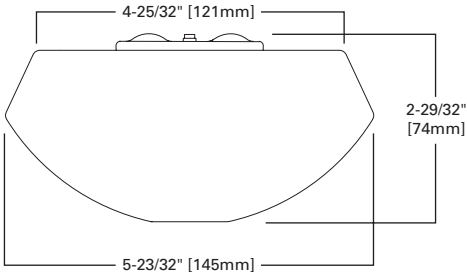

WITH SENSOR

MOUNTING DATA

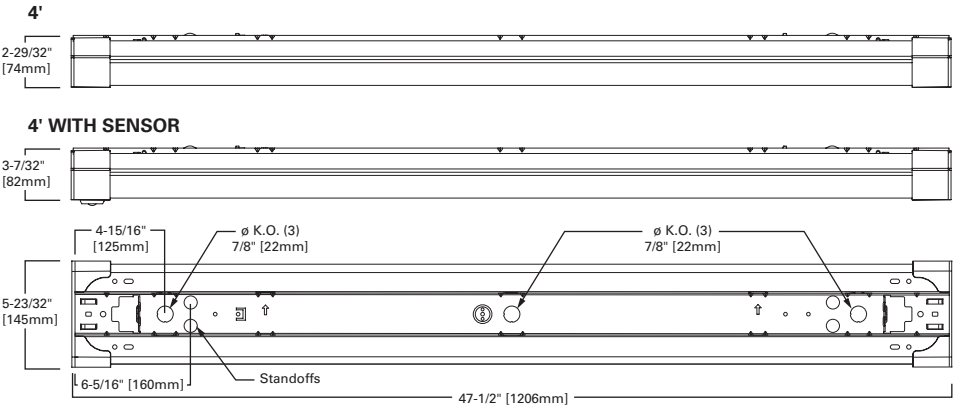

Catalog Number	Product Description	Unit UPC
4CWPLD4040C	4 LED Commercial Wraparound, 4700 lumen, 4000K UNV	080083749072
4CWPLD4040CS	4 LED Commercial Wraparound, 4700 lumen, 4000K UNV, with Occupancy Sensor	080083749065

ORDERING INFORMATION

CWPLD Standard Series Catalog Number	Typical Lumen	Input Watt	Efficacy (lm/W)	CRI	Color Temp K	Dimming Controls	Dimming Compatibility	Start Temp/Op Temp	LED Lumen Maint.	Installation
4CWPLD4040C or 4CWPLD4040CS	4,700	43	110	83	4000K	UNV 0-10V Dimming to 10%	0-10V eaton.com/lighting/resources/library/literature *see full link below	-20C/45C	L70 @ 50,000 hrs.	Surface, wall, suspended, row

*0-10V Dimming Link:

http://www.cooperindustries.com/content/dam/public/lighting/products/documents/metalux/technical_information/METALUXLED-AP-SERIES-ContrCompat-WP502001EN-tis.pdf

ACCESSORIES (ORDER SEPARATELY)

HBAYC-CHAIN/SET-U=(2) V-Hanger, 36 in. Chain, S-Hooks
 4CWPLDLNS=4 ft. Replacement Lens

SENSOR COVERAGE

SENSOR COVERAGE PATTERN TOP VIEW

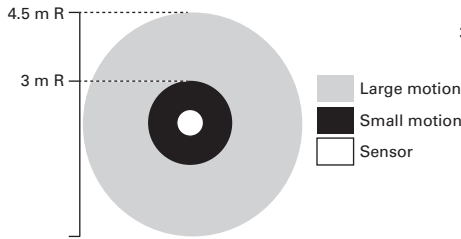

SENSOR COVERAGE PATTERN SIDE VIEW

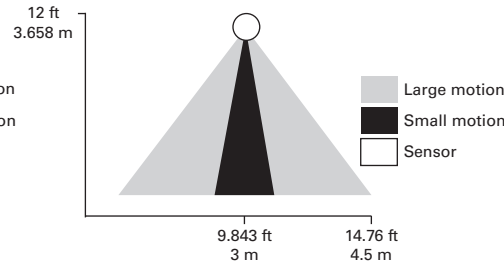

LIGHT OUTPUT VERSUS TIME

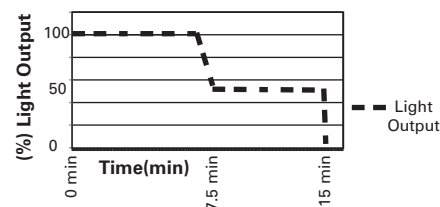

PHOTOMETRICS

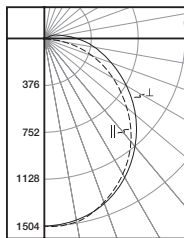

4CWPLD4040C
 Electronic Driver
 Linear LED 4000K
 Spacing criterion:
 (||) 1.24 x mounting height, (⊥) 1.27 x mounting height
 Lumens: 4753
 Input Watts: 43W
 Efficacy: 110 lm/W
 Test Report:
 4CWPLD4040C.IES

Angle	Candlepower		
	Along	45°	Across ⊥
0	1494	1494	1494
5	1499	1487	1489
10	1477	1466	1471
15	1439	1434	1444
20	1388	1388	1401
25	1325	1329	1345
30	1250	1258	1279
35	1163	1179	1207
40	1071	1091	1125
45	969	996	1039
50	864	894	946
55	754	790	851
60	637	683	754
65	513	576	658
70	386	475	563
75	258	379	478
80	140	293	394
85	45	218	323
90	1	155	255

Coefficients of Utilization

rc	Effective floor cavity reflectance																	
	80%			70%			50%			30%			10%			0%		
rw	70	50	30	70	50	30	10	50	30	10	50	30	10	50	30	10	0	
RCR																		
0	118	118	118	118	115	115	115	115	109	109	109	104	104	104	99	99	99	96
1	106	101	96	92	103	98	94	90	93	90	86	89	86	83	85	82	80	78
2	96	87	80	74	93	85	78	73	81	75	70	77	72	68	73	70	66	64
3	88	76	68	61	85	74	67	60	71	64	59	68	62	57	65	60	56	53
4	80	67	58	51	77	66	57	51	63	55	50	60	54	49	57	52	47	45
5	73	60	51	44	71	59	50	44	56	49	43	54	47	42	52	46	41	39
6	68	54	45	38	66	53	44	38	51	43	37	49	42	37	47	41	36	34
7	63	49	40	34	61	48	39	33	46	38	33	44	38	32	43	37	32	30
8	58	45	36	30	57	44	36	30	42	35	29	41	34	29	39	33	29	27
9	55	41	33	27	53	40	32	27	39	32	26	37	31	26	36	30	26	24
10	51	38	30	24	50	37	29	24	36	29	24	35	28	24	34	28	23	22

Zonal Lumen Summary

Zone	Lumens	% Fixture
0-30	1159	24.4
0-40	1898	39.9
0-60	3380	71.1
0-90	4579	96.3
0-180	4753	100.0

Luminance Data

Angle in Deg	Average 0-Deg cd/sm	Average 45-Deg cd/sm	Average 90-Deg cd/sm
45	10837	9544	9490
55	10306	8731	8826
65	9380	7800	8182
75	7467	6894	7713
85	3367	6332	7756

Metalux AP Series

DESCRIPTION

CWPLD series is a versatile LED wraparound series with uniform, soft light at up to 60% energy savings over fluorescent light sources. This fixture has all of the commercial features contractors expect in a Metalux product, including Universal Voltage, 0-10 Volt dimming electronics and quick row or suspension mount capability. Patent pending easy mounting channel reduces installation time when row mounting fixtures together. Premium optical linear prisms provide even light distribution, minimizing the number of fixtures required to light a space. These CWPLD series are an ideal choice for commercial, retail or residential applications.

Catalog #		Type
Project		
Comments		Date
Prepared by		

SPECIFICATION FEATURES

Construction

Housing consists of cold rolled steel with embosses for extra rigidity. Post-fab painted with reflective, baked-on white enamel using pretreated metal to ensure maximum adhesion. End caps formed from a high-impact polymer for finished aesthetic. Frosted, high-impact polycarbonate lens with linear prisms provides soft, uniform, glare-free light output.

Electrical

Long-Life integrated LED and driver electrical system optimized to deliver superior performance and efficacy of 110 lm/W. Clean, bright white 4000K Color Temp LED's with minimum 80 CRI for accurate

color rendering. The CWPLD series offers 0-10V dimming from 10-100%.

Finish

Post painted with high reflective paint – standard.

Installation

Easy mounting channel reduces installation time when row mounting fixtures together. Lens and LEDs are factory preinstalled and do not need to be removed during installation. Suitable for single surface, row mounting, or suspension mount applications.

Reliability

Five year comprehensive fixture warranty. LED's projected life of 50,000 hours at 70% lumen output.

Compliance

cULus 1598 listed for damp locations. Meets FCC part 15 class B requirements. Complies with IESNA LM-79 test standards. RoHS and ADA compliant. DesignLights Consortium® Qualified and classified for DLC Standard, refer to www.designlights.org for details. Suitable for use in clothes closets when installed in accordance with the NEC 410.16 spacing requirements.



CWPLD LED

Commercial Model LED Wraparound

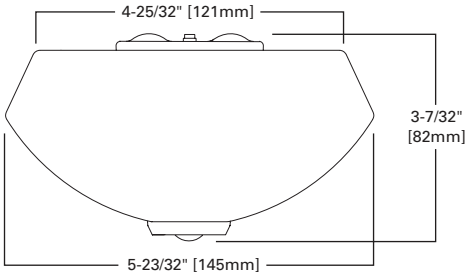
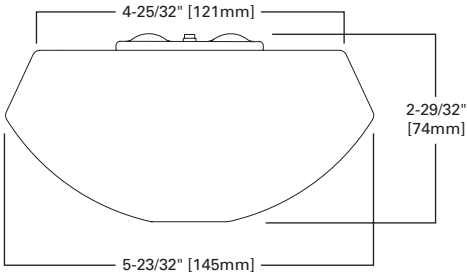

WITH SENSOR

MOUNTING DATA

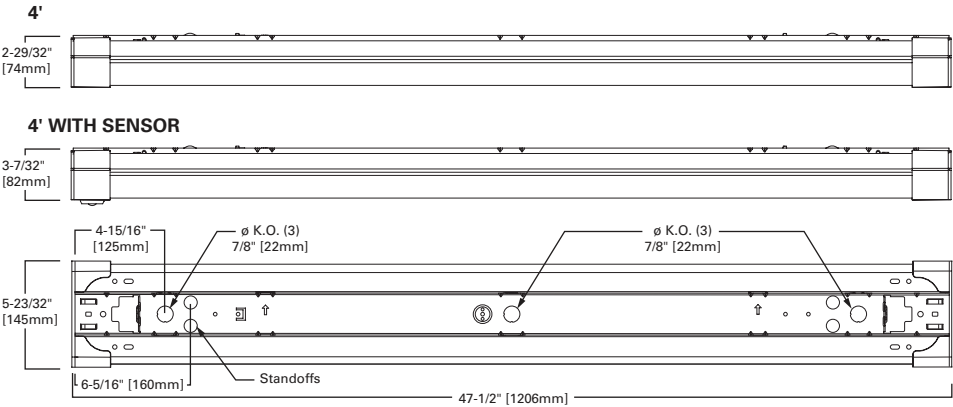

Catalog Number	Product Description	Unit UPC
4CWPLD4040C	4 LED Commercial Wraparound, 4700 lumen, 4000K UNV	080083749072
4CWPLD4040CS	4 LED Commercial Wraparound, 4700 lumen, 4000K UNV, with Occupancy Sensor	080083749065

ORDERING INFORMATION

CWPLD Standard Series Catalog Number	Typical Lumen	Input Watt	Efficacy (lm/W)	CRI	Color Temp K	Dimming Controls	Dimming Compatibility	Start Temp/Op Temp	LED Lumen Maint.	Installation
4CWPLD4040C or 4CWPLD4040CS	4,700	43	110	83	4000K	UNV 0-10V Dimming to 10%	0-10V eaton.com/lighting/resources/library/literature *see full link below	-20C/45C	L70 @ 50,000 hrs.	Surface, wall, suspended, row

*0-10V Dimming Link:

http://www.cooperindustries.com/content/dam/public/lighting/products/documents/metalux/technical_information/METALUXLED-AP-SERIES-ContrCompat-WP502001EN-tis.pdf

ACCESSORIES (ORDER SEPARATELY)

HBAYC-CHAIN/SET-U=(2) V-Hanger, 36 in. Chain, S-Hooks
 4CWPLDLNS=4 ft. Replacement Lens

SENSOR COVERAGE

SENSOR COVERAGE PATTERN TOP VIEW

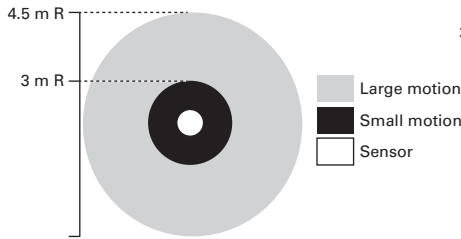

SENSOR COVERAGE PATTERN SIDE VIEW

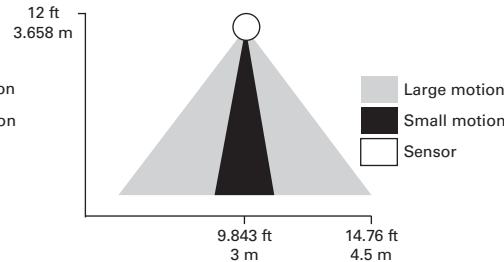

LIGHT OUTPUT VERSUS TIME

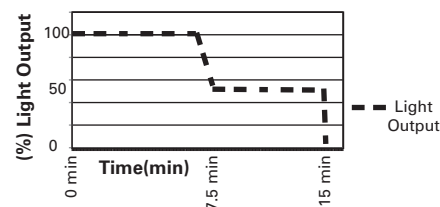

PHOTOMETRICS

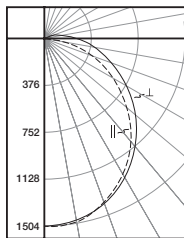

4CWPLD4040C
 Electronic Driver
 Linear LED 4000K
 Spacing criterion:
 (||) 1.24 x mounting height, (⊥) 1.27 x mounting height
 Lumens: 4753
 Input Watts: 43W
 Efficacy: 110 lm/W
 Test Report:
 4CWPLD4040C.IES

Angle	Candlepower		
	Along	45°	Across ⊥
0	1494	1494	1494
5	1499	1487	1489
10	1477	1466	1471
15	1439	1434	1444
20	1388	1388	1401
25	1325	1329	1345
30	1250	1258	1279
35	1163	1179	1207
40	1071	1091	1125
45	969	996	1039
50	864	894	946
55	754	790	851
60	637	683	754
65	513	576	658
70	386	475	563
75	258	379	478
80	140	293	394
85	45	218	323
90	1	155	255

Coefficients of Utilization

rc	Effective floor cavity reflectance																	
	80%			70%			50%			30%			10%			0%		
rw	70	50	30	10	70	50	30	10	50	30	10	50	30	10	50	30	10	0
RCR																		
0	118	118	118	118	115	115	115	115	109	109	109	104	104	104	99	99	99	96
1	106	101	96	92	103	98	94	90	93	90	86	89	86	83	85	82	80	78
2	96	87	80	74	93	85	78	73	81	75	70	77	72	68	73	70	66	64
3	88	76	68	61	85	74	67	60	71	64	59	68	62	57	65	60	56	53
4	80	67	58	51	77	66	57	51	63	55	50	60	54	49	57	52	47	45
5	73	60	51	44	71	59	50	44	56	49	43	54	47	42	52	46	41	39
6	68	54	45	38	66	53	44	38	51	43	37	49	42	37	47	41	36	34
7	63	49	40	34	61	48	39	33	46	38	33	44	38	32	43	37	32	30
8	58	45	36	30	57	44	36	30	42	35	29	41	34	29	39	33	29	27
9	55	41	33	27	53	40	32	27	39	32	26	37	31	26	36	30	26	24
10	51	38	30	24	50	37	29	24	36	29	24	35	28	24	34	28	23	22

Zonal Lumen Summary

Zone	Lumens	% Fixture
0-30	1159	24.4
0-40	1898	39.9
0-60	3380	71.1
0-90	4579	96.3
0-180	4753	100.0

Luminance Data

Angle in Deg	Average 0-Deg cd/sm	Average 45-Deg cd/sm	Average 90-Deg cd/sm
45	10837	9544	9490
55	10306	8731	8826
65	9380	7800	8182
75	7467	6894	7713
85	3367	6332	7756