

# Cable Accessory Products

3M offers accessory products to assist with splice re-jacketing, cable jacket sealing, grounding and cable preparation. Many of the products shown here are used with 3M splices and terminations. Remember to reference those sections for more product information.

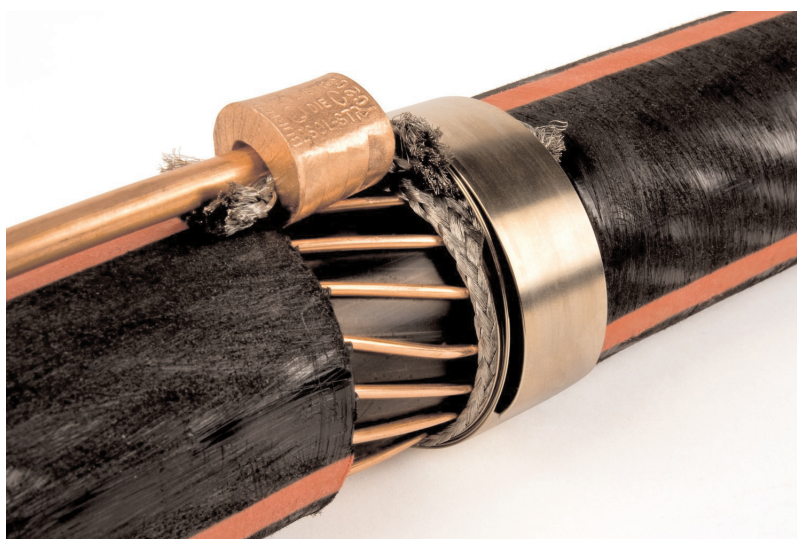

Section	Page
Outage Protection Products .....	338
Sealing and Grounding Kits .....	339-344
Splice Repair .....	345
Cable Breakout Boots and Phase Re-jacketing System .....	345-347
Sheath Seal Kits .....	347-348
Electrical Resins .....	348-352
Cold Shrink Trifurcating Accessory Kit.....	353
Cold Shrink Corrosion Protection Kits.....	354
Cold Shrink End Caps.....	354
Mounting Brackets .....	355
Preparation and Cleaning.....	356-357
3M™ Wraparound Heat Shrink Cable Repair HDCW Sleeves.....	357-358
Splice Jacketing, Re-jacketing and Cable Repair .....	359-364
3M™ Splice Jacketing and Re-jacketing Kits.....	360-364

## Overhead Conductor Animal Guard Cover

3M™ Conductor Covers CCI Series are extruded silicone rubber tubes designed for field installation over bare conductors to insulate them from adjacent phases, grounded equipment, and animal contact. These covers are made with a full-length longitudinal bias cut to allow for easy slip-on installation, and provide an increased creepage distance between the conductor and the outer surface of the cover.

The covers are offered in two thickness sizes for covering both 15 kV and 25 kV rated conductors, and are available in ACSR conductor sizes from 2 AWG–266 kcmil.

Features:

- ◆ Excellent UV, arc and ozone resistance
- ◆ Good dielectric strength, conformability and cold weather installation
- ◆ Munsel grey color
- ◆ Bias cut enables easy field installation without any special tools

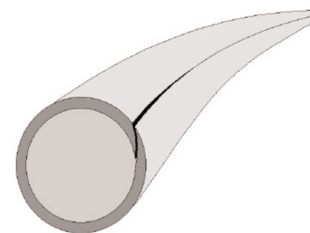

CCI Series  
Conductor Covers

**Voltage** 15–25 kV

Order No.	UPC	ACSR Conductor Size	Conductor Voltage Rating	Insulation Diameter	Insulation Thickness	Case Qty.
CCI-2-125	051141-04238	2 AWG	15 kV	0.34" (9 mm)	0.125" (3 mm)	100 ft. rolls
CCI-2/0-125	051141-04239	2/0 AWG	15 kV	0.46" (12 mm)	0.125" (3 mm)	100 ft. rolls
CCI-266-125	051141-04241	266 kcmil	15 kV	0.63" (16 mm)	0.125" (3 mm)	100 ft. rolls
CCI-2/0-200	051141-04240	2/0 AWG	25 kV	0.46" (12 mm)	0.200" (5 mm)	100 ft. rolls
CCI-266-200	051141-04242	266 kcmil	25 kV	0.63" (16 mm)	0.200" (5 mm)	100 ft. rolls

## 3M™ Electrostatic Animal Guard

This is a patented electrostatic barrier that attaches to energized electrical insulators/bushings rated up to 35 kV.

The 3M™ Electrostatic Animal Guard consists of rugged plastic with metal spokes radiating outward. When an animal touches the spokes, it receives an electric shock, similar to those generated by electrified livestock fences. The animal is not injured and power service is not interrupted.

Note: Insulator neck diameter range is defined as the diameter of the insulator in between the skirts.

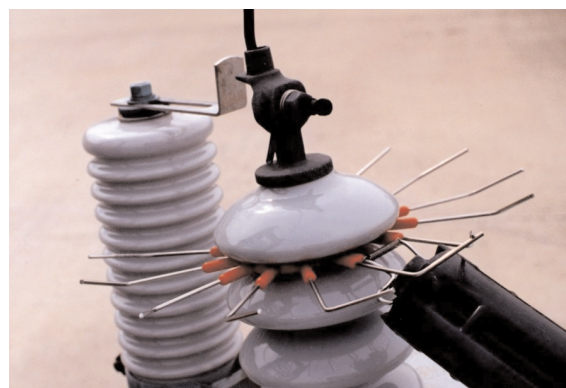

**Voltage** 35 kV and less

Order No.	UPC	Insulator Neck Diameter Range	Case Qty.
GG-7525	054007-43128	0.75"–2.50" (19,1–63,7 mm)	100
GG-1525	054007-43125	1.50"–2.50" (38,2–63,7 mm)	100
GG-2545	054007-43126	2.50"–4.50" (63,7–114,7 mm)	100
GG-4565	054007-43127	4.50"–6.50" (114,7–165,7 mm)	100

## 3M™ Cold Shrink Cable Accessory Sealing Kits 8450 Series

The 3M™ Cold Shrink Cable Accessory Sealing Kits 8450 Series are designed to seal the jacket end of power cables where elbows or other cable accessories are installed. Both the sealing tube and mastic are compatible with commonly used power cable jacketing and semiconductive materials.

Each kit contains enough materials to seal one cable jacket end. Kit contents include: Cold Shrink sealing tube; 6" (15,24 cm) mastic sealing strips (3 strips in 8452/8452L, 4 strips in 8453, 6 strips in 8454); and Instruction sheet.

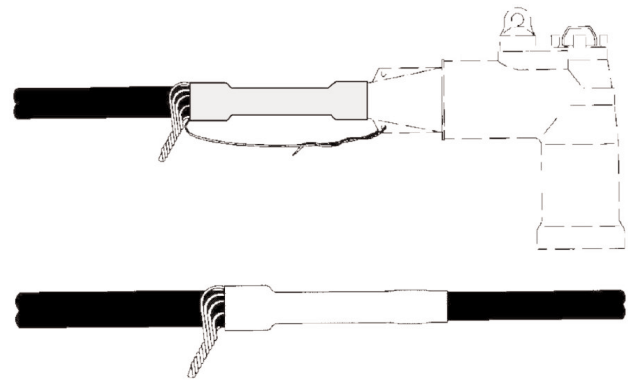

<b>Voltage</b>	15-35 kV
<b>Cable/Shielding Type</b>	Jacketed Concentric Neutral (JCN)
<b>Component Type</b>	Accessory Kit
<b>RoHS 2011/65/EU</b>	Yes

	8452	8452L	8453	8454
UPC	054007-08336	054007-44312	054007-09676	054007-49938
Typical Expanded Tube Length	4.50" (114 mm)	5.00" (127 mm)	6.50" (165 mm)	7.50" (190 mm)
Typical Relaxed Tube Length	6.00" (150 mm)	6.50" (165 mm)	8.00" (200 mm)	9.00" (225 mm)
Expanded Tube Diameter	2.12" (53 mm)	2.12" (53 mm)	2.85" (73 mm)	3.87" (98 mm)
Minimum Seal Diameter	0.95" (24 mm)	0.95" (24 mm)	1.28" (33 mm)	1.60" (41 mm)
Maximum Installed Diameter	1.94" (49 mm)	1.94" (49 mm)	2.67" (68 mm)	3.50" (89 mm)
Cable Size for 15 kV Class	2-4/0 AWG (35-100 mm <sup>2</sup> )	2-4/0 AWG (35-100 mm <sup>2</sup> )	2/0 AWG-1000 kcmil (70-500 mm <sup>2</sup> )	750-1500 kcmil (380-725 mm <sup>2</sup> )
Cable Size for 25 kV Class	2-2/0 AWG (35-50 mm <sup>2</sup> )	2-2/0 AWG (35-50 mm <sup>2</sup> )	1/0 AWG-750 kcmil (60-380 mm <sup>2</sup> )	600-1250 kcmil (325-625 mm <sup>2</sup> )
Cable Size for 35 kV Class	1/0 AWG (60 mm <sup>2</sup> )	1/0 AWG (60 mm <sup>2</sup> )	1/0 AWG-500 kcmil (60-250 mm <sup>2</sup> )	350-1000 kcmil (180-500 mm <sup>2</sup> )
Kits per Case	10	10	10	10

## Sealing and Grounding Kits

### 3M™ Cold Shrink Shield Adapter Kits 8459/8460 Series

3M™ Cold Shrink Shield Adapter Kits are designed for grounding and sealing tape shield, wire shield and Unishield® power cables when using cable accessories such as elbows, modular splices and terminations. The Shield Adapter Kit design provides a fault current capacity of 600 amps on 15–35 kV class cables.

These cold shrink kits require no heat, special tools or special skills to install. The cold shrink kits come complete with all necessary components (except the cable accessory) and are installed in a few simple steps. We've even attached a "bleeder wire" to the ground strap eliminating the need for additional wire and connectors.

Each kit contains enough material to ground one cable accessory.

<b>Voltage</b>	15-35 kV
<b>Current</b>	600 Ampere
<b>Cable/Shielding Type</b>	Tape Shield, Wire Shield, Unishield®
<b>Component Type</b>	Accessory

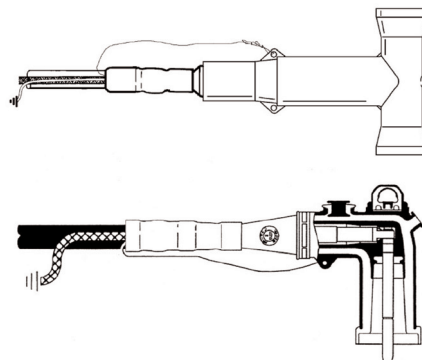

Order No.	UPC	Jacket O.D. Size	Cond. Size 5/8 kV	Cond. Size 15 kV	Cond. Size 25 kV	Cond. Size 35 kV	Kits/Case
8459	051128-53236	0.59"-1.05" (15,0-26,6 mm)	8-1 AWG (10-38 mm <sup>2</sup> )	-	-	-	3
8460	054007-41458	0.83"-1.64" (21,1-41,6 mm)	1/0 AWG-350 kcmil (50-200 mm <sup>2</sup> )	2 AWG-250 kcmil (35-150 mm <sup>2</sup> )	2 AWG-250 kcmil (35-150 mm <sup>2</sup> )	2-1/0 AWG (35-60 mm <sup>2</sup> )	3
8461	054007-41459	1.27"-2.17" (32,3-55,1 mm)	500-1000 kcmil (240-500 mm <sup>2</sup> )	350-1000 kcmil (185-500 mm <sup>2</sup> )	350-750 kcmil (185-500 mm <sup>2</sup> )	2/0 AWG-350 kcmil (70-200 mm <sup>2</sup> )	3
8462	051128-53131	1.70"-2.60" (43,2-66,0 mm)	-	1250-1750 kcmil (600-850 mm <sup>2</sup> )	1000-1500 kcmil (600-725 mm <sup>2</sup> )	500-1000 kcmil (240-500 mm <sup>2</sup> )	3



## Sealing and Grounding Kits

### 3M™ Ground Strap Assembly GS Series

3M™ Ground Strap Assembly Kits GS Series are designed for grounding tape- and wire-shielded power cables.

**Voltage** 5-35 kV

**Cable/Shielding Type** Tape- & Wire-Shielded Power Cables

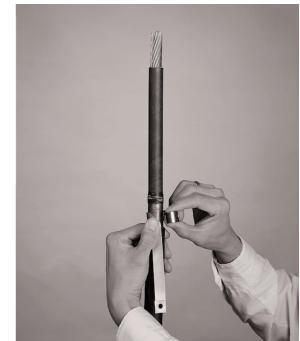

Order No.	UPC 054007-	Strap (LxW)	Conductor Size 5 kV-100% (90 mil)	Conductor Size 5 kV- 133%/ 8 kV-100% (115 mil)	Conductor Size 8 kV- 133% (140 mil)	Conductor Size 15 kV- 100% (175 mil)	Conductor Size 15 kV- 133% (220 mil)	Conductor Size 25 kV (260 mil)	Conductor Size 35 kV (345 mil)	Bags/ Case
GS-1	33976	4.75" x 0.31" (120,7 x 7,9 mm)	8-3/0 AWG (10-80 mm <sup>2</sup> )	8-1/0 AWG (10-50 mm <sup>2</sup> )	8-1 AWG (10-38 mm <sup>2</sup> )	-	-	-	-	9
GS-2	33977	7.12" x 0.62" (180,8 x 15,7 mm)	2/0 AWG-750 kcmil (70-325 mm <sup>2</sup> )	1/0 AWG-750 kcmil (60-325 mm <sup>2</sup> )	1 AWG-600 kcmil (50-300 mm <sup>2</sup> )	2 AWG-500 kcmil (35-250 mm <sup>2</sup> )	2 AWG-350 kcmil (35-180 mm <sup>2</sup> )	2 AWG-400 kcmil (35-200 mm <sup>2</sup> )	1/0 AWG- 300 kcmil (60-150 mm <sup>2</sup> )	9
GS-3	33978	6.87" x 0.62" (175,0 x 15,7 mm)	600-2000 kcmil (325-1000 mm <sup>2</sup> )	500-2000 kcmil (300-1000 mm <sup>2</sup> )	400-1750 kcmil (240-850 mm <sup>2</sup> )	350-1750 kcmil (180-850 mm <sup>2</sup> )	250-1500 kcmil (125-725 mm <sup>2</sup> )	3/0 AWG- 1000 kcmil (95-500 mm <sup>2</sup> )	1/0 AWG- 750 kcmil (60-325 mm <sup>2</sup> )	9

### 3M™ Constant Force Spring

3M™ Constant Force Springs are a range of solderless connections for earthing or grounding use on:

- ♦ Lead and aluminium cable sheaths
- ♦ Cable screening tapes or wires
- ♦ Steel or aluminum armour wires

The springs are easily applied by rolling onto the cable core or outside diameter, whereupon it continues to exert a constant radial pressure.

**RoHS 2011/65/EU** Yes





Order No.	UPC	Application Range	Width	Springs per Case
CFS-.47/1.78	054007-42372	0.50"-0.75" (12,7-19,0 mm)	0.500" (12,7 mm)	30
CFS-.80/1.50	054007-42374	0.80"-1.50" (20,3-38,1 mm)	0.625" (15,9 mm)	30
CFS-1.00/2.20	054007-42375	1.00"-2.20" (25,4-56,0 mm)	0.625" (15,9 mm)	30
CFS-1.50-3.00	054007-42376	1.50"-3.00" (38,1-76,2 mm)	0.625" (15,9 mm)	9
CFS-1.50/3.00W	054007-42378	1.50"-3.00" (38,1-76,2 mm)	0.750" (19,0 mm)	9
CFS-1.80/4.00	054007-42379	1.80"-4.00" (45,7-101,6 mm)	0.625" (15,9 mm)	9

## 3M™ Shield Grounding Accessory Kits GSK

3M™ Shield Grounding Accessory Kits GSK Series are designed to convert concentric neutral (CN) or jacketed concentric neutral (JCN) QT-II or QT-III termination kits for use on longitudinally corrugated (LC) and tape shielded power cables. The GSK kits eliminate the need to stock separate termination kits for shielded power cables. The ground braids provided in the GSK kits are designed for applications where high ampacity grounding is desired.

\* **Conductor Size Ranges expressed in AWG & kcmil.**

<b>Voltage</b>	5–35 kV	 Tape Shielded Cable
<b>Cable/Shielding Type</b>	Tape Shield, Longitudinally Corrugated (LC)	
<b>Shield Diameter Range (GSK-22)</b>	0.74"–1.18" (18,8–30,0 mm)	
<b>Shield Diameter Range (GSK-34)</b>	0.82"–1.63" (20,8–41,4 mm)	
<b>Shield Diameter Range (GSK-56)</b>	1.15"–2.42" (29,2–61,5 mm)	
<b>Packaging</b>	3 kits per case	 Longitudinally Corrugated (LC) Shielded Cable

Order No.	UPC	Compatible with	5 kV (90 mil) AWG & kcmil	5/8 kV (115 mil) AWG & kcmil	8 kV (140 mil) AWG & kcmil	15 kV (175 mil) AWG & kcmil	15 kV (220 mil) AWG & kcmil	25/28 kV (260/280 mil) AWG & kcmil	35 kV (345 mil) AWG & kcmil
GSK-22	051128-53087	QT-II 5641	3/0-300	2/0-250	1/0-4/0	2-3/0	2-1/0	-	-
		QT-II 5651	3/0-300	2/0-250	1/0-4/0	2-3/0	2-1/0	2-1	-
		QT-III 7642-T-110	4/0-400	3/0-350	-	2-4/0	2-4/0	-	-
		QT-III 7642-S-2	4/0-400	3/0-350	-	2-4/0	2-4/0	-	-
		QT-III 7652-S-4	4/0-400	3/0-350	-	2-4/0	2-4/0	-	-
GSK-34	051128-53088	QT-II 5642	350-750	300-750	250-600	3/0-500	2/0-350	-	-
		QT-II 5652	350-750	300-750	250-600	3/0-500	2/0-350	1/0-250	-
		QT-II 5646	350-750	300-750	250-600	3/0-500	2/0-350	1/0-250	2-3/0
		QT-III 7653-S-4	300-500	250-500	4/0-350	2/0-300	2/0-300	2-4/0	-
		QT-III 7654-S-4	500-750	350-700	250-500	4/0-500	4/0-500	2/0-250	-
		QT-III 7644-T-110	500-750	350-700	250-500	4/0-500	4/0-500	-	-
		QT-III 7653-T-150	300-500	250-500	4/0-350	2/0-300	2/0-300	2-4/0	2-2/0
		QT-III 7663-S-8	300-500	250-500	4/0-350	2/0-300	2/0-300	2-4/0	2-2/0
QT-III 7664-S-8	500-750	350-700	250-500	4/0-500	4/0-500	2/0-250	2-4/0		
GSK-56	051128-53089	QT-II 5643	750-1500	750-1250	600-1000	500-1000	350-500	-	-
		QT-II 5644	1000-2000	1000-2000	800-1750	750-1750	600-1500	-	-
		QT-II 5653	750-1500	750-1250	600-1000	500-1000	350-500	300-500	-
		QT-II 5654	1000-2000	1000-2000	800-1750	750-1750	600-1500	600-1250	-
		QT-II 5647	750-1500	750-1250	600-1000	500-1000	350-500	300-500	4/0-400
		QT-II 5648	1000-2000	1000-2000	800-1750	750-1750	600-1500	600-1250	500-1000
		QT-III 7655-S-4	700-1500	600-1250	500-1000	500-1000	500-1000	250-800	-
		QT-III 7656-S-4	1750-2000	1500-2000	1250-1750	1250-2000	1250-2000	900-1750	-
		QT-III 7645-T-110	700-1500	600-1250	500-1000	500-1000	500-1000	-	-
		QT-III 7646-T-110	1750-2000	1500-2000	1250-1750	1250-2000	1250-2000	-	-
		QT-III 7655-T-150	700-1500	600-1250	500-1000	500-1000	500-1000	250-800	3/0-600
		QT-III 7656-T-150	1750-2000	1500-2000	1250-1750	1250-2000	1250-2000	900-1750	700-1500
		QT-III 7665-S-8	700-1500	600-1250	500-1000	500-1000	500-1000	250-800	3/0-600
		QT-III 7666-S-8	1750-2000	1500-2000	1250-1750	1250-2000	1250-2000	900-1750	700-1500

## Sealing and Grounding Kits

## 3M™ Hi-Amp Splice Grounding Accessory Kits SG-2 and SG-3

3M™ Hi-Amp Splice Grounding Accessory Kits SG-2 and SG-3 are designed to accommodate the shielding and grounding of inline splices made on longitudinally corrugated (LC) shield, heavy-duty tape and conventional tape-shielded power cables. The SG-2 and SG-3 designs provide a fault current capacity of 15,000 Amps for 15 cycles on 15 kV, 25 kV and 35 kV class cables. The 3M kits SG-2 and SG-3 were designed to accommodate 3M™ QS bodies as well as most other rubber-molded inline splices currently used in the electrical power distribution industry.

The 3M Copper Screen Sleeves SG-2 and SG-3 are applied over molded rubber splices on cables with shield diameters ranging from 1.25"-2.25" (31,8-57,2 mm). In most cases this will include conductor sizes between 350-1000 kcmil and voltage classes of 15-35 kV. The 3M copper screen sleeves SG-2 and SG-3 and the preformed ground connection braid have a capacity greater than that of 4 AWG copper wire and are fault current rated at 15,000 amps for 15 cycles. The 3M Kit SG-3 has a larger CMA (greater than 2 AWG) copper screen sleeve and two constant force springs per end. This provides additional neutral current capacity.

Each kit provides shielding and grounding for one splice.

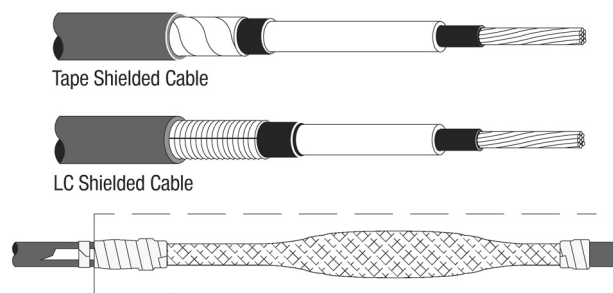

**Voltage** 15–35 kV

**Cable/Shielding Type** Tape Shield, Longitudinally Corrugated (LC)

Order No.	UPC	Shield O.D. Range	Conductor Size Range	Circular Mil Area	Kits per Case
SG-2	054007-50041	1.25"-2.25" (31,8-57,2 mm)	350-1000 kcmil	61,000	10
SG-3	054007-41511	1.25"-2.25" (31,8-57,2 mm)	350-1000 kcmil	72,000	10

## 3M™ Hi-Amp Accessory Grounding Kits 8473 and GSHA-8 QT-II

3M™ Hi-Amp Accessory Grounding Kits 8473 and GSHA-8 QT-II are both designed to accommodate the grounding of accessories installed on 15 kV, 25 kV and 35 kV Class longitudinally corrugated (LC), heavy-duty tape and conventional tape-shielded power cables.

The 8473 kit is a cold shrink design to be used with 600-Amp elbows and other accessories where cable jacket-to-accessory sealing and high-ampacity grounding is desired. Its preformed ground braid has a fault current capacity of 15,000 Amps for 15 cycles with an equivalent cross-sectional area greater than 4 AWG copper wire.

The GSHA-8 is designed to accommodate the grounding of terminations made on 15 kV, 25 kV and 35 kV Class longitudinally corrugated (LC), heavy-duty tape and conventional tape-shielded power cables. The 3M Kit GSHA-8 QT-II preformed ground braid design also provides a fault current capacity of 15,000 Amps for 15 cycles on 15–35 kV class cables.

Each kit provides grounding and/or sealing for one accessory or termination.

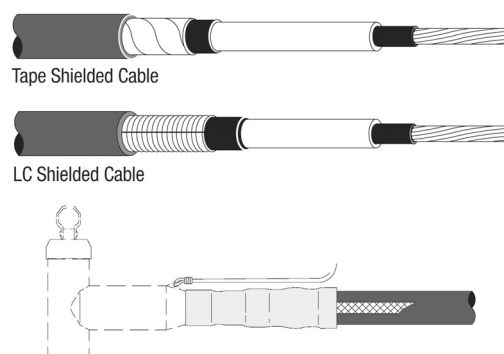

**Voltage** 15 kV, 25/28 kV, 35 kV

**Cable/Shielding Type** Tape Shield, Longitudinally Corrugated (LC)

Order No.	UPC	Shield O.D. Range	Conductor Size Range AWG and kcmil	Kits per Case
8473	054007-50043	1.25"-2.25" (31,8-57,2 mm)	350-1000 kcmil	10
GSHA-8	054007-50042	1.25"-2.25" (31,8-57,2 mm)	350-1000 kcmil	10

## Sealing and Grounding Kits

### 3M™ Cable Grounding Kits 2252, 2253 and 2254

The 3M™ Cable Grounding Kits 2252, 2253 and 2254 provide a simple, reliable and secure method for grounding and resealing of the jacket of direct buried distribution cables. These kits are designed for use with jacketed concentric neutral (JCN) power cables ranging from 2–4/0 AWG, rated through 35 kV. A common kit application is for grounding a primary neutral at least every 1320' (1/4 mile) per Rural Utilities Service (RUS) Bulletin 83-1.

Each kit provides enough material for one cable ground.



Jacketed Concentric Neutral Cable (JCN)

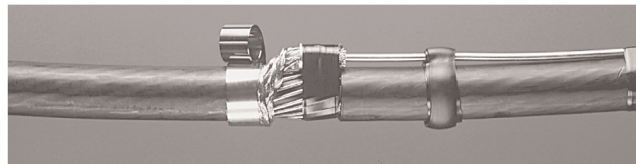

**Voltage** 35 kV  
**Cable/Shielding Type** Jacketed Concentric Neutral (JCN)

**Agency Approvals** 

Order No.	UPC	Conductor Size Range	Kits per Case
2252	054007-08335	2–4/0 AWG	10
2253	051128-55648	250–500 kcmil	10
2254	051128-56939	500–1000 kcmil	10

### 3M™ Cold Shrink Insertion Seal

Seals open space between a steel casing and plastic, gas, or utility pipe. Seal consists of EPDM rubber tubing that is expanded over a removable core and shrinks in diameter.



**Technology** Cold Shrink  
**Material** EPDM Rubber  
**RoHS 2011/65/EU** Yes

Order No.	UPC	Case Qty.
PS-2	054007-49886	10
PS-3	054007-50201	10
PS-4	054007-49887	10

## Splice Repair

## Lead Sheath Repair Kit

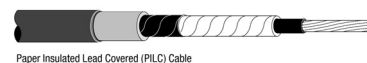

Paper Insulated Lead Covered (PILC) Cable

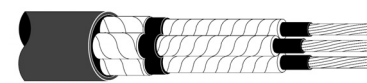

Three-Conductor Paper Insulated Lead Covered (PILC) Cable

Order No.	UPC	Description	Kits per Case
LEAD-SHEATH-REPAIR-KIT	054007-44246	For sealing oil leaks on PILC cable.	1

## Cable Breakout Boots and Phase Rejacketing System

## 3M™ Cold Shrink Silicone Rubber Cable Breakout Boots 8560 Series

3M™ Cold Shrink Silicone Rubber Cable Breakout Boots 8560 Series are a series of open-ended molded rubber sealing assemblies that are factory expanded and mounted on removable inner supporting plastic cores. They are supplied for field installation in a pre-stretched condition. The supporting cores are removed after the seal has been positioned for installation around the breakout area of a 3/C (three-conductor) cable. Core removal allows the silicone rubber boot to shrink down to a pre-determined diameter, creating an environmental enclosure for individual cable phase legs and the overall cable jacket.

3M™ Cold Shrink Silicone Rubber Cable Breakout Boots 8560 Series are designed to protect the phase leg breakout area of 3/C medium voltage shielded power cable from exposure to moisture, contamination, corrosion, ozone, ultra-violet radiation, physical contact and other hazards associated with 3/C termination operating environments.

The 8560 Series Breakout Boots can be used in conjunction with 3M™ Cold Shrink Silicone Rubber Termination Assemblies and 3M™ RJS Series Rejacketing Sleeves for 3/C shielded power cable terminating applications.

Voltage	35 kV and less
Number of Conductors	Three Conductors
Cable/Shielding Type	Shielded Power Cable
Color	Dark Gray
RoHS 2011/65/EU	Yes



Order No.	UPC	Cable Phase Shield Diameter Range	Cable Outer Jacket Diameter Range	Case Qty.
8561	054007-43143	0.48"–0.72" (12,2–18,3 mm)	1.30"–1.94" (33,0–49,3 mm)	1
8562	054007-43144	0.61"–0.95" (15,5–24,1 mm)	1.46"–2.67" (37,1–67,8 mm)	1
8563	054007-43145	0.82"–1.18" (20,8–30,0 mm)	1.92"–3.10" (48,8–78,7 mm)	1
8564	054007-43146	1.02"–1.63" (25,9–41,4 mm)	2.52"–4.32" (64,0–109,7 mm)	1
8565	054007-43147	1.09"–1.94" (27,7–49,3 mm)	2.60"–4.70" (66,0–119,4 mm)	1
8566	051128-58283	1.23"–2.17" (31,2–55,1 mm)	3.18"–5.52" (80,7–140,2 mm)	1

## Cable Breakout Boots and Phase Rejacketing System

### 3M™ RJS Series Rejacketing Sleeves

The 3M™ RJS Series Rejacketing Sleeves are designed so that 3M™ Cold Shrink QT-III and QT-III Silicone Rubber Terminations can be used on three-conductor (3/C) medium voltage shielded power cables of tape shield, wire shield, armored and non-armored configurations.

The RJS Series rejacketing assemblies are a series of silicone rubber insulators incorporating an inner-expandable polyester braid designed to reduce sliding friction and deliver the insulator onto the cable. Rejacketing sleeves are designed to protect the phase legs (core) of 3/C shielded power cable from exposure to moisture, corrosion, ozone, ultra-violet radiation, physical contact and other hazards associated with termination operating environments.

Rejacketing sleeves are designed to be used in conjunction with 3M™ Cold Shrink Breakout Boots and Silicone Rubber Terminations.



**Voltage 35 kV and less**

**Number of Conductors Three Conductors**

**Cable/Shielding Type Tape Shield, Wire Shield**

**RoHS 2011/65/EU Yes**

	RJS-1-4FT	RJS-1-10FT	RJS-2-4FT	RJS-2-10FT
UPC	054007-43098	054007-43099	054007-43100	054007-43101
Length	4' (1,22 m)	10' (3,05 m)	4' (1,22 m)	10' (3,05 m)
Metallic Shield Diameter Range	0.43"-0.60" (10,9-15,2 mm)	0.43"-0.60" (10,9-15,2 mm)	0.60"-0.80" (15,2-20,3 mm)	0.60"-0.80" (15,2-20,3 mm)
Conductor Size 3.3 kV - IEC	16-35 mm <sup>2</sup>	16-35 mm <sup>2</sup>	50-95 mm <sup>2</sup>	50-95 mm <sup>2</sup>
Conductor Size 3.3 kV - JIS	8-22 mm <sup>2</sup>	8-22 mm <sup>2</sup>	38-60 mm <sup>2</sup>	38-60 mm <sup>2</sup>
Conductor Size 5.0 kV - AEIC	8-2 AWG	8-2 AWG	1-3/0 AWG	1-3/0 AWG
Conductor Size 6.6 kV - JIS	16-25 mm <sup>2</sup>	16-25 mm <sup>2</sup>	35-70 mm <sup>2</sup>	35-70 mm <sup>2</sup>
Conductor Size 6.6 kV - IEC	8-10 mm <sup>2</sup>	8-10 mm <sup>2</sup>	14-38 mm <sup>2</sup>	14-38 mm <sup>2</sup>
Conductor Size 8.0 kV - AEIC	6-4 AWG	6-4 AWG	2-2/0 AWG	2-2/0 AWG
Conductor Size 10 kV - IEC	-	-	10-50 mm <sup>2</sup>	10-50 mm <sup>2</sup>
Conductor Size 15 kV - AEIC	-	-	2-1 AWG	2-1 AWG
Conductor Size 20 kV - IEC	-	-	-	-
Conductor Size 25 kV - AEIC	-	-	-	-
Conductor Size 30 kV - IEC	-	-	-	-
Conductor Size 35 kV - AEIC	-	-	-	-
Sleeves per Case	10	1	10	1
	RJS-3-4FT	RJS-3-10FT	RJS-4-4FT	RJS-4-10FT
UPC	054007-43102	054007-43103	054007-43104	054007-43105
Length	4' (1,22 m)	10' (3,05 m)	4' (1,22 m)	10' (3,05 m)
Metallic Shield Diameter Range	0.80"-1.02" (20,3-25,9 mm)	0.80"-1.02" (20,3-25,9 mm)	1.02"-1.28" (25,9-32,5 mm)	1.02"-1.28" (25,9-32,5 mm)
Conductor Size 3.3 kV - IEC	120-185 mm <sup>2</sup>	120-185 mm <sup>2</sup>	240-300 mm <sup>2</sup>	240-300 mm <sup>2</sup>
Conductor Size 3.3 kV - JIS	100-150 mm <sup>2</sup>	100-150 mm <sup>2</sup>	200-250 mm <sup>2</sup>	200-250 mm <sup>2</sup>
Conductor Size 5.0 kV - AEIC	4/0 AWG-400 kcmil	4/0 AWG-400 kcmil	500-750 kcmil	500-750 kcmil
Conductor Size 6.6 kV - JIS	95-150 mm <sup>2</sup>	95-150 mm <sup>2</sup>	185-300 mm <sup>2</sup>	185-300 mm <sup>2</sup>
Conductor Size 6.6 kV - IEC	60-100 mm <sup>2</sup>	60-100 mm <sup>2</sup>	150-250 mm <sup>2</sup>	150-250 mm <sup>2</sup>
Conductor Size 8.0 kV - AEIC	3/0 AWG-350 kcmil	3/0 AWG-350 kcmil	400-600 kcmil	400-600 kcmil
Conductor Size 10 kV - IEC	70-150 mm <sup>2</sup>	70-150 mm <sup>2</sup>	185-300 mm <sup>2</sup>	185-300 mm <sup>2</sup>
Conductor Size 15 kV - AEIC	1/0-4/0 AWG	1/0-4/0 AWG	250-450 kcmil	250-450 kcmil
Conductor Size 20 kV - IEC	25-70 mm <sup>2</sup>	25-70 mm <sup>2</sup>	95-185 mm <sup>2</sup>	95-185 mm <sup>2</sup>
Conductor Size 25 kV - AEIC	2-1/0 AWG	2-1/0 AWG	2/0 AWG-250 kcmil	2/0 AWG-250 kcmil
Conductor Size 30 kV - IEC	-	-	35-70 mm <sup>2</sup>	35-70 mm <sup>2</sup>
Conductor Size 35 kV - AEIC	-	-	1/0-3/0 AWG	1/0-3/0 AWG
Sleeves per Case	10	1	10	1



## 3M™ RJS Series Rejacketing Sleeves (continued)

	RJS-5-4FT	RJS-5-10FT	RJS-6-4FT	RJS-6-10FT
UPC	054007-43106	054007-43107	051128-54320	051128-54319
Length	4' (1,22 m)	10' (3,05 m)	4' (1,22 m)	10' (3,05 m)
Metallic Shield Diameter Range	1.28"-1.62" (32,5-41,1 mm)	1.28"-1.62" (32,5-41,1 mm)	1.62"-1.91" (41,1-48,5 mm)	1.62"-1.91" (41,1-48,5 mm)
Conductor Size 3.3 kV - IEC	-	-	-	-
Conductor Size 3.3 kV - JIS	300-325 mm <sup>2</sup>	300-325 mm <sup>2</sup>	-	-
Conductor Size 5.0 kV - AEIC	800-1000 kcmil	800-1000 kcmil	-	-
Conductor Size 6.6 kV - JIS	-	-	-	-
Conductor Size 6.6 kV - IEC	300-325 mm <sup>2</sup>	300-325 mm <sup>2</sup>	-	-
Conductor Size 8.0 kV - AEIC	750-1000 kcmil	750-1000 kcmil	-	-
Conductor Size 10 kV - IEC	-	-	-	-
Conductor Size 15 kV - AEIC	500-750 kcmil	500-750 kcmil	-	-
Conductor Size 20 kV - IEC	240-300 mm <sup>2</sup>	240-300 mm <sup>2</sup>	-	-
Conductor Size 25 kV - AEIC	300-500 kcmil	300-500 kcmil	-	-
Conductor Size 30 kV - IEC	95-240 mm <sup>2</sup>	95-240 mm <sup>2</sup>	-	-
Conductor Size 35 kV - AEIC	4/0 AWG-500 kcmil	4/0 AWG-500 kcmil	-	-
Sleeves per Case	10	1	1	1

### Sheath Seal Kits

## 3M™ Sheath Seal Kits 5831 and 5832

The 3M™ Sheath Seal Kits 5831 and 5832 are designed to seal the sheath area for multi-conductor cables with or without ground wires. These kits handle copper or aluminum cable from 2 AWG-500 kcmil (35-250 mm<sup>2</sup>). Each kit makes one seal.

Number of Conductors Multiple Conductor  
RoHS 2011/65/EU Yes

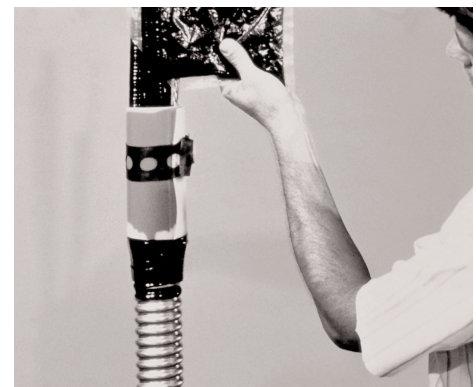

Order No.	UPC	Conductor Size	Maximum Jacket or Armor O.D.	Kits per Case
5831	051128-59173	2-3/0 AWG (35-80 mm <sup>2</sup> )	2.60" (66,0 mm)	1
5832	051128-59174	4/0 AWG-500 kcmil (120-250 mm <sup>2</sup> )	3.75" (95,3 mm)	1

## Sheath Seal Kits

### 3M™ Cold Shrink Sheath Seal Kits 5841 and 5842

The 3M™ Cold Shrink Sheath Seal Kits 5841 and 5842 are designed to seal the sheath area for three-conductor (3/C) cables without ground wires. They handle both copper and aluminum cables from 2AWG-500 kcmil (35-250 mm<sup>2</sup>). No heat is required when using these kits. Each kit makes one seal.

Number of Conductors Three Conductor  
RoHS 2011/65/EU Yes

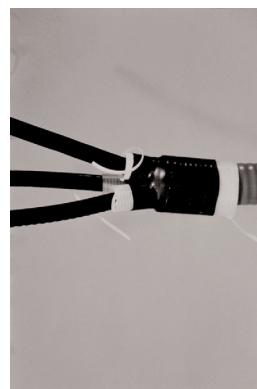

Order No.	UPC	Conductor Size	Conductor Insulation O.D.	Cable Jacket Range	Kits per Case
5841	054007-12291	2-4/0 AWG (35-100 mm <sup>2</sup> )	0.30"-1.18" (7,6-30,0 mm)	1.20"-1.90" (30,5-48,3 mm)	1
5842	054007-12292	4/0 AWG-500 kcmil (120-250 mm <sup>2</sup> )	0.77"-1.38" (19,6-35,1 mm)	1.80"-3.10" (45,7-78,7 mm)	1

## Electrical Resins

### 3M™ Scotchcast™ Electrical Insulating Resin 4

3M™ Scotchcast™ Electrical Insulating Resin 4 is a two-part epoxy insulating and encapsulating resin. This resin, mixed in its two-part closed mixing pouch, generates its own heat to cure. Its compatibility with solid and synthetic cable insulations and jackets makes Resin 4 an excellent insulator and sealer for cable splicing. Use 3M™ Scotchcast™ Electrical Insulating Resin 4 to splice solid dielectric and oil filled cables up to 8 kV and to jacket high voltage splices. It is included in the 3M™ Scotchcast™ Splice Kits 82-H Series, 82-B1, 85-14CP and 90-B1. Gel time is 16 min. at 23°C.

\*At 73°F (23°C) and cooler temperatures, resin will cure slower. Do not energize until resin has cooled and solidified.

Voltage	8 kV or less (for splicing solid dielectric and oil filled cables)
Cure Time	1 to 2 Hours at 70°F (21°C) 4 to 8 Hours at 50°F (10°C)
Energize Time	45 minutes*
Max. Operating Temperature	194°F (90°C) continuous
Color	Black
RoHS 2011/65/EU	Yes
Used in these kits	82-A Series; 82-B1; 85-14CP; 90-B1



Order No.	UPC	Packaging Description	Weight oz (g)	Volume in <sup>3</sup> (cm <sup>3</sup> )	Containers per Case
4A	054007-43165	2-part pouch	3.1 (88)	4.8 (78,6)	10
4B	054007-43166	2-part pouch	7.2 (205)	11.1 (181,9)	10
4C	054007-43167	2-part pouch	14.6 (414)	22.5 (368,7)	10
4D	054007-04206	2-part pouch	21.8 (619)	33.6 (550,6)	10
4E	054007-04207	2-part pouch	10.1 (288)	15.6 (255,6)	10

## Electrical Resins

## 3M™ Armorcast Structural Material 4560

3M™ Armorcast Structural Material 4560 is a flexible fiberglass knit fabric strip that has been saturated with a black urethane resin syrup. The material is rolled and packed dry in a sealed foil envelope. Armorcast structural material is completely safe for use in manholes, vaults, and other hazardous environments, because no heat source is required. No flames, electric heaters or chemicals are needed. The only thing your crews will ever have to add is water.

Material	Fiberglass
RoHS 2011/65/EU	Yes
Agency Approvals	RUS



Order No.	UPC	Color	Roll Size	Case Qty.
4560-5	051138-57719	Black	5 ft (1,52 m)	5
4560-10	051138-57717	Black	10 ft (3,05 m)	5
4560-15	051138-57718	Black	15 ft (4,57 m)	5

## 3M™ Scotchcast™ Electrical Insulating Resin 2104

3M™ Scotchcast™ Electrical Insulating Resin 2104 is a hard, two-part, polyurethane resin encapsulant designed specifically for permanent splice protection. Resin 2104 is formulated for virtually every electrical application requiring hard, non-reenterable resin with good handling and performance characteristics. Resin 2104 is also used as the insulating material for cable splices operating at 1000 volts or less and is rated for continuous use at 194°F (90°C) with an overload rating of 266°F (130°C). It may be stocked to cover all hard resin needs, ending the need for multiple encapsulant inventories.

Voltage	1000 Volts or less
Cure Time	1 Hour at 70°F (21°C) 20 Hours at 20°F (-4°C)
Energize Time	Immediately
Max. Operating Temperature	194°F (90°C) continuous
Color	Dark Green
RoHS 2011/65/EU	Yes
Used in these kits	72-N; 85 Series



Order No.	UPC	Packaging Description	Weight oz (g)	Volume in <sup>3</sup> (cm <sup>3</sup> )	Containers per Case
2104A	054007-31189	2-part pouch	3.46 (98)	5.7 (93,4)	10
2104B	054007-31382	2-part pouch	7.40 (210)	12.6 (206,4)	10
2104C	054007-31383	2-part pouch	14.82 (420)	25.4 (416,2)	10
2104D	054007-11849	2-part pouch	23.80 (675)	40.8 (668,5)	10
2104E	054007-31187	2-part pouch	10.6 (300)	19.1 (313,5)	10

## 3M™ Scotchcast™ Re-Enterable Electrical Insulating Resin 2123

3M™ Scotchcast™ Re-enterable Electrical Resin 2123 is a soft, two-part polybutadiene resin encapsulant designed especially for re-enterable splice protection. It is formulated for virtually every electrical application requiring a soft, re-enterable resin with good handling and performance characteristics. This resin is also used as the insulating material for cable splices operating at 1000 volts, and is rated for continuous use at 194°F (90°C) with an overload rating at 266°F (130°C). It may be stocked to cover most re-enterable resin needs, ending the need for multiple encapsulant inventories.

Scotchcast Resin 2123 is formulated with excellent wetting properties and low viscosity. The resin flows well even at low temperatures, filling the enclosure and minimizing voids. Scotchcast Resin 2123 is packaged in a convenient two-part closed mixing pouch.

<b>Voltage</b>	1000 Volts or less
<b>Cure Time</b>	24 Hours @70°F (21°C)
<b>Energize Time</b>	Immediately
<b>Max. Operating Temperature</b>	194°F (90°C) continuous
<b>Color</b>	Amber, Translucent
<b>RoHS 2011/65/EU</b>	Yes
<b>Used in these kits</b>	78-R Series



Order No.	UPC	Package Description	Weight, oz (g)	Volume, in <sup>3</sup> (cm <sup>3</sup> )	Containers per Case
2123C	051128-55120	2-part pouch	12.3 (350)	23.7 (338,3)	10
2123D	051128-55121	2-part pouch	21.2 (600)	40.6 (665,3)	10

## Electrical Resins

### 3M™ Scotchcast™ Flame-Retardant Compound 2131

3M™ Scotchcast™ Flame-Retardant Compound 2131 is a two-part polyurethane resin designed to replace the cable jacket when splicing or repairing mine and portable cables. Its unique formulation makes it particularly suited to withstand the rugged conditions under which mine and portable cables must operate. When used in accordance with the appropriate kit configuration, Compound 2131 conforms to MSHA Part 7, Title 30 CFR.

Flame-Retardant Compound 2131 is also used as the insulating material for cable splices operating at up to 1000 volts and designed for 194°F (90°C) at continuous use and for 266°F (130°C) at temporary, overload temperature.

3M™ Scotchcast™ Flame-Retardant Compound 2131 comes in two sizes of 2-part pouch containers, as well as separate 5 gallon jugs for both Part A and Part B. (Note: 2.1 parts of B required for every 1 part of A by weight.)

<b>Voltage</b>	1000 Volts or less
<b>Cure Time</b>	16 to 24 Hours at 70°F (21°C)
<b>Energize Time</b>	Immediately
<b>Max. Operating Temperature</b>	194°F (90°C) continuous
<b>Color</b>	Black
<b>RoHS 2011/65/EU</b>	Yes
<b>Used in these kits</b>	5750; 5760; 5831; 5832; 82-F1; 82-F2; 82-BF1; M-20; M-30; M-40



Order No.	UPC	Packaging Description	Weight	Volume in³ (cm³)	Case Qty.
2131B	051128-59166	2-part pouch	7.5 oz (213 g)	10.6 (175)	10
2131C	051128-59167	2-part pouch	21.5 oz (612 g)	30.6 (502)	10
2131-Part A 5 Gal	051128-59181	5 gallon jug, Part A	44.5 lb (20.1 kg)		1 pail
2131-Part B 5 Gal	051128-59182	5 gallon jug, Part B	46.5 lb (21 kg)		1 pail

## Electrical Resins

### 3M™ Scotchcast™ Potting Kit 2136

The 3M™ Scotchcast™ Potting Kit 2136 is designed to provide protection against corrosion and possible deteriorating effects of fresh swimming pool or fountain water and sunlight by reliably encapsulating the 8 AWG ground connection in a wet-niche shell as required by NEC® when using rigid, non-metallic conduit in the installation of wet-niche

underwater lighting fixtures. Scotchcast 2136 compound is UL Listed as a potting compound for swimming pool, fountain, or spa equipment and is for use only where adhering to copper, copper alloy and stainless steel materials.

3M™ Scotchcast™ Potting Compound 2136 is a thixotropic polyurethane resin, designed to resist dripping or sagging, and contained in an easy mix 1.5 oz. closed mixing pouch. At temperatures above 40°F (18°C) the compound will firm up in minutes. Encapsulated connections should be allowed to cure for 4 hours prior to submersion.

<b>Voltage</b>	Up to 1000 Volts; UL Listed up to 600 Volts
<b>Cure Time</b>	4 Hours at 70°F (21°C)
<b>Energize Time</b>	Immediately
<b>Max. Operating Temperature</b>	UL Listed 20L02 220°F (105°C)
<b>Color</b>	Black
<b>RoHS 2011/65/EU</b>	Yes



Order No.	UPC	Material	Weight, oz (g)	Containers per Case
2136	051128-59190	Potting Compound	1.50 (42,5)	10

### Resin Kit Accessories

Order No.	UPC	Product Name	Description	Items per Case
F-10	054007-09142	3M™ Funnel PE 2.75 Large M-Series F-10	Funnel used with M-series molds for resin re-jacketing or cable repair with 3M Scotchcast™ Resins 2130.	1
E-4	054007-25701	3M™ Resin Pressure Gun E-4	Reusable resin pressure gun used for constructing a resin pressure splice.	1



Cold Shrink Trifurcating Accessory Kit

## 3M™ Cold Shrink MT-C & MT-E Trifurcating Accessory Kits (One 3/C to Three 1/C) for 5/8 kV

3M™ Cold Shrink MT-C and MT-E Trifurcating Accessory Kits are used to break out and seal a transition from 3/C to three 1/C.

For use with 3M™ Cold Shrink QS-III Splicing Series 5700A-MT.

**NOTE: Cable sizes shown below are for standard insulation thickness. Final determining factor is cable insulation O.D.**

**Voltage:** 5/8 kV

**Number of Conductors:** One 3/C to three 1/C



### Selection Table

3M™ Splice 57XXA-MT	5/8 kV (90/140 mil)	Appropriate MT Transition Kit
*Typical Conductor Size Range – AWG/kcmil		
5775A-MT	3/0-250	MT-C
5776A-MT	350	MT-C
5776A-MT	500	MT-E
5777A-MT	—	MT-E

Order No.	UPC	Single Conductor Jacket O.D.	Kits per Case
MT-C	051128-55208	0.62"-1.13" (15,7-28,7 mm)	1
MT-E	051128-54318	1.13"-1.80" (28,7-45,7 mm)	1

## Cold Shrink Corrosion Protection Kits

### 3M™ Cold Shrink Corrosion Protection Kit CPT Series

3M™ Cold Shrink Corrosion Protection Kit CPT Series are designed to provide a quick and easy method for protecting bulkhead termination connectors from the corrosive influences of wet and salt-fog installation environments.

A CPT series assembly is an open-ended tubular rubber sleeve which is factory expanded and assembled onto a removable core. The core is removed after the assembly has been positioned for installation over a bulkhead terminator connector. Mastic strips are provided for sealing between NPT fitting threads and the enclosure in use (junction box, cabinet, panel board, etc.). CPT insulating sleeves are made of an EPDM rubber that contains no chlorides or sulfers.

RoHS 2011/65/EU Yes

Agency Approvals Meets salt spray requirements



Order No.	UPC	Min. Cable O.D.	Max. Connector O.D.	Max. Connector Installed Length	Kits per Case
CPT-1/2	054007-43021	0.50" (12,7 mm)	1.60" (40,6 mm)	4.50" (114 mm)	10
CPT-3/4	054007-43022	0.66" (16,8 mm)	1.90" (48,3 mm)	4.80" (122 mm)	10
CPT-1	054007-43023	0.66" (16,8 mm)	2.20" (55,9 mm)	4.80" (122 mm)	10
CPT-1-1/4	054007-43024	1.22" (31,0 mm)	2.65" (67,3 mm)	4.80" (122 mm)	10
CPT-1-1/2	054007-43025	1.40" (35,6 mm)	3.00" (76,2 mm)	5.50" (140 mm)	10
CPT-2	054007-43026	1.68" (42,7 mm)	3.60" (91,4 mm)	6.50" (165 mm)	10
CPT-2-1/2	054007-43027	1.97" (50,0 mm)	4.30" (109,2 mm)	8.50" (215 mm)	5
CPT-3	054007-43028	2.60" (66,0 mm)	5.40" (137,2 mm)	10.50" (266 mm)	5
CPT-3-1/2	054007-43029	2.90" (73,7 mm)	6.00" (152,4 mm)	13.50" (343 mm)	5
CPT-4	054007-43030	2.90" (73,7 mm)	6.00" (152,4 mm)	13.00" (330 mm)	5

## Cold Shrink End Caps

### 3M™ Cold Shrink End Caps EC-Series

3M™ Cold Shrink End Caps EC-Series are close-ended, tubular rubber sleeves that are factory expanded and loaded onto a removable core. When positioned over the end of a cable or other cylindrical object, the core is removed to provide a reliable environmental seal. Four different end caps are available to accommodate a wide range of sizes.

Color Black

RoHS 2011/65/EU Yes



Order No.	UPC	Use Range	Sleeves per Case
EC-1	051128-58388	0.46"–0.82" (11,6–20,9 mm)	10
EC-2	051128-58389	0.63"–1.18" (15,9–30,1 mm)	10
EC-3	051128-58390	1.02"–1.94" (26,0–49,3 mm)	10
EC-4	051128-58391	1.79"–3.32" (45,6–84,3 mm)	10

## Mounting Brackets

### 3M™ Cross-Arm Mounting Brackets MB-1

The 3M™ Cross-Arm Mounting Bracket MB-1 is a cross-arm bracket for use in holding terminated cable. The MB-1 is ideal to use when ordering the MB or MBS termination mounting brackets featured on this page.



Order No.	UPC	Compatible with	Brackets per Case
MB-1	054007-11230	3M™ Mounting Brackets MB and MBS Series	10 each

### 3M™ Mounting Brackets MB and MBS Series

The 3M™ Mounting Brackets MB and MBS Series have been designed to mount 3M™ Molded Rubber Terminations. The MB series brackets are made from galvanized steel, while the MBS series brackets are made from stainless steel to provide corrosion protection in highly contaminated environments. These brackets are attached to the cable just below the termination. This provides a tongue that can then be attached to an MB-1 mounting bracket or to any other support.

\* CAUTION: Use cable O.D., not insulation O.D. for determining the proper size.

\*\* Has double-clamps.

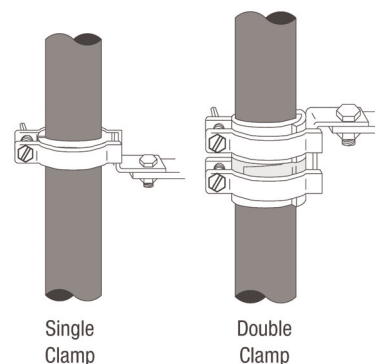

Order No.	UPC	Cable O.D. Range	Brackets per Case
MB-3	054007-14754	0.80"–1.25" (20,3–31,8 mm)	10 each
MB-4	054007-14755	1.10"–1.50" (27,9–38,1 mm)	10 each
MB-5**	054007-08200	1.45"–1.95" (36,8–49,5 mm)	10 each
MB-6**	054007-08286	1.80"–2.40" (45,7–61,0 mm)	10 each
MBS-4**	054007-49685	1.10"–1.70" (27,9–43,2 mm)	10 each
MBS-5**	054007-49686	1.45"–1.95" (36,8–49,5 mm)	10 each
MBS-6**	054007-49687	1.80"–2.40" (45,7–61,0 mm)	10 each

## Preparation and Cleaning

### 3M™ Scotch-Brite™ Hand Pads 7440 Series

3M™ Scotch-Brite™ Hand Pads 7440 Series make the toughest cleaning jobs easier. They resist tearing, splintering, shredding and loading and will never rust. Blending pads are made of a coarse mineral abrasive. General Purpose Pads are reusable—they rinse clean and are constructed of a nylon web. Ultra Fine Pads are highly conformable. 3M Scotch-Brite Hand Pads measure 6" x 9" (152 x 228 mm).

Select the 3M Scotch-Brite Hand Pads for your specific abrasion needs and carry them with you everywhere you work. You can use them on virtually any surface material, including all kinds of metals, plastics, composites, ceramics, porcelain, glass and rubber.



	7446	7447	7448
UPC	048011-04051	048011-04029	048011-04028
Description	Open, aggressive web that is excellent to grain, clean, denib, defuzz and finish. Resistant to loading. May be used by hand, on a hand pad block, or on an in-line sander.	Most universally used in a variety of applications. Excellent starting point to clean, finish, grain, denib and defuzz. May be used by hand, with a hand pad block, or on an in-line sander.	Conformable web and finest silicon carbide hand pad available. Excellent for final finishing and light cleaning. May be used by hand, with a hand block, or on an in-line sander.
Abrasive Mineral Type	Silicon Carbide	Aluminum Oxide	Silicon Carbide
Grade	Medium	Very Fine	Ultra Fine
Color	Gray	Maroon	Light Gray
Length	9" (228,6 mm)	9" (228,6 mm)	9" (228,6 mm)
Width	6" (152,4 mm)	6" (152,4 mm)	6" (152,4 mm)
Pads per Box	10	20	20
Boxes per Case	4	3	3

### 3M™ Cable Cleaning System CC Series

3M™ Cable Cleaning System CC Series cleans cable insulation, metal, electrical and mechanical parts. It can be used for PCB cleanup and in parts cleaners for degreasing.

CC-Dry contains three each 4" x 8" (102 x 203 mm) lintless non-woven pads packed in a bag. These are used for drying the common citrus cable cleaner (CC series) off of cable installation when preparing cable. The CC-2-Dry Kit contains a CC-2 Kit and three each dry lintless pads.

RoHS 2011/65/EU Yes



Order No.	UPC	Description	Kit Contents	Kits per Case
CC-2	054007-49563	Cable preparation kit	(3) Saturated cable cleaning pads and (1) Non-conductive grit abrasive cloth	10
CC-DRY	054007-43415	Dry wiping cloth	(3) Unsaturated cable cleaning pads	10
CC-2-DRY	054007-43414	Dry cable preparation kit	(3) Unsaturated cable cleaning pads and (1) Non-conductive grit abrasive cloth	10
CC-3	054007-49564	Cable cleaning pad	(3) Saturated cable cleaning pads	10

## Preparation and Cleaning

## 3M™ Scotch® Electricians' Abrasive Roll A-3

Scotch® Electricians' Abrasive Roll A-3 is a 120-grit, closed-coat aluminum oxide strip, which is nonconductive and flexible. It is packaged in a dispenser-type box.

Abrasive Mineral Type	Aluminum Oxide
Abrasive Backing Weight	J Weight
Abrasive Backing Type	Cloth



Order No.	UPC	Length	Width	Grade	Product Form	Rolls per Case
A-3	054007-11560	75' (22,86 m)	1" (25,4 mm)	120	Roll	10

## 3M™ Wraparound Heat Shrink Cable Repair HDCW Sleeves

### 3M™ Heat Shrink Wraparound Cable Repair Wrap Sleeve HDCW

3M™ Heat Shrink Wraparound Cable Repair Wrap Sleeves HDCW are designed to quickly repair damaged cable jacketing. They may also be used to re-jacket in-line splices. HDCW wrap sleeves can be used as insulation material on cable and splices up to 1000 volts and as jacket repair material on cable up to 35 kV. The design of the wrap sleeve allows it to be installed in tight spaces with ordinary heating equipment such as a torch.

HDCW wrap sleeves are made from modified cross-linked polyolefin, with a hot-melt adhesive liner on the inner side of the sleeve. Upon heating, the sleeve shrinks and the adhesive melts, creating a water-tight bond between the sleeve and the cable. 3M Heat Shrink Wraparound Cable Repair Wrap Sleeves HDCW meet ANSI C119.1 requirements. A corrosion proof metal channel is used to close the sleeve during installation.

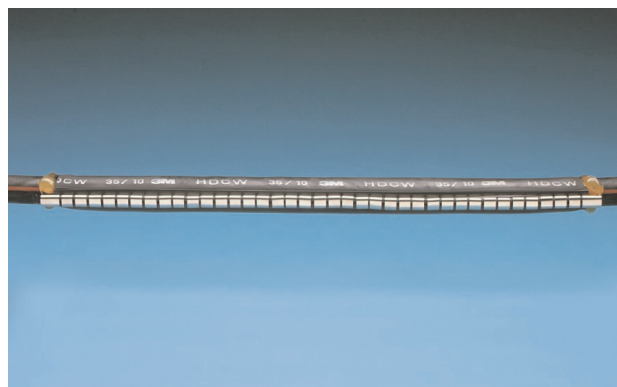

Voltage	1000 Volts Max.
Material	Adhesive-lined, Cross-Linked Polyolefin
RoHS 2011/65/EU	Yes

Order No.	UPC	Cable Size	Sleeve Length	Jacket Repair Use Range	Expanded/Recovered Diameter	Case Qty.
HDCW-35/10-250	051138-48416	8-2/0 AWG	9.8" (250 mm)	1.38"-0.39" (35-10 mm)	1.97"/0.32" (50/8 mm)	5
HDCW-35/10-500	051138-48417	8-2/0 AWG	19.7" (500 mm)	1.38"-0.39" (35-10 mm)	1.97"/0.32" (50/8 mm)	5
HDCW-35/10-750	051138-48418	8-2/0 AWG	29.5" (750 mm)	1.38"-0.39" (35-10 mm)	1.97"/0.32" (50/8 mm)	5
HDCW-35/10-1000	051138-48419	8-2/0 AWG	39.4" (1000 mm)	1.38"-0.39" (35-10 mm)	1.97"/0.32" (50/8 mm)	5
HDCW-35/10-1200	051138-48436	8-2/0 AWG	47.2" (1200 mm)	1.38"-0.39" (35-10 mm)	1.97"/0.32" (50/8 mm)	5
HDCW-55/15-250	051138-48420	3/0 AWG-400 kcmil	9.8" (250 mm)	2.17"-0.59" (55-15 mm)	2.95"/.51" (75/13 mm)	5
HDCW-55/15-500	051138-48421	3/0 AWG-400 kcmil	19.7" (500 mm)	2.17"-0.59" (55-15 mm)	2.95"/.51" (75/13 mm)	5
HDCW-55/15-750	051138-48422	3/0 AWG-400 kcmil	29.5" (750 mm)	2.17"-0.59" (55-15 mm)	2.95"/.51" (75/13 mm)	5
HDCW-55/15-1000	051138-48423	3/0 AWG-400 kcmil	39.4" (1000 mm)	2.17"-0.59" (55-15 mm)	2.95"/.51" (75/13 mm)	5

## 3M™ Wraparound Heat Shrink Cable Repair HDCW Sleeves

### 3M™ Heat Shrink Wraparound Cable Repair Wrap Sleeve HDCW (continued)

Order No.	UPC	Cable Size	Sleeve Length	Jacket Repair Use Range	Expanded/Recovered Diameter	Case Qty.
HDCW-55/15-1200	051138-48437	3/0 AWG-400 kcmil	47.2" (1200 mm)	2.17"-0.59" (55-15 mm)	2.95"/.51" (75/13 mm)	5
HDCW-80/25-250	051138-48424	500-1000 kcmil	9.8" (250 mm)	3.15"-0.98" (80-25 mm)	3.94"/0.91" (100/23 mm)	5
HDCW-80/25-500	051138-48425	500-1000 kcmil	19.7" (500 mm)	3.15"-0.98" (80-25 mm)	3.94"/0.91" (100/23 mm)	5
HDCW-80/25-750	051138-48426	500-1000 kcmil	29.5" (750 mm)	3.15"-0.98" (80-25 mm)	3.94"/0.91" (100/23 mm)	5
HDCW-80/25-1000	051138-48427	500-1000 kcmil	39.4" (1000 mm)	3.15"-0.98" (80-25 mm)	3.94"/0.91" (100/23 mm)	5
HDCW-80/25-1200	051138-48438	500-1000 kcmil	47.2" (1200 mm)	3.15"-0.98" (80-25 mm)	3.94"/0.91" (100/23 mm)	5
HDCW-110/30-500	051138-48429	1000-2000 kcmil	19.7" (500 mm)	4.33"-1.18" (110-30 mm)	5.20"/0.98" (132/25 mm)	5
HDCW-110/30-750	051138-48430	1000-2000 kcmil	29.5" (750 mm)	4.33"-1.18" (110-30 mm)	5.20"/0.98" (132/25 mm)	5
HDCW-110/30-1000	051138-48431	1000-2000 kcmil	39.4" (1000 mm)	4.33"-1.18" (110-30 mm)	5.20"/0.98" (132/25 mm)	5
HDCW-110/30-1200	051138-48439	1000-2000 kcmil	47.2" (1200 mm)	4.33"-1.18" (110-30 mm)	5.20"/0.98" (132/25 mm)	5
HDCW-140/40-1000	051138-48435	N/A	39.4" (1000 mm)	5.51"-1.57" (140-40 mm)	5.71"/1.26" (145/32 mm)	5
HDCW-140/40-1200	051138-48440	N/A	47.2" (1200 mm)	5.51"-1.57" (140-40 mm)	5.71"/1.26" (145/32 mm)	5



# Splice Jacketing, Rejacketing and Cable Repair, For 15–35 kV Cables and Splices

The following 3M products cover splicing needs for applications 15-35 kV, and promote dependable performance, stability and long life with every splice you make.

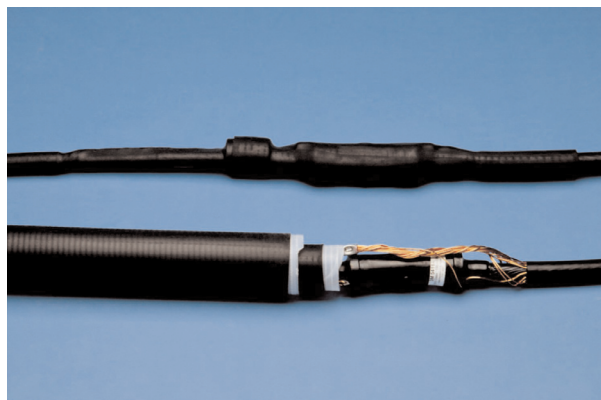

Section	Page
Splice Jacketing, Rejacketing and Cable Repair .....	359-364
3M™ Splice Jacketing and Rejacketing Kits.....	360-364
3M™ Cold Shrink Foldback Splice Jacket Kits.....	360
3M™ Cold Shrink Splice Jacket Kits .....	361
3M™ Cold Shrink Stacked Sleeve Splice Jacket Kits.....	362
3M™ Heat Shrinkable Splice Jacket Kits HSJ Series.....	363
3M™ Scotchcast™ Jacket Repair Kits M Series (up to 2 kV) .....	364

## 3M™ Cold Shrink Foldback Splice Jacket Kits

3M™ Cold Shrink Foldback Splice Jacket Kits SJ-FB Series are a series of folded back, tubular, rubber sleeves that, combined with Scotch® Rubber Mastic Tape 2228, provide a sealed jacket over cable splices installed on jacketed power cable. The Scotch® Rubber Mastic Tape 2228 helps assure a seal between the cable jacket and cold shrink foldback jacket tube. Mastic strips are also used to seal around the optional, external ground conductor. The cold shrink jacket tube is provided in an expanded state, mounted on two inner supporting cores. As supplied in this pre-stretched condition, the tube is ready for field installation. The jacketing tube is made from EPDM rubber that contains no chlorides or sulfurs. The completed jacket tube will be continuous from cable jacket to cable jacket, with no seams. Four kit sizes cover an application range from 4 AWG, 15 kV to sizes larger than 4/0 AWG, 35 kV.

Each kit contains sufficient materials to jacket one cable splice.

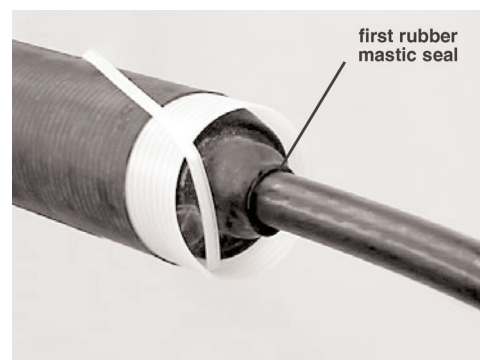

<b>Voltage</b>	15–35 kV
<b>Number of Conductors</b>	Single Conductor
<b>RoHS 2011/65/EU</b>	Yes

Order No.	UPC	Min. Cable Jacket O.D.	Max. Splice O.D.	Max. Cable Jacket Opening	Application Parking Space Required	Compatible With	Kits per Case
SJ-1FB	051128-55302	0.95" (24,1 mm)	2.00" (50,8 mm)	25.0" (635 mm)	20.0" (510 mm)	15 kV: 3M™ Splice No. 5411, 5411A, and 5412	6
SJ-2FB	051128-55303	1.15" (29,2 mm)	3.00" (76,2 mm)	31.0" (787,4 mm)	22.0" (560 mm)	15 kV: 3M™ Splice No. 5403, 5404, 5405, and 5406 25 kV: 3M™ Splice No. 5420, 5421, 5422, 5451, 5451A, and 5452 35 kV: 3M™ Splice No. 5432 and 5461	6
SJ-3FB	051128-55304	1.55" (39,4 mm)	3.62" (91,9 mm)	34.0" (863,6 mm)	24.0" (610 mm)	15 kV: 3M™ Splice No. 5407, 5408, and 5409 25 kV: 3M™ Splice No. 5423, 5424, 5425, and 5426 35 kV: 3M™ Splice No. 5433	6
SJ-4FB	051128-55305	1.75" (44,5 mm)	4.10" (104,1 mm)	32.0" (812,8 mm)	24.0" (610 mm)	-	6

## 3M™ Cold Shrink Splice Jacket Kits

3M™ Cold Shrink Splice Jacket Kits SJ Series are a series of open ended, tubular, rubber sleeves that combined with Scotch® Rubber Mastic Tape 2228 provide a sealed jacket over cable splices installed on jacketed power cable. The Scotch® Rubber Mastic Tape 2228 helps assure a seal between the cable jacket and the cold shrink jacket tube. It is also used to seal around a cable ground conductor. The cold shrink jacket tube is provided in an expanded state, mounted on two inner supporting plastic cores. As supplied in this prestretched condition, the tube is ready for field installation. The jacketing tube is made of EPDM rubber which contains no chlorides or sulfurs. Three kit sizes cover an application range of 0.95"-4.00" (24-102 mm).



**Voltage** 15–35 kV

**Number of Conductors** Single Conductor

**RoHS 2011/65/EU** Yes

Order No.	UPC	Application Parking Length	Application Installed Length	Min. Cable Jacket O.D.	Max. Splice O.D.	Max. Cable Jacket Opening	Compatible With	Kits per Case
SJ-1A	054007-69742	29.0" (737 mm)	23.0"-27.0" (584,2-685,8 mm)	0.95" (24,1 mm)	2.4" (61,0 mm)	20.0" (508 mm)	15 kV: 3M™ Splice No. 5411, 5411A, 5412, 5411R	6
SJ-2A	054007-69743	36.0" (914 mm)	32.0"-35.0" (813-889 mm)	1.15" (29,2 mm)	3.3" (83,8 mm)	28.0" (711 mm)	15 kV: 3M™ Splice No. 5403, 5404, 5405, and 5406 25 kV: 3M™ Splice No. 5420, 5421, 5422, 5451, and 5452 35 kV: 3M™ Splice No. 5432 and 5461	6
SJ-3A	054007-69744	38.0" (965 mm)	33.0"-37.0" (83,82-93,98 cm)	1.55" (39,4 mm)	4.0" (101,6 mm)	30.0" (762,0 mm)	15 kV: 3M™ Splice No. 5407, 5408, and 5409 25 kV: 3M™ Splice No. 5423, 5424, 5425, and 5426 35 kV: 3M™ Splice No. 5433	6

## 3M™ Cold Shrink Stacked Sleeve Splice Jacket Kits

3M™ Cold Shrink Stacked Sleeve Splice Jacket Kits SJ-SS Series are a series of open ended, tubular rubber sleeves that, combined with Scotch® Rubber Mastic Tape 2228 and a profile bushing, provide a sealed jacket over cable splices installed on jacketed power cable. The Scotch® Rubber Mastic Tape 2228 provides a seal between the cable jacket and cold shrink jacket tube. Mastic strips are also used to seal around an optional, external ground conductor. The cold shrink jacket tubes are provided in an expanded state, mounted on inner supporting plastic cores. As supplied in this prestretched condition, the tubes are ready for field installation. The jacketing tubes are made of EPDM rubber which contains no chlorides or sulfurs. Three kit sizes cover an application range of 0.95"–3.62" (24,1–92,0 mm).

Each kit jackets one cable splice.

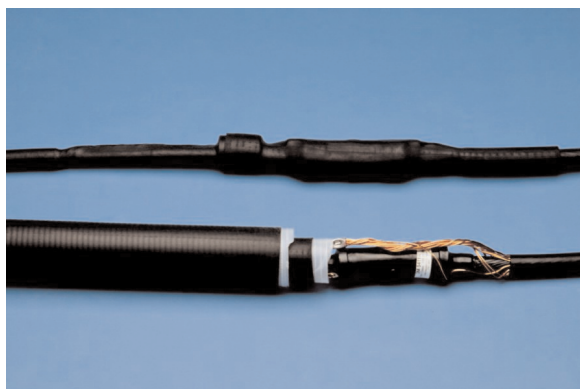

<b>Voltage</b>	15–35 kV
<b>Number of Conductors</b>	Single Conductor
<b>RoHS 2011/65/EU</b>	Yes

Order No.	UPC	Min. Cable Jacket O.D.	Max. Splice O.D.	Max. Cable Jacket Opening	Parking Space Required (approximate)	Compatible With	Kits per Case
SJ-1SS	054007-50777	0.95" (24,1 mm)	1.95" (49,5 mm)	23.0" (584 mm)	19.0" (483 mm)	15 kV: 3M™ Splice No 5411, 5411A, and 5412	6
SJ-2SS	054007-50778	1.15" (29,2 mm)	3.00" (76,2 mm)	31.0" (787 mm)	25.0" (635 mm)	15 kV: 3M™ Splice No. 5403, 5404, 5405, and 5406 25 kV: 3M™ Splice No. 5420, 5421, 5422, 5451, 5451A, and 5452 35 kV: 3M™ Splice No. 5432 and 5461	6
SJ-3SS	054007-50779	1.55" (39,4 mm)	3.62" (92,0 mm)	35.0" (889 mm)	26.0" (660 mm)	15 kV: 3M™ Splice No. 5407, 5408, and 5409 25 kV: 3M™ Splice No. 5423, 5424, 5425, and 5426 35 kV: 3M™ Splice No. 5433	6
SJ-1SSR	054007-41956	0.95" (24,1 mm)	1.95" (49,5 mm)	29.0" (737 mm)	25.0" (635 mm)	15 kV: 3M™ Splice No. 5411R	6
SJ-2SSR	054007-41957	1.15" (29,2 mm)	3.00" (76,2 mm)	37.0" (940 mm)	31.0" (787 mm)	15 kV: 3M™ Splice No. 5412R 25/28 kV: 3M™ Splice No. 5451R	6

## Splice Jacketing, Rejacketing and Cable Repair: 3M™ Splice Jacketing and Rejacketing Kits

### 3M™ Heat Shrinkable Splice Jacket Kits HSJ Series

3M™ Heat Shrinkable Splice Jacket Kits HSJ Series are designed to jacket power cable splices installed on jacketed power cable. The sleeves physically cover the cable neutral wires to environmentally protect the cable at the splice location. Fabricated from medium wall cross-linked polyolefin, the sleeves are flexible, highly split resistant and fast shrinking to provide rapid installation. The sleeves come with a factory applied adhesive/sealant. Sleeves are supplied in black only.

**Voltage** 15–35 kV  
**Number of Conductors** Single Conductor



Order No.	UPC	Sleeve Length	Expanded Sleeve I.D.	Min. Cable Jacket Diameter	Max. Splice Diameter	Max. Cable Jacket Opening	Compatible With	Kits per Case
HSJ-1	054007-09270	33.0" (838,2 mm)	2.50" (64 mm)	0.85" (22 mm)	1.90" (48,3 mm)	22.0" (559 mm)	15 kV: 3M™ Splice No 5411, 5411A and 5412	10
HSJ-2	054007-09271	40.0" (1016 mm)	3.00" (76,2 mm)	1.00" (25,4 mm)	2.60" (66,0 mm)	28.0" (711,2 mm)	15 kV: 3M™ Splice No. 5403, 5404, 5405, and 5406 25 kV: 3M™ Splice No. 5420, 5421, 5422, 5451, 5451A, 5452, and 5451R 35 kV: 3M™ Splice No. 5432 and 5461	10
HSJ-3	054007-09272	40.0" (1016 mm)	4.30" (109,2 mm)	1.50" (38,1 mm)	3.40" (86,4 mm)	28.0" (711,2 mm)	15 kV: 3M™ Splice No. 5407, 5408, and 5409 25 kV: 3M™ Splice No. 5423, 5424, 5425, and 5426 35 kV: 3M™ Splice No. 5433	5

## 3M™ Scotchcast™ Jacket Repair Kits M Series (up to 2 kV)

3M™ Scotchcast™ Jacket Repair Kits M Series contain a reusable wrap-around mold and accessory materials needed to make 10 permanent, flexible and moisture-resistant jacket repairs or splices of portable cable. The kit contains a wrap around mold that permits jacket repair without cutting through the cable. The M series kits, when used with 3M™ Scotchcast™ Flame-Retardant Compound 2131, provide durable, flexible jacket repair. Scotchcast kits can be used with portable power cable or standard cable.

Note: Scotchcast Flame-Retardant Compound 2131 needed to jacket the repair or splice is not included and must be ordered separately. U.S. Mine Safety and Health Administration acceptance No. 07-KA060007-MSHA.

<b>Voltage</b>	Up to 2 kV
<b>Cable/Shielding Type</b>	Shielded and Non-Shielded
<b>Splice Type</b>	Jacket Repair
<b>RoHS 2011/65/EU</b>	Yes
<b>Agency Approval</b>	07-KA060007-MSHA approved when used with Scotchcast Compound 2131.



Order No.	UPC	Cable O.D.	Max. Repair Length	Case Qty.
M-20	051128-59223	1.60"-2.50" (41-63 mm)	13.0"-15" (330-381 mm)	1
M-30	051128-59224	1.85"-4.00" (47-102 mm)	20.0" (508 mm)	1
M-40	051128-59225	1.85"-6.00" (47-152 mm)	32.0" (813 mm)	1



# Cable Accessory Products

3M offers accessory products to assist with splice re-jacketing, cable jacket sealing, grounding and cable preparation. Many of the products shown here are used with 3M splices and terminations. Remember to reference those sections for more product information.

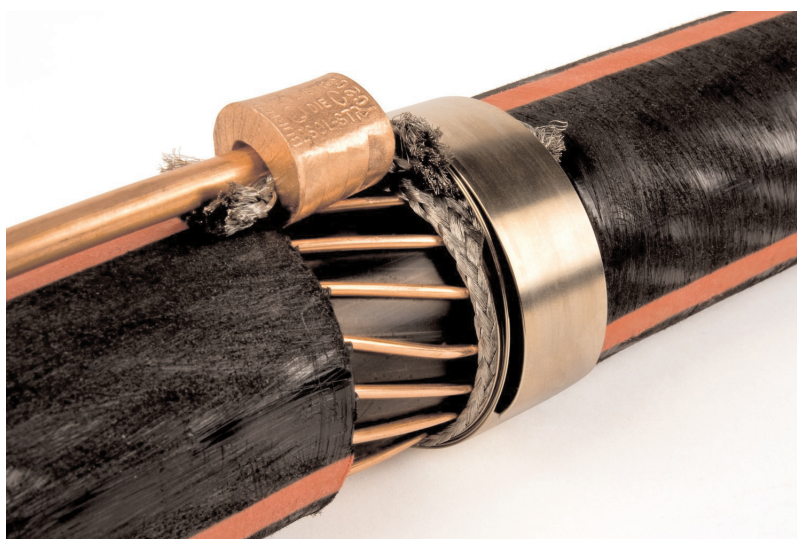

Section	Page
Outage Protection Products .....	338
Sealing and Grounding Kits .....	339-344
Splice Repair .....	345
Cable Breakout Boots and Phase Re-jacketing System .....	345-347
Sheath Seal Kits .....	347-348
Electrical Resins .....	348-352
Cold Shrink Trifurcating Accessory Kit.....	353
Cold Shrink Corrosion Protection Kits.....	354
Cold Shrink End Caps.....	354
Mounting Brackets .....	355
Preparation and Cleaning.....	356-357
3M™ Wraparound Heat Shrink Cable Repair HDCW Sleeves.....	357-358
Splice Jacketing, Re-jacketing and Cable Repair .....	359-364
3M™ Splice Jacketing and Re-jacketing Kits.....	360-364

## Overhead Conductor Animal Guard Cover

3M™ Conductor Covers CCI Series are extruded silicone rubber tubes designed for field installation over bare conductors to insulate them from adjacent phases, grounded equipment, and animal contact. These covers are made with a full-length longitudinal bias cut to allow for easy slip-on installation, and provide an increased creepage distance between the conductor and the outer surface of the cover.

The covers are offered in two thickness sizes for covering both 15 kV and 25 kV rated conductors, and are available in ACSR conductor sizes from 2 AWG–266 kcmil.

Features:

- ◆ Excellent UV, arc and ozone resistance
- ◆ Good dielectric strength, conformability and cold weather installation
- ◆ Munsel grey color
- ◆ Bias cut enables easy field installation without any special tools

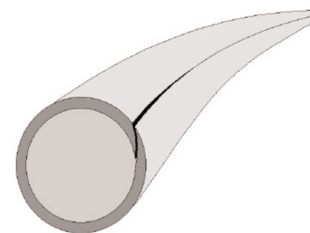

CCI Series  
Conductor Covers

**Voltage** 15–25 kV

Order No.	UPC	ACSR Conductor Size	Conductor Voltage Rating	Insulation Diameter	Insulation Thickness	Case Qty.
CCI-2-125	051141-04238	2 AWG	15 kV	0.34" (9 mm)	0.125" (3 mm)	100 ft. rolls
CCI-2/0-125	051141-04239	2/0 AWG	15 kV	0.46" (12 mm)	0.125" (3 mm)	100 ft. rolls
CCI-266-125	051141-04241	266 kcmil	15 kV	0.63" (16 mm)	0.125" (3 mm)	100 ft. rolls
CCI-2/0-200	051141-04240	2/0 AWG	25 kV	0.46" (12 mm)	0.200" (5 mm)	100 ft. rolls
CCI-266-200	051141-04242	266 kcmil	25 kV	0.63" (16 mm)	0.200" (5 mm)	100 ft. rolls

## 3M™ Electrostatic Animal Guard

This is a patented electrostatic barrier that attaches to energized electrical insulators/bushings rated up to 35 kV.

The 3M™ Electrostatic Animal Guard consists of rugged plastic with metal spokes radiating outward. When an animal touches the spokes, it receives an electric shock, similar to those generated by electrified livestock fences. The animal is not injured and power service is not interrupted.

Note: Insulator neck diameter range is defined as the diameter of the insulator in between the skirts.

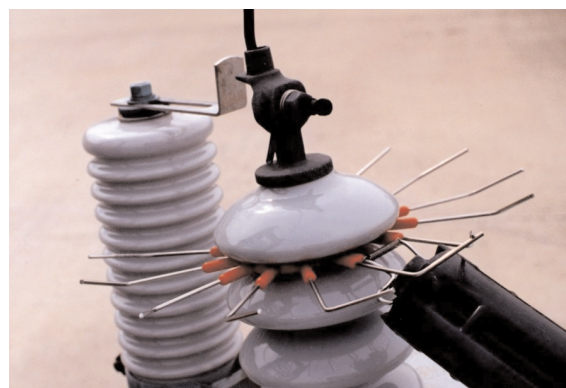

**Voltage** 35 kV and less

Order No.	UPC	Insulator Neck Diameter Range	Case Qty.
GG-7525	054007-43128	0.75"–2.50" (19,1–63,7 mm)	100
GG-1525	054007-43125	1.50"–2.50" (38,2–63,7 mm)	100
GG-2545	054007-43126	2.50"–4.50" (63,7–114,7 mm)	100
GG-4565	054007-43127	4.50"–6.50" (114,7–165,7 mm)	100

## 3M™ Cold Shrink Cable Accessory Sealing Kits 8450 Series

The 3M™ Cold Shrink Cable Accessory Sealing Kits 8450 Series are designed to seal the jacket end of power cables where elbows or other cable accessories are installed. Both the sealing tube and mastic are compatible with commonly used power cable jacketing and semiconductive materials.

Each kit contains enough materials to seal one cable jacket end. Kit contents include: Cold Shrink sealing tube; 6" (15,24 cm) mastic sealing strips (3 strips in 8452/8452L, 4 strips in 8453, 6 strips in 8454); and Instruction sheet.

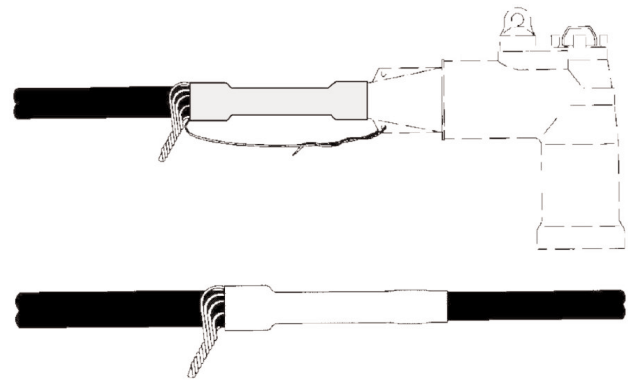

<b>Voltage</b>	15-35 kV
<b>Cable/Shielding Type</b>	Jacketed Concentric Neutral (JCN)
<b>Component Type</b>	Accessory Kit
<b>RoHS 2011/65/EU</b>	Yes

	8452	8452L	8453	8454
UPC	054007-08336	054007-44312	054007-09676	054007-49938
Typical Expanded Tube Length	4.50" (114 mm)	5.00" (127 mm)	6.50" (165 mm)	7.50" (190 mm)
Typical Relaxed Tube Length	6.00" (150 mm)	6.50" (165 mm)	8.00" (200 mm)	9.00" (225 mm)
Expanded Tube Diameter	2.12" (53 mm)	2.12" (53 mm)	2.85" (73 mm)	3.87" (98 mm)
Minimum Seal Diameter	0.95" (24 mm)	0.95" (24 mm)	1.28" (33 mm)	1.60" (41 mm)
Maximum Installed Diameter	1.94" (49 mm)	1.94" (49 mm)	2.67" (68 mm)	3.50" (89 mm)
Cable Size for 15 kV Class	2-4/0 AWG (35-100 mm <sup>2</sup> )	2-4/0 AWG (35-100 mm <sup>2</sup> )	2/0 AWG-1000 kcmil (70-500 mm <sup>2</sup> )	750-1500 kcmil (380-725 mm <sup>2</sup> )
Cable Size for 25 kV Class	2-2/0 AWG (35-50 mm <sup>2</sup> )	2-2/0 AWG (35-50 mm <sup>2</sup> )	1/0 AWG-750 kcmil (60-380 mm <sup>2</sup> )	600-1250 kcmil (325-625 mm <sup>2</sup> )
Cable Size for 35 kV Class	1/0 AWG (60 mm <sup>2</sup> )	1/0 AWG (60 mm <sup>2</sup> )	1/0 AWG-500 kcmil (60-250 mm <sup>2</sup> )	350-1000 kcmil (180-500 mm <sup>2</sup> )
Kits per Case	10	10	10	10

## Sealing and Grounding Kits

### 3M™ Cold Shrink Shield Adapter Kits 8459/8460 Series

3M™ Cold Shrink Shield Adapter Kits are designed for grounding and sealing tape shield, wire shield and Unishield® power cables when using cable accessories such as elbows, modular splices and terminations. The Shield Adapter Kit design provides a fault current capacity of 600 amps on 15–35 kV class cables.

These cold shrink kits require no heat, special tools or special skills to install. The cold shrink kits come complete with all necessary components (except the cable accessory) and are installed in a few simple steps. We've even attached a "bleeder wire" to the ground strap eliminating the need for additional wire and connectors.

Each kit contains enough material to ground one cable accessory.

<b>Voltage</b>	15-35 kV
<b>Current</b>	600 Ampere
<b>Cable/Shielding Type</b>	Tape Shield, Wire Shield, Unishield®
<b>Component Type</b>	Accessory

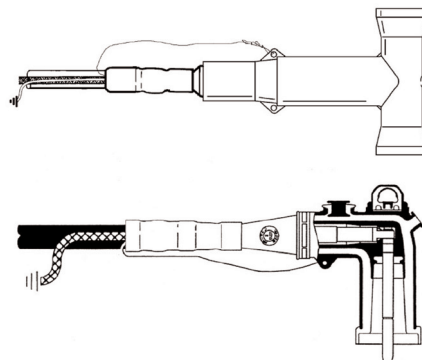

Order No.	UPC	Jacket O.D. Size	Cond. Size 5/8 kV	Cond. Size 15 kV	Cond. Size 25 kV	Cond. Size 35 kV	Kits/Case
8459	051128-53236	0.59"-1.05" (15,0-26,6 mm)	8-1 AWG (10-38 mm <sup>2</sup> )	-	-	-	3
8460	054007-41458	0.83"-1.64" (21,1-41,6 mm)	1/0 AWG-350 kcmil (50-200 mm <sup>2</sup> )	2 AWG-250 kcmil (35-150 mm <sup>2</sup> )	2 AWG-250 kcmil (35-150 mm <sup>2</sup> )	2-1/0 AWG (35-60 mm <sup>2</sup> )	3
8461	054007-41459	1.27"-2.17" (32,3-55,1 mm)	500-1000 kcmil (240-500 mm <sup>2</sup> )	350-1000 kcmil (185-500 mm <sup>2</sup> )	350-750 kcmil (185-500 mm <sup>2</sup> )	2/0 AWG-350 kcmil (70-200 mm <sup>2</sup> )	3
8462	051128-53131	1.70"-2.60" (43,2-66,0 mm)	-	1250-1750 kcmil (600-850 mm <sup>2</sup> )	1000-1500 kcmil (600-725 mm <sup>2</sup> )	500-1000 kcmil (240-500 mm <sup>2</sup> )	3

## Sealing and Grounding Kits

### 3M™ Ground Strap Assembly GS Series

3M™ Ground Strap Assembly Kits GS Series are designed for grounding tape- and wire-shielded power cables.

**Voltage** 5-35 kV

**Cable/Shielding Type** Tape- & Wire-Shielded Power Cables

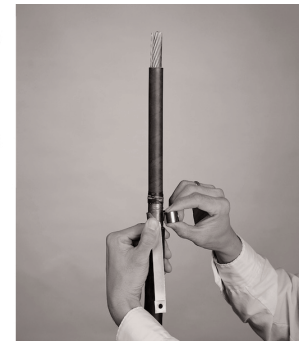

Order No.	UPC 054007-	Strap (LxW)	Conductor Size 5 kV-100% (90 mil)	Conductor Size 5 kV- 133%/ 8 kV-100% (115 mil)	Conductor Size 8 kV- 133% (140 mil)	Conductor Size 15 kV- 100% (175 mil)	Conductor Size 15 kV- 133% (220 mil)	Conductor Size 25 kV (260 mil)	Conductor Size 35 kV (345 mil)	Bags/ Case
GS-1	33976	4.75" x 0.31" (120,7 x 7,9 mm)	8-3/0 AWG (10-80 mm <sup>2</sup> )	8-1/0 AWG (10-50 mm <sup>2</sup> )	8-1 AWG (10-38 mm <sup>2</sup> )	-	-	-	-	9
GS-2	33977	7.12" x 0.62" (180,8 x 15,7 mm)	2/0 AWG-750 kcmil (70-325 mm <sup>2</sup> )	1/0 AWG-750 kcmil (60-325 mm <sup>2</sup> )	1 AWG-600 kcmil (50-300 mm <sup>2</sup> )	2 AWG-500 kcmil (35-250 mm <sup>2</sup> )	2 AWG-350 kcmil (35-180 mm <sup>2</sup> )	2 AWG-400 kcmil (35-200 mm <sup>2</sup> )	1/0 AWG- 300 kcmil (60-150 mm <sup>2</sup> )	9
GS-3	33978	6.87" x 0.62" (175,0 x 15,7 mm)	600-2000 kcmil (325-1000 mm <sup>2</sup> )	500-2000 kcmil (300-1000 mm <sup>2</sup> )	400-1750 kcmil (240-850 mm <sup>2</sup> )	350-1750 kcmil (180-850 mm <sup>2</sup> )	250-1500 kcmil (125-725 mm <sup>2</sup> )	3/0 AWG- 1000 kcmil (95-500 mm <sup>2</sup> )	1/0 AWG- 750 kcmil (60-325 mm <sup>2</sup> )	9

### 3M™ Constant Force Spring

3M™ Constant Force Springs are a range of solderless connections for earthing or grounding use on:

- ♦ Lead and aluminium cable sheaths
- ♦ Cable screening tapes or wires
- ♦ Steel or aluminum armour wires

The springs are easily applied by rolling onto the cable core or outside diameter, whereupon it continues to exert a constant radial pressure.

**RoHS 2011/65/EU** Yes





Order No.	UPC	Application Range	Width	Springs per Case
CFS-.47/1.78	054007-42372	0.50"-0.75" (12,7-19,0 mm)	0.500" (12,7 mm)	30
CFS-.80/1.50	054007-42374	0.80"-1.50" (20,3-38,1 mm)	0.625" (15,9 mm)	30
CFS-1.00/2.20	054007-42375	1.00"-2.20" (25,4-56,0 mm)	0.625" (15,9 mm)	30
CFS-1.50-3.00	054007-42376	1.50"-3.00" (38,1-76,2 mm)	0.625" (15,9 mm)	9
CFS-1.50/3.00W	054007-42378	1.50"-3.00" (38,1-76,2 mm)	0.750" (19,0 mm)	9
CFS-1.80/4.00	054007-42379	1.80"-4.00" (45,7-101,6 mm)	0.625" (15,9 mm)	9

## 3M™ Shield Grounding Accessory Kits GSK

3M™ Shield Grounding Accessory Kits GSK Series are designed to convert concentric neutral (CN) or jacketed concentric neutral (JCN) QT-II or QT-III termination kits for use on longitudinally corrugated (LC) and tape shielded power cables. The GSK kits eliminate the need to stock separate termination kits for shielded power cables. The ground braids provided in the GSK kits are designed for applications where high ampacity grounding is desired.

\* **Conductor Size Ranges expressed in AWG & kcmil.**

<p><b>Voltage</b> 5–35 kV</p> <p><b>Cable/Shielding Type</b> Tape Shield, Longitudinally Corrugated (LC)</p> <p><b>Shield Diameter Range (GSK-22)</b> 0.74"–1.18" (18,8–30,0 mm)</p> <p><b>Shield Diameter Range (GSK-34)</b> 0.82"–1.63" (20,8–41,4 mm)</p> <p><b>Shield Diameter Range (GSK-56)</b> 1.15"–2.42" (29,2–61,5 mm)</p> <p><b>Packaging</b> 3 kits per case</p>	 <p>Tape Shielded Cable</p>  <p>Longitudinally Corrugated (LC) Shielded Cable</p>
--	---

Order No.	UPC	Compatible with	5 kV (90 mil) AWG & kcmil	5/8 kV (115 mil) AWG & kcmil	8 kV (140 mil) AWG & kcmil	15 kV (175 mil) AWG & kcmil	15 kV (220 mil) AWG & kcmil	25/28 kV (260/280 mil) AWG & kcmil	35 kV (345 mil) AWG & kcmil
GSK-22	051128-53087	QT-II 5641	3/0-300	2/0-250	1/0-4/0	2-3/0	2-1/0	-	-
		QT-II 5651	3/0-300	2/0-250	1/0-4/0	2-3/0	2-1/0	2-1	-
		QT-III 7642-T-110	4/0-400	3/0-350	-	2-4/0	2-4/0	-	-
		QT-III 7642-S-2	4/0-400	3/0-350	-	2-4/0	2-4/0	-	-
		QT-III 7652-S-4	4/0-400	3/0-350	-	2-4/0	2-4/0	-	-
GSK-34	051128-53088	QT-II 5642	350-750	300-750	250-600	3/0-500	2/0-350	-	-
		QT-II 5652	350-750	300-750	250-600	3/0-500	2/0-350	1/0-250	-
		QT-II 5646	350-750	300-750	250-600	3/0-500	2/0-350	1/0-250	2-3/0
		QT-III 7653-S-4	300-500	250-500	4/0-350	2/0-300	2/0-300	2-4/0	-
		QT-III 7654-S-4	500-750	350-700	250-500	4/0-500	4/0-500	2/0-250	-
		QT-III 7644-T-110	500-750	350-700	250-500	4/0-500	4/0-500	-	-
		QT-III 7653-T-150	300-500	250-500	4/0-350	2/0-300	2/0-300	2-4/0	2-2/0
		QT-III 7663-S-8	300-500	250-500	4/0-350	2/0-300	2/0-300	2-4/0	2-2/0
QT-III 7664-S-8	500-750	350-700	250-500	4/0-500	4/0-500	2/0-250	2-4/0		
GSK-56	051128-53089	QT-II 5643	750-1500	750-1250	600-1000	500-1000	350-500	-	-
		QT-II 5644	1000-2000	1000-2000	800-1750	750-1750	600-1500	-	-
		QT-II 5653	750-1500	750-1250	600-1000	500-1000	350-500	300-500	-
		QT-II 5654	1000-2000	1000-2000	800-1750	750-1750	600-1500	600-1250	-
		QT-II 5647	750-1500	750-1250	600-1000	500-1000	350-500	300-500	4/0-400
		QT-II 5648	1000-2000	1000-2000	800-1750	750-1750	600-1500	600-1250	500-1000
		QT-III 7655-S-4	700-1500	600-1250	500-1000	500-1000	500-1000	250-800	-
		QT-III 7656-S-4	1750-2000	1500-2000	1250-1750	1250-2000	1250-2000	900-1750	-
		QT-III 7645-T-110	700-1500	600-1250	500-1000	500-1000	500-1000	-	-
		QT-III 7646-T-110	1750-2000	1500-2000	1250-1750	1250-2000	1250-2000	-	-
		QT-III 7655-T-150	700-1500	600-1250	500-1000	500-1000	500-1000	250-800	3/0-600
		QT-III 7656-T-150	1750-2000	1500-2000	1250-1750	1250-2000	1250-2000	900-1750	700-1500
		QT-III 7665-S-8	700-1500	600-1250	500-1000	500-1000	500-1000	250-800	3/0-600
		QT-III 7666-S-8	1750-2000	1500-2000	1250-1750	1250-2000	1250-2000	900-1750	700-1500



## Sealing and Grounding Kits

## 3M™ Hi-Amp Splice Grounding Accessory Kits SG-2 and SG-3

3M™ Hi-Amp Splice Grounding Accessory Kits SG-2 and SG-3 are designed to accommodate the shielding and grounding of inline splices made on longitudinally corrugated (LC) shield, heavy-duty tape and conventional tape-shielded power cables. The SG-2 and SG-3 designs provide a fault current capacity of 15,000 Amps for 15 cycles on 15 kV, 25 kV and 35 kV class cables. The 3M kits SG-2 and SG-3 were designed to accommodate 3M™ QS bodies as well as most other rubber-molded inline splices currently used in the electrical power distribution industry.

The 3M Copper Screen Sleeves SG-2 and SG-3 are applied over molded rubber splices on cables with shield diameters ranging from 1.25"-2.25" (31,8-57,2 mm). In most cases this will include conductor sizes between 350-1000 kcmil and voltage classes of 15-35 kV. The 3M copper screen sleeves SG-2 and SG-3 and the preformed ground connection braid have a capacity greater than that of 4 AWG copper wire and are fault current rated at 15,000 amps for 15 cycles. The 3M Kit SG-3 has a larger CMA (greater than 2 AWG) copper screen sleeve and two constant force springs per end. This provides additional neutral current capacity.

Each kit provides shielding and grounding for one splice.

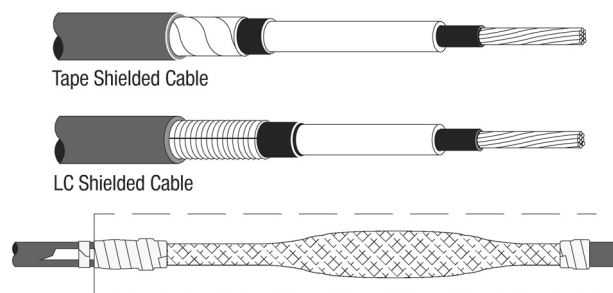

Voltage 15–35 kV

Cable/Shielding Type Tape Shield, Longitudinally Corrugated (LC)

Order No.	UPC	Shield O.D. Range	Conductor Size Range	Circular Mil Area	Kits per Case
SG-2	054007-50041	1.25"-2.25" (31,8-57,2 mm)	350-1000 kcmil	61,000	10
SG-3	054007-41511	1.25"-2.25" (31,8-57,2 mm)	350-1000 kcmil	72,000	10

## 3M™ Hi-Amp Accessory Grounding Kits 8473 and GSHA-8 QT-II

3M™ Hi-Amp Accessory Grounding Kits 8473 and GSHA-8 QT-II are both designed to accommodate the grounding of accessories installed on 15 kV, 25 kV and 35 kV Class longitudinally corrugated (LC), heavy-duty tape and conventional tape-shielded power cables.

The 8473 kit is a cold shrink design to be used with 600-Amp elbows and other accessories where cable jacket-to-accessory sealing and high-ampacity grounding is desired. Its preformed ground braid has a fault current capacity of 15,000 Amps for 15 cycles with an equivalent cross-sectional area greater than 4 AWG copper wire.

The GSHA-8 is designed to accommodate the grounding of terminations made on 15 kV, 25 kV and 35 kV Class longitudinally corrugated (LC), heavy-duty tape and conventional tape-shielded power cables. The 3M Kit GSHA-8 QT-II preformed ground braid design also provides a fault current capacity of 15,000 Amps for 15 cycles on 15–35 kV class cables.

Each kit provides grounding and/or sealing for one accessory or termination.

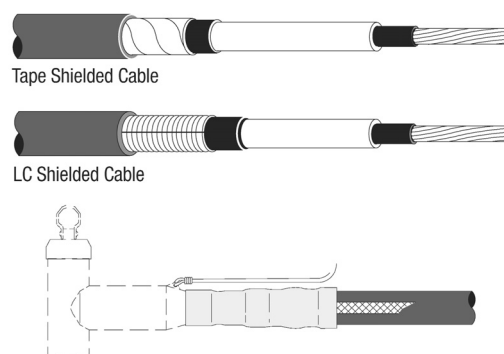

Voltage 15 kV, 25/28 kV, 35 kV

Cable/Shielding Type Tape Shield, Longitudinally Corrugated (LC)

Order No.	UPC	Shield O.D. Range	Conductor Size Range AWG and kcmil	Kits per Case
8473	054007-50043	1.25"-2.25" (31,8-57,2 mm)	350-1000 kcmil	10
GSHA-8	054007-50042	1.25"-2.25" (31,8-57,2 mm)	350-1000 kcmil	10

## Sealing and Grounding Kits

### 3M™ Cable Grounding Kits 2252, 2253 and 2254

The 3M™ Cable Grounding Kits 2252, 2253 and 2254 provide a simple, reliable and secure method for grounding and resealing of the jacket of direct buried distribution cables. These kits are designed for use with jacketed concentric neutral (JCN) power cables ranging from 2–4/0 AWG, rated through 35 kV. A common kit application is for grounding a primary neutral at least every 1320' (1/4 mile) per Rural Utilities Service (RUS) Bulletin 83-1.

Each kit provides enough material for one cable ground.



Jacketed Concentric Neutral Cable (JCN)

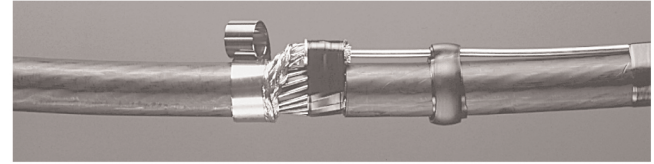

<b>Voltage</b>	35 kV
<b>Cable/Shielding Type</b>	Jacketed Concentric Neutral (JCN)
<b>Agency Approvals</b>	

Order No.	UPC	Conductor Size Range	Kits per Case
2252	054007-08335	2–4/0 AWG	10
2253	051128-55648	250–500 kcmil	10
2254	051128-56939	500–1000 kcmil	10

### 3M™ Cold Shrink Insertion Seal

Seals open space between a steel casing and plastic, gas, or utility pipe. Seal consists of EPDM rubber tubing that is expanded over a removable core and shrinks in diameter.



<b>Technology</b>	Cold Shrink
<b>Material</b>	EPDM Rubber
<b>RoHS 2011/65/EU</b>	Yes

Order No.	UPC	Case Qty.
PS-2	054007-49886	10
PS-3	054007-50201	10
PS-4	054007-49887	10

## Splice Repair

## Lead Sheath Repair Kit

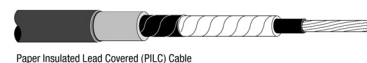

Paper Insulated Lead Covered (PILC) Cable

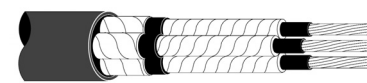

Three-Conductor Paper Insulated Lead Covered (PILC) Cable

Order No.	UPC	Description	Kits per Case
LEAD-SHEATH-REPAIR-KIT	054007-44246	For sealing oil leaks on PILC cable.	1

## Cable Breakout Boots and Phase Rejacketing System

## 3M™ Cold Shrink Silicone Rubber Cable Breakout Boots 8560 Series

3M™ Cold Shrink Silicone Rubber Cable Breakout Boots 8560 Series are a series of open-ended molded rubber sealing assemblies that are factory expanded and mounted on removable inner supporting plastic cores. They are supplied for field installation in a pre-stretched condition. The supporting cores are removed after the seal has been positioned for installation around the breakout area of a 3/C (three-conductor) cable. Core removal allows the silicone rubber boot to shrink down to a pre-determined diameter, creating an environmental enclosure for individual cable phase legs and the overall cable jacket.

3M™ Cold Shrink Silicone Rubber Cable Breakout Boots 8560 Series are designed to protect the phase leg breakout area of 3/C medium voltage shielded power cable from exposure to moisture, contamination, corrosion, ozone, ultra-violet radiation, physical contact and other hazards associated with 3/C termination operating environments.

The 8560 Series Breakout Boots can be used in conjunction with 3M™ Cold Shrink Silicone Rubber Termination Assemblies and 3M™ RJS Series Rejacketing Sleeves for 3/C shielded power cable terminating applications.

Voltage	35 kV and less
Number of Conductors	Three Conductors
Cable/Shielding Type	Shielded Power Cable
Color	Dark Gray
RoHS 2011/65/EU	Yes



Order No.	UPC	Cable Phase Shield Diameter Range	Cable Outer Jacket Diameter Range	Case Qty.
8561	054007-43143	0.48"–0.72" (12,2–18,3 mm)	1.30"–1.94" (33,0–49,3 mm)	1
8562	054007-43144	0.61"–0.95" (15,5–24,1 mm)	1.46"–2.67" (37,1–67,8 mm)	1
8563	054007-43145	0.82"–1.18" (20,8–30,0 mm)	1.92"–3.10" (48,8–78,7 mm)	1
8564	054007-43146	1.02"–1.63" (25,9–41,4 mm)	2.52"–4.32" (64,0–109,7 mm)	1
8565	054007-43147	1.09"–1.94" (27,7–49,3 mm)	2.60"–4.70" (66,0–119,4 mm)	1
8566	051128-58283	1.23"–2.17" (31,2–55,1 mm)	3.18"–5.52" (80,7–140,2 mm)	1

## 3M™ RJS Series Rejacketing Sleeves

The 3M™ RJS Series Rejacketing Sleeves are designed so that 3M™ Cold Shrink QT-III and QT-III Silicone Rubber Terminations can be used on three-conductor (3/C) medium voltage shielded power cables of tape shield, wire shield, armored and non-armored configurations.

The RJS Series rejacketing assemblies are a series of silicone rubber insulators incorporating an inner-expandable polyester braid designed to reduce sliding friction and deliver the insulator onto the cable. Rejacketing sleeves are designed to protect the phase legs (core) of 3/C shielded power cable from exposure to moisture, corrosion, ozone, ultra-violet radiation, physical contact and other hazards associated with termination operating environments.

Rejacketing sleeves are designed to be used in conjunction with 3M™ Cold Shrink Breakout Boots and Silicone Rubber Terminations.



**Voltage 35 kV and less**

**Number of Conductors Three Conductors**

**Cable/Shielding Type Tape Shield, Wire Shield**

**RoHS 2011/65/EU Yes**

	RJS-1-4FT	RJS-1-10FT	RJS-2-4FT	RJS-2-10FT
UPC	054007-43098	054007-43099	054007-43100	054007-43101
Length	4' (1,22 m)	10' (3,05 m)	4' (1,22 m)	10' (3,05 m)
Metallic Shield Diameter Range	0.43"-0.60" (10,9-15,2 mm)	0.43"-0.60" (10,9-15,2 mm)	0.60"-0.80" (15,2-20,3 mm)	0.60"-0.80" (15,2-20,3 mm)
Conductor Size 3.3 kV - IEC	16-35 mm <sup>2</sup>	16-35 mm <sup>2</sup>	50-95 mm <sup>2</sup>	50-95 mm <sup>2</sup>
Conductor Size 3.3 kV - JIS	8-22 mm <sup>2</sup>	8-22 mm <sup>2</sup>	38-60 mm <sup>2</sup>	38-60 mm <sup>2</sup>
Conductor Size 5.0 kV - AEIC	8-2 AWG	8-2 AWG	1-3/0 AWG	1-3/0 AWG
Conductor Size 6.6 kV - JIS	16-25 mm <sup>2</sup>	16-25 mm <sup>2</sup>	35-70 mm <sup>2</sup>	35-70 mm <sup>2</sup>
Conductor Size 6.6 kV - IEC	8-10 mm <sup>2</sup>	8-10 mm <sup>2</sup>	14-38 mm <sup>2</sup>	14-38 mm <sup>2</sup>
Conductor Size 8.0 kV - AEIC	6-4 AWG	6-4 AWG	2-2/0 AWG	2-2/0 AWG
Conductor Size 10 kV - IEC	-	-	10-50 mm <sup>2</sup>	10-50 mm <sup>2</sup>
Conductor Size 15 kV - AEIC	-	-	2-1 AWG	2-1 AWG
Conductor Size 20 kV - IEC	-	-	-	-
Conductor Size 25 kV - AEIC	-	-	-	-
Conductor Size 30 kV - IEC	-	-	-	-
Conductor Size 35 kV - AEIC	-	-	-	-
Sleeves per Case	10	1	10	1
	RJS-3-4FT	RJS-3-10FT	RJS-4-4FT	RJS-4-10FT
UPC	054007-43102	054007-43103	054007-43104	054007-43105
Length	4' (1,22 m)	10' (3,05 m)	4' (1,22 m)	10' (3,05 m)
Metallic Shield Diameter Range	0.80"-1.02" (20,3-25,9 mm)	0.80"-1.02" (20,3-25,9 mm)	1.02"-1.28" (25,9-32,5 mm)	1.02"-1.28" (25,9-32,5 mm)
Conductor Size 3.3 kV - IEC	120-185 mm <sup>2</sup>	120-185 mm <sup>2</sup>	240-300 mm <sup>2</sup>	240-300 mm <sup>2</sup>
Conductor Size 3.3 kV - JIS	100-150 mm <sup>2</sup>	100-150 mm <sup>2</sup>	200-250 mm <sup>2</sup>	200-250 mm <sup>2</sup>
Conductor Size 5.0 kV - AEIC	4/0 AWG-400 kcmil	4/0 AWG-400 kcmil	500-750 kcmil	500-750 kcmil
Conductor Size 6.6 kV - JIS	95-150 mm <sup>2</sup>	95-150 mm <sup>2</sup>	185-300 mm <sup>2</sup>	185-300 mm <sup>2</sup>
Conductor Size 6.6 kV - IEC	60-100 mm <sup>2</sup>	60-100 mm <sup>2</sup>	150-250 mm <sup>2</sup>	150-250 mm <sup>2</sup>
Conductor Size 8.0 kV - AEIC	3/0 AWG-350 kcmil	3/0 AWG-350 kcmil	400-600 kcmil	400-600 kcmil
Conductor Size 10 kV - IEC	70-150 mm <sup>2</sup>	70-150 mm <sup>2</sup>	185-300 mm <sup>2</sup>	185-300 mm <sup>2</sup>
Conductor Size 15 kV - AEIC	1/0-4/0 AWG	1/0-4/0 AWG	250-450 kcmil	250-450 kcmil
Conductor Size 20 kV - IEC	25-70 mm <sup>2</sup>	25-70 mm <sup>2</sup>	95-185 mm <sup>2</sup>	95-185 mm <sup>2</sup>
Conductor Size 25 kV - AEIC	2-1/0 AWG	2-1/0 AWG	2/0 AWG-250 kcmil	2/0 AWG-250 kcmil
Conductor Size 30 kV - IEC	-	-	35-70 mm <sup>2</sup>	35-70 mm <sup>2</sup>
Conductor Size 35 kV - AEIC	-	-	1/0-3/0 AWG	1/0-3/0 AWG
Sleeves per Case	10	1	10	1

## 3M™ RJS Series Rejacketing Sleeves (continued)

	RJS-5-4FT	RJS-5-10FT	RJS-6-4FT	RJS-6-10FT
UPC	054007-43106	054007-43107	051128-54320	051128-54319
Length	4' (1,22 m)	10' (3,05 m)	4' (1,22 m)	10' (3,05 m)
Metallic Shield Diameter Range	1.28"-1.62" (32,5-41,1 mm)	1.28"-1.62" (32,5-41,1 mm)	1.62"-1.91" (41,1-48,5 mm)	1.62"-1.91" (41,1-48,5 mm)
Conductor Size 3.3 kV - IEC	-	-	-	-
Conductor Size 3.3 kV - JIS	300-325 mm <sup>2</sup>	300-325 mm <sup>2</sup>	-	-
Conductor Size 5.0 kV - AEIC	800-1000 kcmil	800-1000 kcmil	-	-
Conductor Size 6.6 kV - JIS	-	-	-	-
Conductor Size 6.6 kV - IEC	300-325 mm <sup>2</sup>	300-325 mm <sup>2</sup>	-	-
Conductor Size 8.0 kV - AEIC	750-1000 kcmil	750-1000 kcmil	-	-
Conductor Size 10 kV - IEC	-	-	-	-
Conductor Size 15 kV - AEIC	500-750 kcmil	500-750 kcmil	-	-
Conductor Size 20 kV - IEC	240-300 mm <sup>2</sup>	240-300 mm <sup>2</sup>	-	-
Conductor Size 25 kV - AEIC	300-500 kcmil	300-500 kcmil	-	-
Conductor Size 30 kV - IEC	95-240 mm <sup>2</sup>	95-240 mm <sup>2</sup>	-	-
Conductor Size 35 kV - AEIC	4/0 AWG-500 kcmil	4/0 AWG-500 kcmil	-	-
Sleeves per Case	10	1	1	1

### Sheath Seal Kits

## 3M™ Sheath Seal Kits 5831 and 5832

The 3M™ Sheath Seal Kits 5831 and 5832 are designed to seal the sheath area for multi-conductor cables with or without ground wires. These kits handle copper or aluminum cable from 2 AWG-500 kcmil (35-250 mm<sup>2</sup>). Each kit makes one seal.

Number of Conductors Multiple Conductor  
RoHS 2011/65/EU Yes

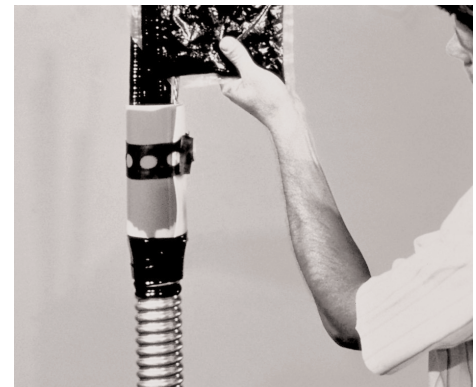

Order No.	UPC	Conductor Size	Maximum Jacket or Armor O.D.	Kits per Case
5831	051128-59173	2-3/0 AWG (35-80 mm <sup>2</sup> )	2.60" (66,0 mm)	1
5832	051128-59174	4/0 AWG-500 kcmil (120-250 mm <sup>2</sup> )	3.75" (95,3 mm)	1



## Sheath Seal Kits

### 3M™ Cold Shrink Sheath Seal Kits 5841 and 5842

The 3M™ Cold Shrink Sheath Seal Kits 5841 and 5842 are designed to seal the sheath area for three-conductor (3/C) cables without ground wires. They handle both copper and aluminum cables from 2AWG-500 kcmil (35-250 mm<sup>2</sup>). No heat is required when using these kits. Each kit makes one seal.

Number of Conductors Three Conductor  
RoHS 2011/65/EU Yes

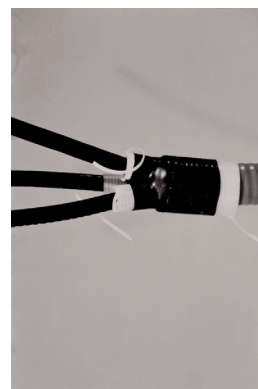

Order No.	UPC	Conductor Size	Conductor Insulation O.D.	Cable Jacket Range	Kits per Case
5841	054007-12291	2-4/0 AWG (35-100 mm <sup>2</sup> )	0.30"-1.18" (7,6-30,0 mm)	1.20"-1.90" (30,5-48,3 mm)	1
5842	054007-12292	4/0 AWG-500 kcmil (120-250 mm <sup>2</sup> )	0.77"-1.38" (19,6-35,1 mm)	1.80"-3.10" (45,7-78,7 mm)	1

## Electrical Resins

### 3M™ Scotchcast™ Electrical Insulating Resin 4

3M™ Scotchcast™ Electrical Insulating Resin 4 is a two-part epoxy insulating and encapsulating resin. This resin, mixed in its two-part closed mixing pouch, generates its own heat to cure. Its compatibility with solid and synthetic cable insulations and jackets makes Resin 4 an excellent insulator and sealer for cable splicing. Use 3M™ Scotchcast™ Electrical Insulating Resin 4 to splice solid dielectric and oil filled cables up to 8 kV and to jacket high voltage splices. It is included in the 3M™ Scotchcast™ Splice Kits 82-H Series, 82-B1, 85-14CP and 90-B1. Gel time is 16 min. at 23°C.

\*At 73°F (23°C) and cooler temperatures, resin will cure slower. Do not energize until resin has cooled and solidified.

Voltage	8 kV or less (for splicing solid dielectric and oil filled cables)
Cure Time	1 to 2 Hours at 70°F (21°C) 4 to 8 Hours at 50°F (10°C)
Energize Time	45 minutes*
Max. Operating Temperature	194°F (90°C) continuous
Color	Black
RoHS 2011/65/EU	Yes
Used in these kits	82-A Series; 82-B1; 85-14CP; 90-B1



Order No.	UPC	Packaging Description	Weight oz (g)	Volume in <sup>3</sup> (cm <sup>3</sup> )	Containers per Case
4A	054007-43165	2-part pouch	3.1 (88)	4.8 (78,6)	10
4B	054007-43166	2-part pouch	7.2 (205)	11.1 (181,9)	10
4C	054007-43167	2-part pouch	14.6 (414)	22.5 (368,7)	10
4D	054007-04206	2-part pouch	21.8 (619)	33.6 (550,6)	10
4E	054007-04207	2-part pouch	10.1 (288)	15.6 (255,6)	10



## Electrical Resins

### 3M™ Armorcast Structural Material 4560

3M™ Armorcast Structural Material 4560 is a flexible fiberglass knit fabric strip that has been saturated with a black urethane resin syrup. The material is rolled and packed dry in a sealed foil envelope. Armorcast structural material is completely safe for use in manholes, vaults, and other hazardous environments, because no heat source is required. No flames, electric heaters or chemicals are needed. The only thing your crews will ever have to add is water.

Material	Fiberglass
RoHS 2011/65/EU	Yes
Agency Approvals	RUS



Order No.	UPC	Color	Roll Size	Case Qty.
4560-5	051138-57719	Black	5 ft (1,52 m)	5
4560-10	051138-57717	Black	10 ft (3,05 m)	5
4560-15	051138-57718	Black	15 ft (4,57 m)	5

### 3M™ Scotchcast™ Electrical Insulating Resin 2104

3M™ Scotchcast™ Electrical Insulating Resin 2104 is a hard, two-part, polyurethane resin encapsulant designed specifically for permanent splice protection. Resin 2104 is formulated for virtually every electrical application requiring hard, non-reenterable resin with good handling and performance characteristics. Resin 2104 is also used as the insulating material for cable splices operating at 1000 volts or less and is rated for continuous use at 194°F (90°C) with an overload rating of 266°F (130°C). It may be stocked to cover all hard resin needs, ending the need for multiple encapsulant inventories.

Voltage	1000 Volts or less
Cure Time	1 Hour at 70°F (21°C) 20 Hours at 20°F (-4°C)
Energize Time	Immediately
Max. Operating Temperature	194°F (90°C) continuous
Color	Dark Green
RoHS 2011/65/EU	Yes
Used in these kits	72-N; 85 Series



Order No.	UPC	Packaging Description	Weight oz (g)	Volume in <sup>3</sup> (cm <sup>3</sup> )	Containers per Case
2104A	054007-31189	2-part pouch	3.46 (98)	5.7 (93,4)	10
2104B	054007-31382	2-part pouch	7.40 (210)	12.6 (206,4)	10
2104C	054007-31383	2-part pouch	14.82 (420)	25.4 (416,2)	10
2104D	054007-11849	2-part pouch	23.80 (675)	40.8 (668,5)	10
2104E	054007-31187	2-part pouch	10.6 (300)	19.1 (313,5)	10

## 3M™ Scotchcast™ Re-Enterable Electrical Insulating Resin 2123

3M™ Scotchcast™ Re-enterable Electrical Resin 2123 is a soft, two-part polybutadiene resin encapsulant designed especially for re-enterable splice protection. It is formulated for virtually every electrical application requiring a soft, re-enterable resin with good handling and performance characteristics. This resin is also used as the insulating material for cable splices operating at 1000 volts, and is rated for continuous use at 194°F (90°C) with an overload rating at 266°F (130°C). It may be stocked to cover most re-enterable resin needs, ending the need for multiple encapsulant inventories.

Scotchcast Resin 2123 is formulated with excellent wetting properties and low viscosity. The resin flows well even at low temperatures, filling the enclosure and minimizing voids. Scotchcast Resin 2123 is packaged in a convenient two-part closed mixing pouch.

<b>Voltage</b>	1000 Volts or less
<b>Cure Time</b>	24 Hours @70°F (21°C)
<b>Energize Time</b>	Immediately
<b>Max. Operating Temperature</b>	194°F (90°C) continuous
<b>Color</b>	Amber, Translucent
<b>RoHS 2011/65/EU</b>	Yes
<b>Used in these kits</b>	78-R Series



Order No.	UPC	Package Description	Weight, oz (g)	Volume, in <sup>3</sup> (cm <sup>3</sup> )	Containers per Case
2123C	051128-55120	2-part pouch	12.3 (350)	23.7 (338,3)	10
2123D	051128-55121	2-part pouch	21.2 (600)	40.6 (665,3)	10

## Electrical Resins

### 3M™ Scotchcast™ Flame-Retardant Compound 2131

3M™ Scotchcast™ Flame-Retardant Compound 2131 is a two-part polyurethane resin designed to replace the cable jacket when splicing or repairing mine and portable cables. Its unique formulation makes it particularly suited to withstand the rugged conditions under which mine and portable cables must operate. When used in accordance with the appropriate kit configuration, Compound 2131 conforms to MSHA Part 7, Title 30 CFR.

Flame-Retardant Compound 2131 is also used as the insulating material for cable splices operating at up to 1000 volts and designed for 194°F (90°C) at continuous use and for 266°F (130°C) at temporary, overload temperature.

3M™ Scotchcast™ Flame-Retardant Compound 2131 comes in two sizes of 2-part pouch containers, as well as separate 5 gallon jugs for both Part A and Part B. (Note: 2.1 parts of B required for every 1 part of A by weight.)

<b>Voltage</b>	1000 Volts or less
<b>Cure Time</b>	16 to 24 Hours at 70°F (21°C)
<b>Energize Time</b>	Immediately
<b>Max. Operating Temperature</b>	194°F (90°C) continuous
<b>Color</b>	Black
<b>RoHS 2011/65/EU</b>	Yes
<b>Used in these kits</b>	5750; 5760; 5831; 5832; 82-F1; 82-F2; 82-BF1; M-20; M-30; M-40



Order No.	UPC	Packaging Description	Weight	Volume in³ (cm³)	Case Qty.
2131B	051128-59166	2-part pouch	7.5 oz (213 g)	10.6 (175)	10
2131C	051128-59167	2-part pouch	21.5 oz (612 g)	30.6 (502)	10
2131-Part A 5 Gal	051128-59181	5 gallon jug, Part A	44.5 lb (20.1 kg)		1 pail
2131-Part B 5 Gal	051128-59182	5 gallon jug, Part B	46.5 lb (21 kg)		1 pail

## Electrical Resins

### 3M™ Scotchcast™ Potting Kit 2136

The 3M™ Scotchcast™ Potting Kit 2136 is designed to provide protection against corrosion and possible deteriorating effects of fresh swimming pool or fountain water and sunlight by reliably encapsulating the 8 AWG ground connection in a wet-niche shell as required by NEC® when using rigid, non-metallic conduit in the installation of wet-niche

underwater lighting fixtures. Scotchcast 2136 compound is UL Listed as a potting compound for swimming pool, fountain, or spa equipment and is for use only where adhering to copper, copper alloy and stainless steel materials.

3M™ Scotchcast™ Potting Compound 2136 is a thixotropic polyurethane resin, designed to resist dripping or sagging, and contained in an easy mix 1.5 oz. closed mixing pouch. At temperatures above 40°F (18°C) the compound will firm up in minutes. Encapsulated connections should be allowed to cure for 4 hours prior to submersion.

<b>Voltage</b>	Up to 1000 Volts; UL Listed up to 600 Volts
<b>Cure Time</b>	4 Hours at 70°F (21°C)
<b>Energize Time</b>	Immediately
<b>Max. Operating Temperature</b>	UL Listed 20L02 220°F (105°C)
<b>Color</b>	Black
<b>RoHS 2011/65/EU</b>	Yes



Order No.	UPC	Material	Weight, oz (g)	Containers per Case
2136	051128-59190	Potting Compound	1.50 (42,5)	10

### Resin Kit Accessories

Order No.	UPC	Product Name	Description	Items per Case
F-10	054007-09142	3M™ Funnel PE 2.75 Large M-Series F-10	Funnel used with M-series molds for resin re-jacketing or cable repair with 3M Scotchcast™ Resins 2130.	1
E-4	054007-25701	3M™ Resin Pressure Gun E-4	Reusable resin pressure gun used for constructing a resin pressure splice.	1

Cold Shrink Trifurcating Accessory Kit

## 3M™ Cold Shrink MT-C & MT-E Trifurcating Accessory Kits (One 3/C to Three 1/C) for 5/8 kV

3M™ Cold Shrink MT-C and MT-E Trifurcating Accessory Kits are used to break out and seal a transition from 3/C to three 1/C.

For use with 3M™ Cold Shrink QS-III Splicing Series 5700A-MT.

**NOTE: Cable sizes shown below are for standard insulation thickness. Final determining factor is cable insulation O.D.**

**Voltage:** 5/8 kV

**Number of Conductors:** One 3/C to three 1/C



### Selection Table

3M™ Splice 57XXA-MT	5/8 kV (90/140 mil)	Appropriate MT Transition Kit
*Typical Conductor Size Range – AWG/kcmil		
5775A-MT	3/0-250	MT-C
5776A-MT	350	MT-C
5776A-MT	500	MT-E
5777A-MT	—	MT-E

Order No.	UPC	Single Conductor Jacket O.D.	Kits per Case
MT-C	051128-55208	0.62"-1.13" (15,7-28,7 mm)	1
MT-E	051128-54318	1.13"-1.80" (28,7-45,7 mm)	1

## Cold Shrink Corrosion Protection Kits

### 3M™ Cold Shrink Corrosion Protection Kit CPT Series

3M™ Cold Shrink Corrosion Protection Kit CPT Series are designed to provide a quick and easy method for protecting bulkhead termination connectors from the corrosive influences of wet and salt-fog installation environments.

A CPT series assembly is an open-ended tubular rubber sleeve which is factory expanded and assembled onto a removable core. The core is removed after the assembly has been positioned for installation over a bulkhead terminator connector. Mastic strips are provided for sealing between NPT fitting threads and the enclosure in use (junction box, cabinet, panel board, etc.). CPT insulating sleeves are made of an EPDM rubber that contains no chlorides or sulfers.

RoHS 2011/65/EU Yes

Agency Approvals Meets salt spray requirements



Order No.	UPC	Min. Cable O.D.	Max. Connector O.D.	Max. Connector Installed Length	Kits per Case
CPT-1/2	054007-43021	0.50" (12,7 mm)	1.60" (40,6 mm)	4.50" (114 mm)	10
CPT-3/4	054007-43022	0.66" (16,8 mm)	1.90" (48,3 mm)	4.80" (122 mm)	10
CPT-1	054007-43023	0.66" (16,8 mm)	2.20" (55,9 mm)	4.80" (122 mm)	10
CPT-1-1/4	054007-43024	1.22" (31,0 mm)	2.65" (67,3 mm)	4.80" (122 mm)	10
CPT-1-1/2	054007-43025	1.40" (35,6 mm)	3.00" (76,2 mm)	5.50" (140 mm)	10
CPT-2	054007-43026	1.68" (42,7 mm)	3.60" (91,4 mm)	6.50" (165 mm)	10
CPT-2-1/2	054007-43027	1.97" (50,0 mm)	4.30" (109,2 mm)	8.50" (215 mm)	5
CPT-3	054007-43028	2.60" (66,0 mm)	5.40" (137,2 mm)	10.50" (266 mm)	5
CPT-3-1/2	054007-43029	2.90" (73,7 mm)	6.00" (152,4 mm)	13.50" (343 mm)	5
CPT-4	054007-43030	2.90" (73,7 mm)	6.00" (152,4 mm)	13.00" (330 mm)	5

## Cold Shrink End Caps

### 3M™ Cold Shrink End Caps EC-Series

3M™ Cold Shrink End Caps EC-Series are close-ended, tubular rubber sleeves that are factory expanded and loaded onto a removable core. When positioned over the end of a cable or other cylindrical object, the core is removed to provide a reliable environmental seal. Four different end caps are available to accommodate a wide range of sizes.

Color Black

RoHS 2011/65/EU Yes



Order No.	UPC	Use Range	Sleeves per Case
EC-1	051128-58388	0.46"–0.82" (11,6–20,9 mm)	10
EC-2	051128-58389	0.63"–1.18" (15,9–30,1 mm)	10
EC-3	051128-58390	1.02"–1.94" (26,0–49,3 mm)	10
EC-4	051128-58391	1.79"–3.32" (45,6–84,3 mm)	10



## Mounting Brackets

### 3M™ Cross-Arm Mounting Brackets MB-1

The 3M™ Cross-Arm Mounting Bracket MB-1 is a cross-arm bracket for use in holding terminated cable. The MB-1 is ideal to use when ordering the MB or MBS termination mounting brackets featured on this page.



Order No.	UPC	Compatible with	Brackets per Case
MB-1	054007-11230	3M™ Mounting Brackets MB and MBS Series	10 each

### 3M™ Mounting Brackets MB and MBS Series

The 3M™ Mounting Brackets MB and MBS Series have been designed to mount 3M™ Molded Rubber Terminations. The MB series brackets are made from galvanized steel, while the MBS series brackets are made from stainless steel to provide corrosion protection in highly contaminated environments. These brackets are attached to the cable just below the termination. This provides a tongue that can then be attached to an MB-1 mounting bracket or to any other support.

\* CAUTION: Use cable O.D., not insulation O.D. for determining the proper size.

\*\* Has double-clamps.

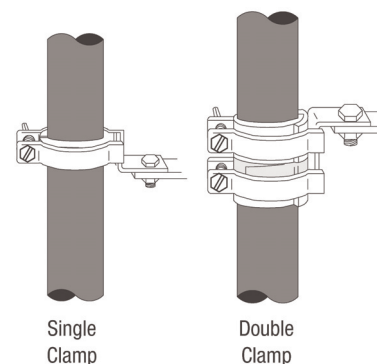

Order No.	UPC	Cable O.D. Range	Brackets per Case
MB-3	054007-14754	0.80"–1.25" (20,3–31,8 mm)	10 each
MB-4	054007-14755	1.10"–1.50" (27,9–38,1 mm)	10 each
MB-5**	054007-08200	1.45"–1.95" (36,8–49,5 mm)	10 each
MB-6**	054007-08286	1.80"–2.40" (45,7–61,0 mm)	10 each
MBS-4**	054007-49685	1.10"–1.70" (27,9–43,2 mm)	10 each
MBS-5**	054007-49686	1.45"–1.95" (36,8–49,5 mm)	10 each
MBS-6**	054007-49687	1.80"–2.40" (45,7–61,0 mm)	10 each

## Preparation and Cleaning

### 3M™ Scotch-Brite™ Hand Pads 7440 Series

3M™ Scotch-Brite™ Hand Pads 7440 Series make the toughest cleaning jobs easier. They resist tearing, splintering, shredding and loading and will never rust. Blending pads are made of a coarse mineral abrasive. General Purpose Pads are reusable—they rinse clean and are constructed of a nylon web. Ultra Fine Pads are highly conformable. 3M Scotch-Brite Hand Pads measure 6" x 9" (152 x 228 mm).

Select the 3M Scotch-Brite Hand Pads for your specific abrasion needs and carry them with you everywhere you work. You can use them on virtually any surface material, including all kinds of metals, plastics, composites, ceramics, porcelain, glass and rubber.



	7446	7447	7448
UPC	048011-04051	048011-04029	048011-04028
Description	Open, aggressive web that is excellent to grain, clean, denib, defuzz and finish. Resistant to loading. May be used by hand, on a hand pad block, or on an in-line sander.	Most universally used in a variety of applications. Excellent starting point to clean, finish, grain, denib and defuzz. May be used by hand, with a hand pad block, or on an in-line sander.	Conformable web and finest silicon carbide hand pad available. Excellent for final finishing and light cleaning. May be used by hand, with a hand block, or on an in-line sander.
Abrasive Mineral Type	Silicon Carbide	Aluminum Oxide	Silicon Carbide
Grade	Medium	Very Fine	Ultra Fine
Color	Gray	Maroon	Light Gray
Length	9" (228,6 mm)	9" (228,6 mm)	9" (228,6 mm)
Width	6" (152,4 mm)	6" (152,4 mm)	6" (152,4 mm)
Pads per Box	10	20	20
Boxes per Case	4	3	3

### 3M™ Cable Cleaning System CC Series

3M™ Cable Cleaning System CC Series cleans cable insulation, metal, electrical and mechanical parts. It can be used for PCB cleanup and in parts cleaners for degreasing.

CC-Dry contains three each 4" x 8" (102 x 203 mm) lintless non-woven pads packed in a bag. These are used for drying the common citrus cable cleaner (CC series) off of cable installation when preparing cable. The CC-2-Dry Kit contains a CC-2 Kit and three each dry lintless pads.

RoHS 2011/65/EU Yes

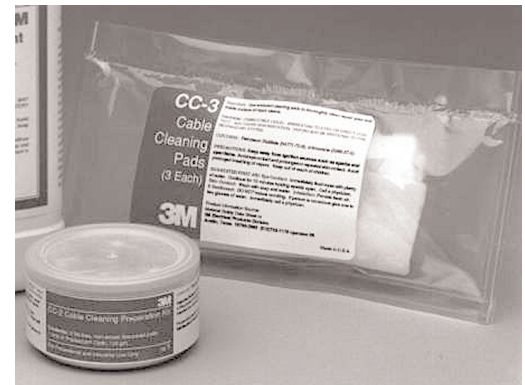

Order No.	UPC	Description	Kit Contents	Kits per Case
CC-2	054007-49563	Cable preparation kit	(3) Saturated cable cleaning pads and (1) Non-conductive grit abrasive cloth	10
CC-DRY	054007-43415	Dry wiping cloth	(3) Unsaturated cable cleaning pads	10
CC-2-DRY	054007-43414	Dry cable preparation kit	(3) Unsaturated cable cleaning pads and (1) Non-conductive grit abrasive cloth	10
CC-3	054007-49564	Cable cleaning pad	(3) Saturated cable cleaning pads	10

## Preparation and Cleaning

## 3M™ Scotch® Electricians' Abrasive Roll A-3

Scotch® Electricians' Abrasive Roll A-3 is a 120-grit, closed-coat aluminum oxide strip, which is nonconductive and flexible. It is packaged in a dispenser-type box.

Abrasive Mineral Type	Aluminum Oxide
Abrasive Backing Weight	J Weight
Abrasive Backing Type	Cloth



Order No.	UPC	Length	Width	Grade	Product Form	Rolls per Case
A-3	054007-11560	75' (22,86 m)	1" (25,4 mm)	120	Roll	10

## 3M™ Wraparound Heat Shrink Cable Repair HDCW Sleeves

### 3M™ Heat Shrink Wraparound Cable Repair Wrap Sleeve HDCW

3M™ Heat Shrink Wraparound Cable Repair Wrap Sleeves HDCW are designed to quickly repair damaged cable jacketing. They may also be used to re-jacket in-line splices. HDCW wrap sleeves can be used as insulation material on cable and splices up to 1000 volts and as jacket repair material on cable up to 35 kV. The design of the wrap sleeve allows it to be installed in tight spaces with ordinary heating equipment such as a torch.

HDCW wrap sleeves are made from modified cross-linked polyolefin, with a hot-melt adhesive liner on the inner side of the sleeve. Upon heating, the sleeve shrinks and the adhesive melts, creating a water-tight bond between the sleeve and the cable. 3M Heat Shrink Wraparound Cable Repair Wrap Sleeves HDCW meet ANSI C119.1 requirements. A corrosion proof metal channel is used to close the sleeve during installation.

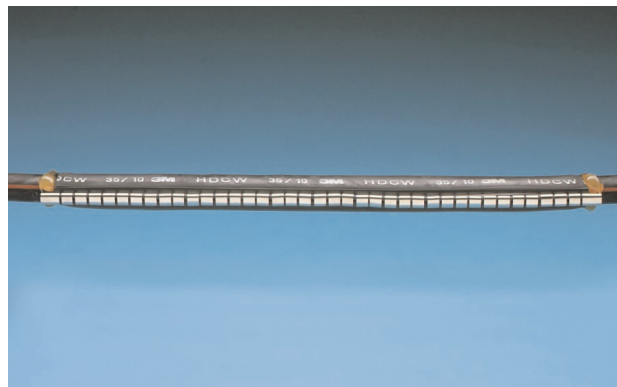

<b>Voltage</b>	1000 Volts Max.
<b>Material</b>	Adhesive-lined, Cross-Linked Polyolefin
<b>RoHS 2011/65/EU</b>	Yes

Order No.	UPC	Cable Size	Sleeve Length	Jacket Repair Use Range	Expanded/Recovered Diameter	Case Qty.
HDCW-35/10-250	051138-48416	8-2/0 AWG	9.8" (250 mm)	1.38"-0.39" (35-10 mm)	1.97"/0.32" (50/8 mm)	5
HDCW-35/10-500	051138-48417	8-2/0 AWG	19.7" (500 mm)	1.38"-0.39" (35-10 mm)	1.97"/0.32" (50/8 mm)	5
HDCW-35/10-750	051138-48418	8-2/0 AWG	29.5" (750 mm)	1.38"-0.39" (35-10 mm)	1.97"/0.32" (50/8 mm)	5
HDCW-35/10-1000	051138-48419	8-2/0 AWG	39.4" (1000 mm)	1.38"-0.39" (35-10 mm)	1.97"/0.32" (50/8 mm)	5
HDCW-35/10-1200	051138-48436	8-2/0 AWG	47.2" (1200 mm)	1.38"-0.39" (35-10 mm)	1.97"/0.32" (50/8 mm)	5
HDCW-55/15-250	051138-48420	3/0 AWG-400 kcmil	9.8" (250 mm)	2.17"-0.59" (55-15 mm)	2.95"/.51" (75/13 mm)	5
HDCW-55/15-500	051138-48421	3/0 AWG-400 kcmil	19.7" (500 mm)	2.17"-0.59" (55-15 mm)	2.95"/.51" (75/13 mm)	5
HDCW-55/15-750	051138-48422	3/0 AWG-400 kcmil	29.5" (750 mm)	2.17"-0.59" (55-15 mm)	2.95"/.51" (75/13 mm)	5
HDCW-55/15-1000	051138-48423	3/0 AWG-400 kcmil	39.4" (1000 mm)	2.17"-0.59" (55-15 mm)	2.95"/.51" (75/13 mm)	5

## 3M™ Wraparound Heat Shrink Cable Repair HDCW Sleeves

### 3M™ Heat Shrink Wraparound Cable Repair Wrap Sleeve HDCW (continued)

Order No.	UPC	Cable Size	Sleeve Length	Jacket Repair Use Range	Expanded/Recovered Diameter	Case Qty.
HDCW-55/15-1200	051138-48437	3/0 AWG-400 kcmil	47.2" (1200 mm)	2.17"-0.59" (55-15 mm)	2.95"/.51" (75/13 mm)	5
HDCW-80/25-250	051138-48424	500-1000 kcmil	9.8" (250 mm)	3.15"-0.98" (80-25 mm)	3.94"/0.91" (100/23 mm)	5
HDCW-80/25-500	051138-48425	500-1000 kcmil	19.7" (500 mm)	3.15"-0.98" (80-25 mm)	3.94"/0.91" (100/23 mm)	5
HDCW-80/25-750	051138-48426	500-1000 kcmil	29.5" (750 mm)	3.15"-0.98" (80-25 mm)	3.94"/0.91" (100/23 mm)	5
HDCW-80/25-1000	051138-48427	500-1000 kcmil	39.4" (1000 mm)	3.15"-0.98" (80-25 mm)	3.94"/0.91" (100/23 mm)	5
HDCW-80/25-1200	051138-48438	500-1000 kcmil	47.2" (1200 mm)	3.15"-0.98" (80-25 mm)	3.94"/0.91" (100/23 mm)	5
HDCW-110/30-500	051138-48429	1000-2000 kcmil	19.7" (500 mm)	4.33"-1.18" (110-30 mm)	5.20"/0.98" (132/25 mm)	5
HDCW-110/30-750	051138-48430	1000-2000 kcmil	29.5" (750 mm)	4.33"-1.18" (110-30 mm)	5.20"/0.98" (132/25 mm)	5
HDCW-110/30-1000	051138-48431	1000-2000 kcmil	39.4" (1000 mm)	4.33"-1.18" (110-30 mm)	5.20"/0.98" (132/25 mm)	5
HDCW-110/30-1200	051138-48439	1000-2000 kcmil	47.2" (1200 mm)	4.33"-1.18" (110-30 mm)	5.20"/0.98" (132/25 mm)	5
HDCW-140/40-1000	051138-48435	N/A	39.4" (1000 mm)	5.51"-1.57" (140-40 mm)	5.71"/1.26" (145/32 mm)	5
HDCW-140/40-1200	051138-48440	N/A	47.2" (1200 mm)	5.51"-1.57" (140-40 mm)	5.71"/1.26" (145/32 mm)	5

# Splice Jacketing, Rejacketing and Cable Repair, For 15–35 kV Cables and Splices

The following 3M products cover splicing needs for applications 15-35 kV, and promote dependable performance, stability and long life with every splice you make.

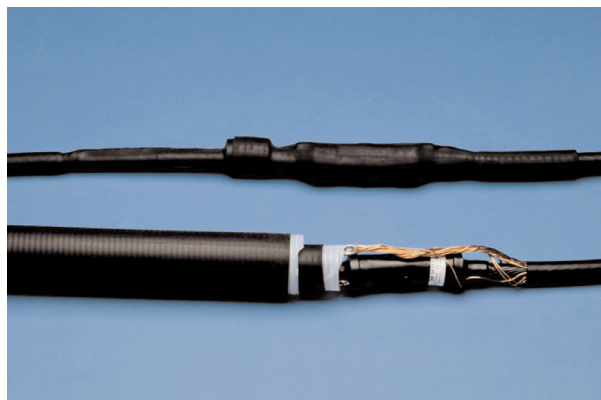

Section	Page
Splice Jacketing, Rejacketing and Cable Repair .....	359-364
3M™ Splice Jacketing and Rejacketing Kits.....	360-364
3M™ Cold Shrink Foldback Splice Jacket Kits.....	360
3M™ Cold Shrink Splice Jacket Kits .....	361
3M™ Cold Shrink Stacked Sleeve Splice Jacket Kits.....	362
3M™ Heat Shrinkable Splice Jacket Kits HSJ Series.....	363
3M™ Scotchcast™ Jacket Repair Kits M Series (up to 2 kV) .....	364

## 3M™ Cold Shrink Foldback Splice Jacket Kits

3M™ Cold Shrink Foldback Splice Jacket Kits SJ-FB Series are a series of folded back, tubular, rubber sleeves that, combined with Scotch® Rubber Mastic Tape 2228, provide a sealed jacket over cable splices installed on jacketed power cable. The Scotch® Rubber Mastic Tape 2228 helps assure a seal between the cable jacket and cold shrink foldback jacket tube. Mastic strips are also used to seal around the optional, external ground conductor. The cold shrink jacket tube is provided in an expanded state, mounted on two inner supporting cores. As supplied in this pre-stretched condition, the tube is ready for field installation. The jacketing tube is made from EPDM rubber that contains no chlorides or sulfurs. The completed jacket tube will be continuous from cable jacket to cable jacket, with no seams. Four kit sizes cover an application range from 4 AWG, 15 kV to sizes larger than 4/0 AWG, 35 kV.

Each kit contains sufficient materials to jacket one cable splice.

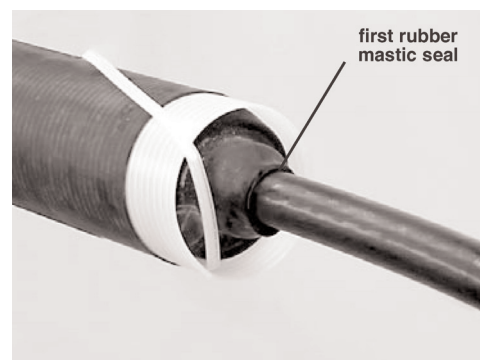

<b>Voltage</b>	15–35 kV
<b>Number of Conductors</b>	Single Conductor
<b>RoHS 2011/65/EU</b>	Yes

Order No.	UPC	Min. Cable Jacket O.D.	Max. Splice O.D.	Max. Cable Jacket Opening	Application Parking Space Required	Compatible With	Kits per Case
SJ-1FB	051128-55302	0.95" (24,1 mm)	2.00" (50,8 mm)	25.0" (635 mm)	20.0" (510 mm)	15 kV: 3M™ Splice No. 5411, 5411A, and 5412	6
SJ-2FB	051128-55303	1.15" (29,2 mm)	3.00" (76,2 mm)	31.0" (787,4 mm)	22.0" (560 mm)	15 kV: 3M™ Splice No. 5403, 5404, 5405, and 5406 25 kV: 3M™ Splice No. 5420, 5421, 5422, 5451, 5451A, and 5452 35 kV: 3M™ Splice No. 5432 and 5461	6
SJ-3FB	051128-55304	1.55" (39,4 mm)	3.62" (91,9 mm)	34.0" (863,6 mm)	24.0" (610 mm)	15 kV: 3M™ Splice No. 5407, 5408, and 5409 25 kV: 3M™ Splice No. 5423, 5424, 5425, and 5426 35 kV: 3M™ Splice No. 5433	6
SJ-4FB	051128-55305	1.75" (44,5 mm)	4.10" (104,1 mm)	32.0" (812,8 mm)	24.0" (610 mm)	-	6



## 3M™ Cold Shrink Splice Jacket Kits

3M™ Cold Shrink Splice Jacket Kits SJ Series are a series of open ended, tubular, rubber sleeves that combined with Scotch® Rubber Mastic Tape 2228 provide a sealed jacket over cable splices installed on jacketed power cable. The Scotch® Rubber Mastic Tape 2228 helps assure a seal between the cable jacket and the cold shrink jacket tube. It is also used to seal around a cable ground conductor. The cold shrink jacket tube is provided in an expanded state, mounted on two inner supporting plastic cores. As supplied in this prestretched condition, the tube is ready for field installation. The jacketing tube is made of EPDM rubber which contains no chlorides or sulfurs. Three kit sizes cover an application range of 0.95"-4.00" (24-102 mm).



<b>Voltage</b>	15–35 kV
<b>Number of Conductors</b>	Single Conductor
<b>RoHS 2011/65/EU</b>	Yes

Order No.	UPC	Application Parking Length	Application Installed Length	Min. Cable Jacket O.D.	Max. Splice O.D.	Max. Cable Jacket Opening	Compatible With	Kits per Case
SJ-1A	054007-69742	29.0" (737 mm)	23.0"-27.0" (584,2-685,8 mm)	0.95" (24,1 mm)	2.4" (61,0 mm)	20.0" (508 mm)	15 kV: 3M™ Splice No. 5411, 5411A, 5412, 5411R	6
SJ-2A	054007-69743	36.0" (914 mm)	32.0"-35.0" (813-889 mm)	1.15" (29,2 mm)	3.3" (83,8 mm)	28.0" (711 mm)	15 kV: 3M™ Splice No. 5403, 5404, 5405, and 5406 25 kV: 3M™ Splice No. 5420, 5421, 5422, 5451, and 5452 35 kV: 3M™ Splice No. 5432 and 5461	6
SJ-3A	054007-69744	38.0" (965 mm)	33.0"-37.0" (83,82-93,98 cm)	1.55" (39,4 mm)	4.0" (101,6 mm)	30.0" (762,0 mm)	15 kV: 3M™ Splice No. 5407, 5408, and 5409 25 kV: 3M™ Splice No. 5423, 5424, 5425, and 5426 35 kV: 3M™ Splice No. 5433	6

## 3M™ Cold Shrink Stacked Sleeve Splice Jacket Kits

3M™ Cold Shrink Stacked Sleeve Splice Jacket Kits SJ-SS Series are a series of open ended, tubular rubber sleeves that, combined with Scotch® Rubber Mastic Tape 2228 and a profile bushing, provide a sealed jacket over cable splices installed on jacketed power cable. The Scotch® Rubber Mastic Tape 2228 provides a seal between the cable jacket and cold shrink jacket tube. Mastic strips are also used to seal around an optional, external ground conductor. The cold shrink jacket tubes are provided in an expanded state, mounted on inner supporting plastic cores. As supplied in this prestretched condition, the tubes are ready for field installation. The jacketing tubes are made of EPDM rubber which contains no chlorides or sulfurs. Three kit sizes cover an application range of 0.95"–3.62" (24,1–92,0 mm).

Each kit jackets one cable splice.

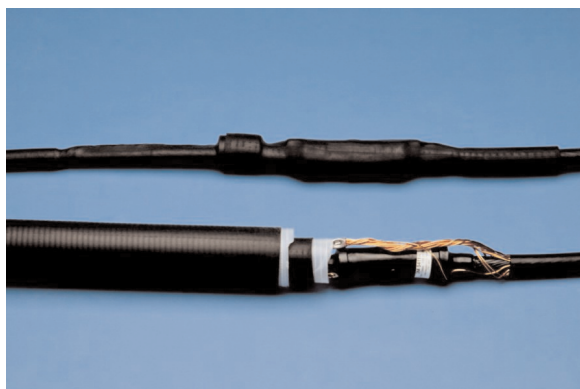

<b>Voltage</b>	15–35 kV
<b>Number of Conductors</b>	Single Conductor
<b>RoHS 2011/65/EU</b>	Yes

Order No.	UPC	Min. Cable Jacket O.D.	Max. Splice O.D.	Max. Cable Jacket Opening	Parking Space Required (approximate)	Compatible With	Kits per Case
SJ-1SS	054007-50777	0.95" (24,1 mm)	1.95" (49,5 mm)	23.0" (584 mm)	19.0" (483 mm)	15 kV: 3M™ Splice No 5411, 5411A, and 5412	6
SJ-2SS	054007-50778	1.15" (29,2 mm)	3.00" (76,2 mm)	31.0" (787 mm)	25.0" (635 mm)	15 kV: 3M™ Splice No. 5403, 5404, 5405, and 5406 25 kV: 3M™ Splice No. 5420, 5421, 5422, 5451, 5451A, and 5452 35 kV: 3M™ Splice No. 5432 and 5461	6
SJ-3SS	054007-50779	1.55" (39,4 mm)	3.62" (92,0 mm)	35.0" (889 mm)	26.0" (660 mm)	15 kV: 3M™ Splice No. 5407, 5408, and 5409 25 kV: 3M™ Splice No. 5423, 5424, 5425, and 5426 35 kV: 3M™ Splice No. 5433	6
SJ-1SSR	054007-41956	0.95" (24,1 mm)	1.95" (49,5 mm)	29.0" (737 mm)	25.0" (635 mm)	15 kV: 3M™ Splice No. 5411R	6
SJ-2SSR	054007-41957	1.15" (29,2 mm)	3.00" (76,2 mm)	37.0" (940 mm)	31.0" (787 mm)	15 kV: 3M™ Splice No. 5412R 25/28 kV: 3M™ Splice No. 5451R	6

## Splice Jacketing, Rejacketing and Cable Repair: 3M™ Splice Jacketing and Rejacketing Kits

### 3M™ Heat Shrinkable Splice Jacket Kits HSJ Series

3M™ Heat Shrinkable Splice Jacket Kits HSJ Series are designed to jacket power cable splices installed on jacketed power cable. The sleeves physically cover the cable neutral wires to environmentally protect the cable at the splice location. Fabricated from medium wall cross-linked polyolefin, the sleeves are flexible, highly split resistant and fast shrinking to provide rapid installation. The sleeves come with a factory applied adhesive/sealant. Sleeves are supplied in black only.

**Voltage** 15–35 kV  
**Number of Conductors** Single Conductor



Order No.	UPC	Sleeve Length	Expanded Sleeve I.D.	Min. Cable Jacket Diameter	Max. Splice Diameter	Max. Cable Jacket Opening	Compatible With	Kits per Case
HSJ-1	054007-09270	33.0" (838,2 mm)	2.50" (64 mm)	0.85" (22 mm)	1.90" (48,3 mm)	22.0" (559 mm)	15 kV: 3M™ Splice No 5411, 5411A and 5412	10
HSJ-2	054007-09271	40.0" (1016 mm)	3.00" (76,2 mm)	1.00" (25,4 mm)	2.60" (66,0 mm)	28.0" (711,2 mm)	15 kV: 3M™ Splice No. 5403, 5404, 5405, and 5406 25 kV: 3M™ Splice No. 5420, 5421, 5422, 5451, 5451A, 5452, and 5451R 35 kV: 3M™ Splice No. 5432 and 5461	10
HSJ-3	054007-09272	40.0" (1016 mm)	4.30" (109,2 mm)	1.50" (38,1 mm)	3.40" (86,4 mm)	28.0" (711,2 mm)	15 kV: 3M™ Splice No. 5407, 5408, and 5409 25 kV: 3M™ Splice No. 5423, 5424, 5425, and 5426 35 kV: 3M™ Splice No. 5433	5

## 3M™ Scotchcast™ Jacket Repair Kits M Series (up to 2 kV)

3M™ Scotchcast™ Jacket Repair Kits M Series contain a reusable wrap-around mold and accessory materials needed to make 10 permanent, flexible and moisture-resistant jacket repairs or splices of portable cable. The kit contains a wrap around mold that permits jacket repair without cutting through the cable. The M series kits, when used with 3M™ Scotchcast™ Flame-Retardant Compound 2131, provide durable, flexible jacket repair. Scotchcast kits can be used with portable power cable or standard cable.

Note: Scotchcast Flame-Retardant Compound 2131 needed to jacket the repair or splice is not included and must be ordered separately. U.S. Mine Safety and Health Administration acceptance No. 07-KA060007-MSHA.

<b>Voltage</b>	Up to 2 kV
<b>Cable/Shielding Type</b>	Shielded and Non-Shielded
<b>Splice Type</b>	Jacket Repair
<b>RoHS 2011/65/EU</b>	Yes
<b>Agency Approval</b>	07-KA060007-MSHA approved when used with Scotchcast Compound 2131.

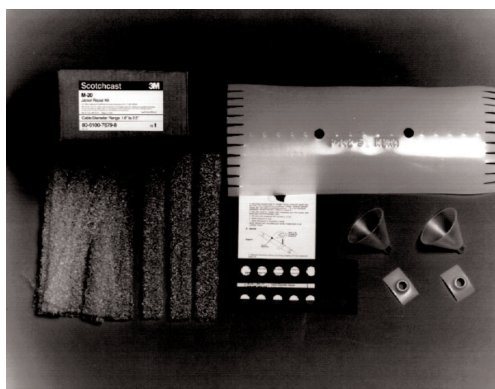

Order No.	UPC	Cable O.D.	Max. Repair Length	Case Qty.
M-20	051128-59223	1.60"-2.50" (41-63 mm)	13.0"-15" (330-381 mm)	1
M-30	051128-59224	1.85"-4.00" (47-102 mm)	20.0" (508 mm)	1
M-40	051128-59225	1.85"-6.00" (47-152 mm)	32.0" (813 mm)	1